

# BENNING



## Installation Tester **BENNING IT 130** Short instructions

GB: Detailed instruction manual on enclosed CD-Rom.

**Benning Elektrotechnik & Elektronik GmbH & Co. KG**  
**Münsterstraße 135 - 137**  
**D - 46397 Bocholt**  
**Phone: +49 (0) 2871 - 93 - 0 • Fax: +49 (0) 2871 - 93 - 429**  
**[www.benning.de](http://www.benning.de) • [duspol@benning.de](mailto:duspol@benning.de)**

© 05/2020 BENNING

This document must not be reproduced or used in any other form without the express written consent of BENNING.

## Table of Contents

1	Start-up guide.....	4
1.1	Safety and operational considerations .....	4
1.2	Front and connector panel.....	6
1.3	Standard scope of delivery .....	7
1.4	Indications and meaning of symbols .....	8
1.5	Selecting measuring functions.....	9
1.6	Switch position „AUTO“ .....	10
1.7	Settings.....	10
1.8	Measured value memory .....	10
1.9	Batteries and fuses .....	11
1.10	Calibration and Service .....	12
1.11	Optional accessories .....	13
2	Measurements.....	14
2.1	Null balance (compensation) of the test cables.....	14
2.2	TRMS voltage (V AC/DC), frequency and phase sequence (rotary field) .....	15
2.3	Insulation Resistance ( $R_{ISO}$ ) .....	16
2.4	Low-impedance resistance ( $R_{LOW}$ )/ continuity test.....	17
2.5	Residual current operated device (RCD) .....	18
2.6	Loop impedance ( $Z_{S L-PE}$ ) .....	19
2.7	Line impedance ( $Z_{I L-N/L}$ ) .....	20
2.8	Earth resistance ( $R_E$ ).....	21
2.9	Current (A AC/DC) .....	22
2.10	Luminous intensity (LUX).....	23
2.11	First fault current ( $R_{ISO}$ ) in IT supply system (ISFL) .....	24

# 1 Start-up guide

## 1.1 Safety and operational considerations

The following symbols are used in the user manual and on the test equipment:



Important, danger, must comply with documentation!



Warning of electrical danger!



Protection class II



Ground (voltage to earth)



Warnings related to safety – general information

- This document is not a supplement to the Instruction manual! Please find the operating manual as PDF file on the enclosed CD-ROM.
- If the test equipment is used in a manner not specified in this user manual, the protection provided by the equipment could be impaired!
- Read this user manual carefully, otherwise the use of the instrument may be dangerous for the operator, the instrument or for the equipment under test!
- Do not use the instrument or any of the accessories if any damage is noticed!
- Consider all generally known precautions in order to avoid risk of electric shock while dealing with hazardous voltages!
- If the fuse F1 has blown, please follow the instructions of this operating manual to replace it! Only use a fuse complying with the specification (see chapter 7.1) as replacement.  
If one of the fuses F2 or F3 has blown, the device must not be used anymore. In this case, the device must be sent to BENNING for inspection and repair.
- Do not use the instrument in AC supply systems with voltages higher than 550 V AC.
- Service, repairs or adjustment of instruments and accessories is only allowed to be carried out by a competent authorized personnel!
- Please use standard or optional BENNING accessories only which are available from your authorized specialty retailer!
- Consider that protection category of some accessories is lower than of the instrument. Test tips and Tip "Commander" have removable caps. If they are removed the protection falls to CAT II. Check markings on accessories!  
cap off, 18 mm tip: CAT II up to 1000 V to earth  
cap on, 4 mm tip: CAT II 1000 V / CAT III 600 V / CAT IV 300 V to earth
- The instrument come supplied with rechargeable NiMh battery cells. The cells should only be replaced with the same type as defined on the battery compartment label or as described in this manual. Do not use standard alkaline battery cells while the power supply adapter is connected, otherwise they may explode!
- Hazardous voltages exist inside the instrument. Disconnect all test leads, remove the power supply cable and switch off the instrument before removing battery compartment cover.
- Do not connect any voltage source on C1 input. It must be used only for connecting the current clamp adapters recommended by BENNING. Maximal input voltage is 3 V!
- All normal safety precautions must be taken in order to avoid risk of electric shock while working on electrical installations!



### Warnings related to safety – measurements

#### Insulation resistance

- ❑ Insulation resistance measurement should only be performed on de-energized objects!
- ❑ Do not touch the test object during the measurement or before it is fully discharged! Risk of electric shock!
- ❑ When an insulation resistance measurement has been performed on a capacitive object, automatic discharge may not be done immediately! The warning message  and the actual voltage (Udisch) are displayed during discharge until voltage drops below 30 V.
- ❑ Do not connect test terminals to external voltage higher than 600 V (AC or DC) in order not to damage the test instrument!

#### Low-impedance resistance/continuity test

- ❑ Low-impedance resistance measurements/ continuity tests should only be performed on de-energized objects!
- ❑ Parallel loops may influence on test results.

#### Testing PE terminal

- ❑ If the phase voltage is detected at the protective conductor connection PE, immediately stop all measurements and ensure that the fault of the installation will be eliminated.



### Warnings related to safety – batteries/ storage batteries and fuses

- ❑ Disconnect all test cables / accessories from the tester and from the installation and switch the tester off before opening the cover of the battery / fuse compartment. Dangerous voltages may be applied to the interior of the tester!
- ❑ Please make sure that the storage batteries are inserted correctly, because otherwise the tester is not ready for operation and the storage batteries will discharge.
- ❑ Do not recharge alkaline battery cells!
- ❑ The storage batteries must be charged only by means of the charger included in the scope of delivery!



### Warnings related to safety – "Commander" probe tip (included in delivery) – "Commander" test plug for shock-proof socket (optional)

Measuring category of commanders:

"Commander" probe tip (cap off, 18 mm tip)	CAT II 1000 V to earth
"Commander" probe tip (cap on, 4 mm tip)	CAT II 1000 V / CAT III 600 V / CAT IV 300 V to earth
"Commander" test plug for shock-proof socket	CAT II 300 V to earth

- ❑ Measuring category of commanders can be lower than protection category of the instrument.
- ❑ If dangerous voltage is detected on the tested PE terminal, immediately stop all measurements, find and remove the fault!
- ❑ Disconnect the "Commander" from the tester and from the installation and switch the "Commander" off before opening the cover of the battery compartment. Dangerous voltages might occur inside the "Commander"!

## 1.2 Front and connector panel

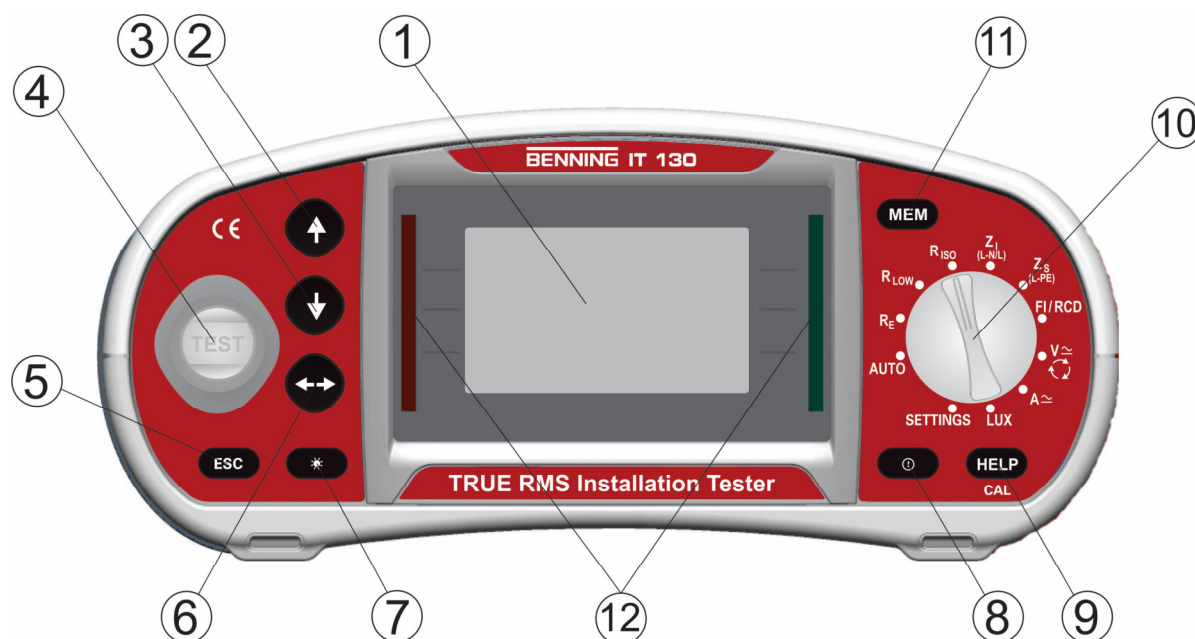

Legend:

1	<b>LCD</b>	<input type="checkbox"/> 128 x 64 dots matrix display with backlight.
2	<b>UP</b>	<input type="checkbox"/> Modifies selected parameter.
3	<b>DOWN</b>	<input type="checkbox"/> Starts measurements.
4	<b>TEST</b>	<input type="checkbox"/> Acts also as the PE touching electrode.
5	<b>ESC</b>	<input type="checkbox"/> Goes one level back.
6	<b>TAB</b>	<input type="checkbox"/> Selects the parameters in selected function.
7	<b>Backlight, Contrast</b>	<input type="checkbox"/> Changes backlight level and contrast.
8	<b>ON/OFF</b>	<input type="checkbox"/> Switches the instrument power on or off. The instrument automatically turns off 15 minutes after the last key was pressed.
9	<b>HELP/CAL</b>	<input type="checkbox"/> Help function with connection diagrams (press for approx. 2 seconds for R LOW and $\Delta U$ ) <input type="checkbox"/> For calibrating the test cables in the R LOW and CONTINUITY function <input type="checkbox"/> Starts the $Z_{REF}$ measurement in the sub-function $\Delta U$ voltage drop
10	<b>Function selector switch</b>	<input type="checkbox"/> Selects test function.
11	<b>MEM</b>	<input type="checkbox"/> Stores / recalls memory of instrument. <input type="checkbox"/> Stores the settings of the current clamp adapter
12	<b>Green LEDs Red LEDs</b>	<input type="checkbox"/> Indicates PASS / FAIL of result.

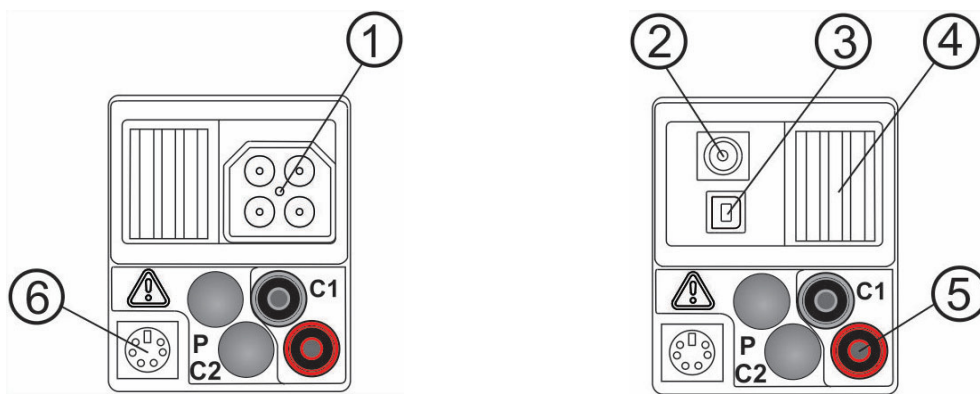

Legend:

1	<b>Test connector</b>	Measuring inputs / outputs.
2	<b>Charger socket</b>	For charging the rechargeable NiMh storage batteries
3	<b>USB connector</b>	USB interface for PC connection
4	<b>Protection cover</b>	
5	<b>C1</b>	Measuring input for optional current clamp adapter BENNING CC 1 / BENNING CC 3
6	<b>PS/2 connector</b>	Serial RS-232 interface for PC connection Connection for optional measuring adapters, e.g. BENNING luxmeter type B Connection for optional barcode scanner

### 1.3 Standard scope of delivery





- 1 x BENNING IT 130 installation tester
- 1 x padded carrying case (item no. 10008291)
- 1 x "Commander" test probe (switchable by means of "TEST" key) (item no. 044155)
- 1 x test cable with shock-proof plug (item no. 10008295)
- 1 x universal three-wire test cable (black, blue, green) (item no. 10008296)
- 1 x set of test probes (black, blue, green) (item no. 10008304 - 10008306)
- 1 x set of alligator clips (black, blue, green) (item no. 10008301 - 10008303)
- 1 x carrying strap (item no. 10008290)
- 1 x RS 232-PS/2 interface cable (item no. 10008313)
- 1 x USB interface cable (item no. 10008312)
- 6 x rechargeable NiMh storage batteries of size AA
- 2 x batteries of size AAA
- 1 x charger (item no. 10008308)
- 1 x CD-ROM with BENNING PC-WIN IT 130 logging software, operating manual and quick reference guide in PDF format
- 1 x quick reference guide
- 1 x calibration certificate





## 1.4 Indications and meaning of symbols

### Terminal voltage monitor











The terminal voltage monitor displays on-line the voltages on the test terminals and information about active test terminals in the AC installation measuring mode.

	The voltage applied is displayed by means of the testing terminal symbol. All three testing terminals L, N and PE are used for the selected measurement.
	The voltage applied is displayed by means of the testing terminal symbol. The testing terminals L and N are used for the selected measurement.
	The testing terminals L and PE are active testing terminals. The testing terminal N should be connected as well in order to have a correct input voltage.
	The polarity of the testing voltage applied (R LOW, R ISO) is displayed at the output terminals L and N.









### Battery indication

	Battery capacity indication.
	Low battery. The storage battery charge condition is too low to ensure correct measuring results. Recharge the storage batteries or replace the batteries.
	Charging in progress (if power supply adapter is connected).

### Messages

	Measurement is running, consider displayed warnings.
	Conditions on the input terminals allow starting the measurement; consider other displayed warnings and messages.
<b>DC VOLTAGE! Warning!</b> Too high DC voltage (> 50 V DC) applied to the testing terminals!	
	Conditions on the input terminals do not allow starting the measurement, consider displayed warnings and messages.
	RCD tripped-out during the measurement (in RCD functions).
	Portable RCD selected (PRCD).
	Instrument is overheated. The measurement is prohibited until the temperature decreases under the allowed limit.
	RCD of type EV (Electric Vehicle)
	RCD of type MI (Mobile Installation)
	Result(s) can be stored.
	High electrical noise was detected during measurement. Results may be impaired.
	L and N are changed.





	<b>Warning!</b> High voltage is applied to the test terminals.
	<b>Warning!</b> Dangerous voltage on the PE terminal! Stop the activity immediately and eliminate the fault / connection problem before proceeding with any activity!
	The test cable resistance for the low-impedance measurement / continuity test has not been compensated.
	High resistance to earth of test probes. Results may be impaired.
	The current is too low for the accuracy specified. This might result in incorrect measuring results. Please check in the current clamp settings whether the accuracy of the current clamp can be increased.
	Measured signal is out of range (clipped). Results are impaired.
	Simple error in the IT network.
	Fuse F1, F2 or F3 is defective. If one of the fuses F2 or F3 has blown, the device must not be used anymore. In this case, the device must be sent to BENNING for inspection and repair.





**Sound warnings**

Continuous sound	<b>Warning!</b> Dangerous voltage on the PE terminal is detected.
------------------	---

**Evaluation of the measuring result**

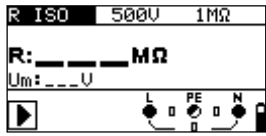
	Measurement result is inside pre-set limits (green LEDs).
	Measurement result is out of pre-set limits (red LEDs).
	Measurement is aborted. Consider displayed warnings and messages.

**1.5 Selecting measuring functions**

	Rotary switch for selecting the measuring function	
	Selects sub-function	
	Selects value of parameter / limit	
	Selects parameter / limits	
	Starts measurement	

## 1.6 Switch position „AUTO“

Turn the rotary selector switch to the "AUTO" position in order to select the measuring function by means of the "Commander" probe tip (044155) or by means of the optional "Commander" test plug (044149).

The following functions can be selected by means of the "Commander":

- selection of the measuring function (only in the "AUTO" switch position)
- start of measurement
- storage of measuring results
- LC display illumination ON/OFF
- measuring point illumination ON/OFF

## 1.7 Settings

Turn the rotary selector switch to the "SETTINGS" position in order to make the following settings at the tester:

- MEMORY (request data, delete data, delete entire memory)
- SELECT LANGUAGE (GB, D, E, F, NL)
- SET DATE/TIME
- EARTHING SYSTEM (TN/TT or IT network)
- RCD TESTING (according to EN 61008/EN 61009, IEC 60364-4-41, BS 7671, AS/NZS 3017)
- SET ISC FACTOR setting (0.20 - 3.00)
- SELECT COMMANDER (ON/OFF)
- INITIAL SETTINGS
- CLAMP SETTINGS (BENNING CC 1 (044037) , BENNING CC 3 (044038))

## 1.8 Measured value memory

The internal memory of the tester allows to store up to 1800 measuring results including parameters, limiting values and date/time of the measurement.

The measuring results can be stored in a memory structure comprising 4 levels:

Memory structure:

- [OBJ] OBJECT 001
- [BLO] BLOCK 001
- [FUS] FUSE 001
- [CON] MEASURING POINT 001

Example of installation structure:

customer Meyer  
distributor of ground floor  
F1 kitchen  
socket 1

Measurement: no.: 1/3 RCD I: 22.5 mA  
no.: 2/3 R ISO: >999 MΩ  
no.: 3/3 R LOW: 0.17 Ω

The PC software BENNING PC-Win IT 130 (included in the delivery) serves to read the memory of measured values of the tester (download) and to transmit installation structures that have already been created on the PC to the tester (upload).

## 1.9 Batteries and fuses

### Batteries

#### Warning:



- ❑ Disconnect all test cables / accessories from the tester and from the installation and switch the tester off before opening the cover of the battery / fuse compartment. Dangerous voltages might occur inside the tester!
- ❑ Use alkaline batteries or rechargeable NiMh batteries (storage batteries) of the size AA only! Do not recharge alkaline batteries!
- ❑ Please make sure that the batteries / storage batteries are inserted with correct polarity, because otherwise the tester cannot be operated and the batteries / storage batteries will discharge.
- ❑ If the tester will not be used for a longer period of time, remove all batteries / storage batteries from the battery compartment in order to protect the tester against leakage of the batteries / storage batteries.

The rechargeable NiMh batteries (storage batteries) will be recharged automatically as soon as the charger is connected to the charging socket. An integrated protective circuit controls the charging process.



*Power supply socket polarity*

#### Note:

- ❑ Before the first use! Insert the storage batteries into the battery compartment and charge the storage batteries for at least 16 hours.

### Fuses

#### Warning:



- ❑ Disconnect all test cables / accessories from the tester and from the installation and switch the tester off before opening the cover of the battery / fuse compartment. Dangerous voltages may be applied to the interior of the tester!
- ❑ Three fuses are located behind the rear cover of the installation tester. Only the fuse F1 can be replaced.

If one of the fuses F2 or F3 has blown, the device must not be used anymore. In this case, the device must be sent to BENNING for inspection and repair.

#### ❑ F1

M 0,315 A / 250 V, 20×5 mm

This fuse is intended to protect the internal switching circuits for low-impedance measurement/ continuity test, if during measurement the probe tips are accidentally connected to the mains voltage.

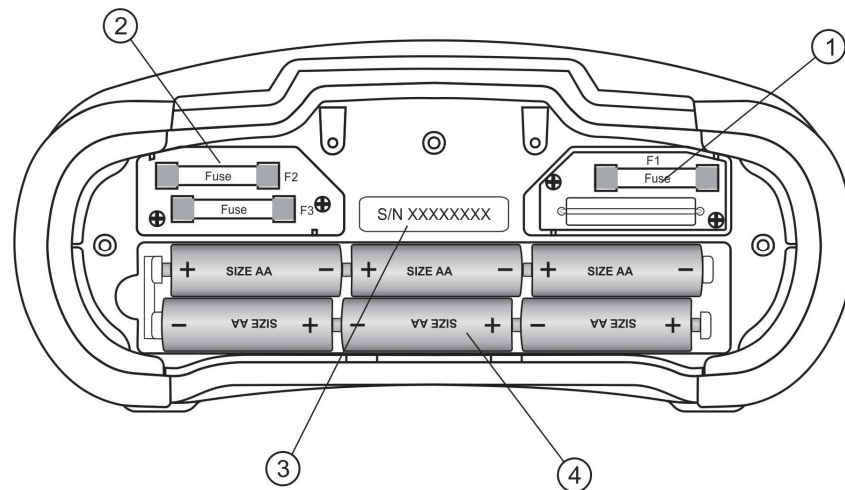

Legend:

1	<b>Fuse F1</b>	M 315 mA / 250 V
2	<b>Fuses F2 and F3</b>	If one of the fuses F2 or F3 has blown, the device must not be used anymore. In this case, the device must be sent to BENNING for inspection and repair.
3	<b>Serial number label</b>	
4	<b>Storage batteries/ batteries</b>	Size AA, rechargeable NiMh / alkaline quantity: 6 pieces

## 1.10 Calibration and Service

### Calibration

Benning guarantees compliance with the technical and accuracy specifications stated in the operating manual for the first 12 months after the delivery date.

To maintain accuracy of the measuring results, the device must be recalibrated in regular intervals by our factory service. We recommend recalibrating the device once a year. In case of need, please contact our service.







### Service

Please do not hesitate to contact our specialists for any further information.

BENNING Elektrotechnik & Elektronik GmbH & Co KG  
 Robert-Bosch-Str. 20  
 D - 46397 Bocholt  
 Internet: [www.benning.de](http://www.benning.de)

BENNING Helpdesk phone no.: +49 (0) 2871 - 93 - 555

## 1.11 Optional accessories

<p><b>Earthing set</b> Earthing set consisting of 2 earth rods and 3 test cables 2 x L = 20 m, 1 x L = 4.5 m 044113</p>	
<p><b>Current clamp adapter</b> <b>BENNING CC 1</b>, 1 A - 400 A AC output: 1 mV per 1 A 044037 <b>BENNING CC 3</b>, 0.2 A - 300 A AC/DC output: 1 mV/10 mV per 1 A 044038</p>	
<p><b>Luminous intensity sensor</b> <b>BENNING luxmeter type B</b> 044111 For the planning and installation of interior and exterior lighting</p>	
<p><b>"Commander" test plug</b> For shock-proof socket, switchable with "TEST" and "MEM" keys, with "PASS" / "FAIL" indication by means of green/red LED, PE contact electrode for detecting a phase voltage at the protective conductor connection (PE) 044149</p>	
<p><b>CEE measuring adapter</b> 16 A, 5-pin, for measuring the voltage and phase sequence (rotary field) at 16 A CEE sockets 044148</p>	
<p><b>40 m Measurement cable</b> 40 m measurement cable with winder and strap, for the measurement of protective conductors 044039</p>	
<p><b>Barcode scanner</b> Barcode scanner with PS/2 interface for identifying the measuring point and renaming the storage location 009371</p>	

## 2 Measurements

### 2.1 Null balance (compensation) of the test cables

#### 1. Set function



Select R LOW  $\Omega$  or CONTINUITY.

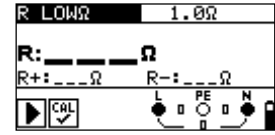

Short-circuit the test cables.

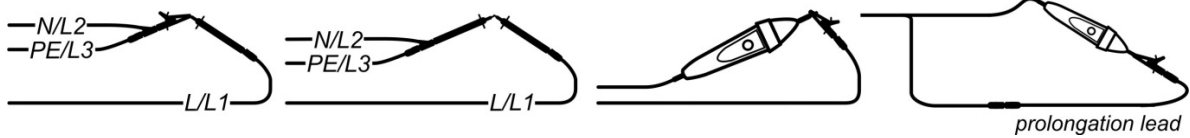

Shorted test leads



#### 3. Press the key

#### 4. Press the key CAL (HELP).

After performing test leads compensation first measured value and then 0.00  $\Omega$  is displayed.

Successful compensation is displayed by means of the  symbol in the "R LOW" and "CONTINUITY" function.

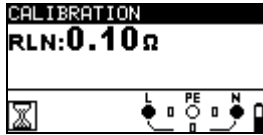

Resistance of the test cable before compensation

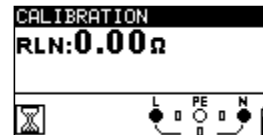

Resistance of the test cables after compensation

## 2.2 TRMS voltage (V AC/DC), frequency and phase sequence (rotary field)

### 1. Set function

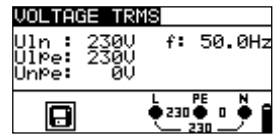

### 2. Connection diagrams

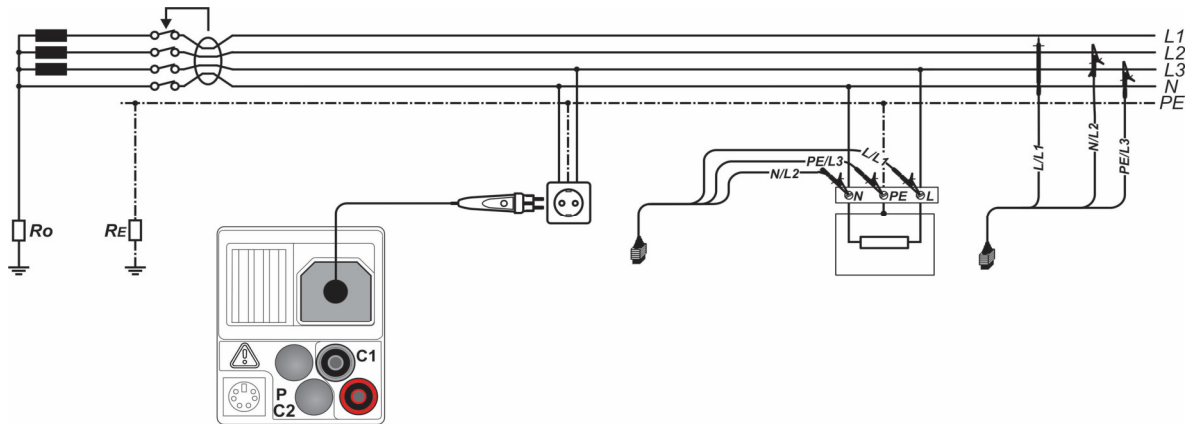

Connection of "Commander" test plug (optional) and 3-wire test lead in single-phase system

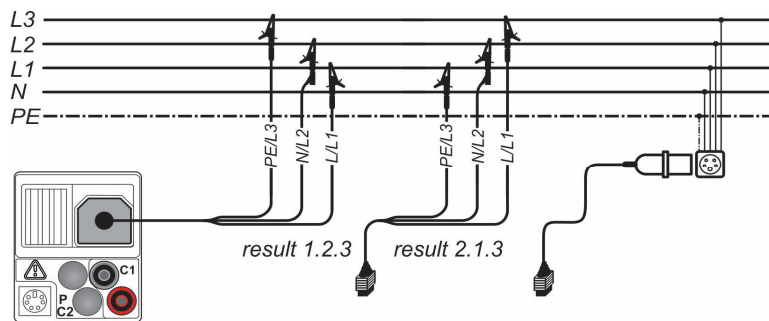

Connection of the three-wire test cable and of the three-phase adapter (optional) in a three-phase system

### 3. The measuring result can be stored by means of the "MEM" key.

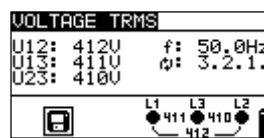
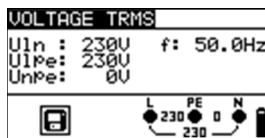

**Uln** ..... Voltage between phase (L) and neutral conductors (N)  
**Uipe** ... Voltage between phase (L) and protective conductors (PE)  
**Unpe**.. Voltage between neutral (N) and protective conductors (PE)  
**f**..... Frequency

**U12** .... Voltage between phases L1 and L2  
**U13** .... Voltage between phases L1 and L3  
**U23** .... Voltage between phases L2 and L3  
**1.2.3** ... Clockwise phase sequence: OK  
**3.2.1** ... Counter-clockwise phase sequence: not OK  
**f**..... Frequency



### 2.3 Insulation Resistance ( $R_{ISO}$ )

**1. Set function**



**R ISO**

**2. Set parameters and limits.**

  
  

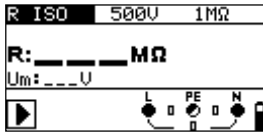

**Test voltage**  
 [50 V, 100 V, 250 V, 500 V, 1000 V]

**Minimum limiting value**  
 [without (---), 0.01 MΩ ÷ 200 MΩ]

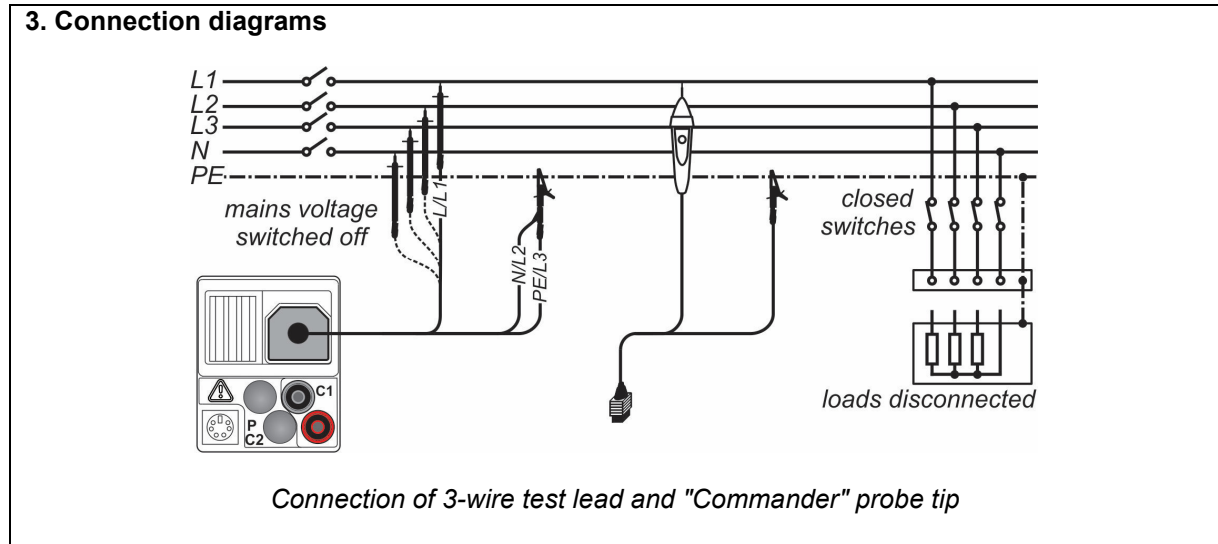



**4. Press and hold the key  until result is stabilized.**

**Double-click  to start continuous measurement.**

**5. The measuring result can be stored by means of the "MEM" key.**



**R** .....Insulation resistance  
**Um** .....Test voltage (actual value)



## 2.4 Low-impedance resistance ( $R_{LOW}$ )/ continuity test

**1. Set function**



**R LOW**

**2. Set sub-function and limit.**

**R LOW**  $\Omega$  low-impedance resistance (testing current > 200 mA) or **CONTINUITY** (testing current < 8.5 mA)

**Maximum limiting value**  
[without (---), 0.1  $\Omega$  ÷ 20.0  $\Omega$ ]

**Buzzer [ON/OFF]** only for CONTINUITY function

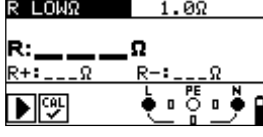

**3. Connection diagrams**

MPEC...Main Potential Equilizing Collector  
PCC...Protection Conductor Collector

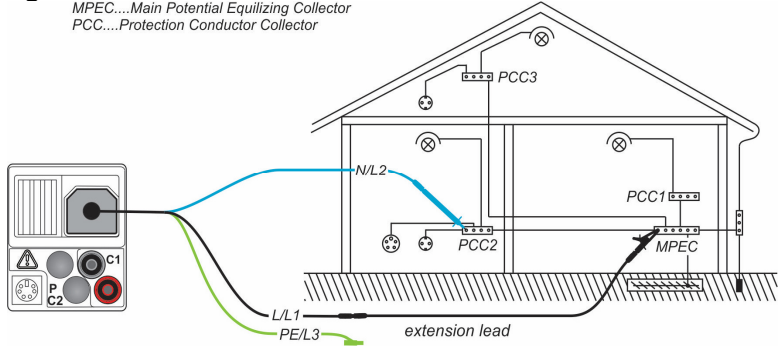

Connection of the three-wire test cable and of the optional measuring line BENNING TA 5 (044039)

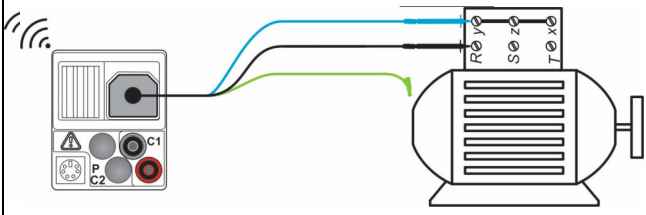

Connection of 3-wire test lead and "Commander" probe tip

**4.a R LOW  $\Omega$  low impedance**

Press the key  .

**4.b CONTINUITY:**

Press the key  to begin performing a continuous measurement.  
Press the key **TEST** again to stop measurement.

**5. The measuring result can be stored by means of the "MEM" key.**

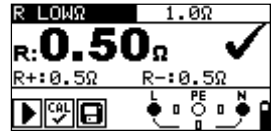

R .....R LOW  $\Omega$   
R+ .....Result at positive polarity  
R- .....Result at negative polarity

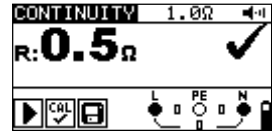

R ..... CONTINUITY resistance

## 2.5 Residual current operated device (RCD)

**1. Set function**



RCD

**2. Set sub-function, parameters and limits.**

RCD I Tripping current  
 RCD t Tripping time  
 Uc Contact voltage  
 AUTO automatic test

**Nominal tripping differential current  $I_{\Delta N}$**   
 [10/30/100/300/500/1000 mA].

**RCD type** [AC, A, F, B, B+]

**Starting polarity** [~, ~, ~, ~, ~, ~, ~, ~]

**Characteristic** [selective , general non-delayed , PRCD, PRCD-S, PRCD-K, EV RCD, MI RCD]

**Multiplication factor for test current**  
 [ $1/2 \times I_{\Delta N}$ ,  $1/2/5 \times I_{\Delta N}$ ].

**Limiting value for contact voltage**  
 [25 V, 50 V].

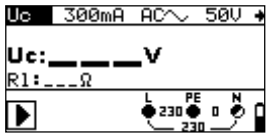
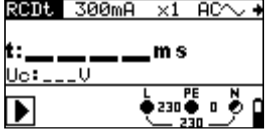
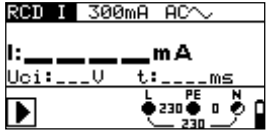
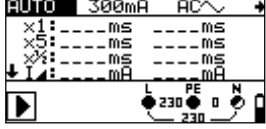

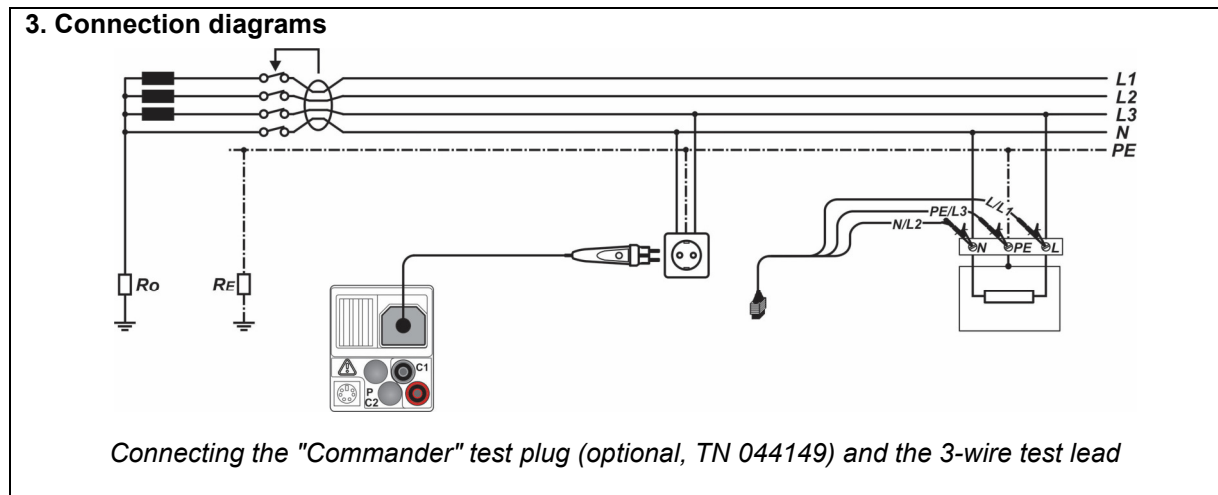
**4. Press the key** 

**5. The measuring result can be stored by means of the "MEM" key.**

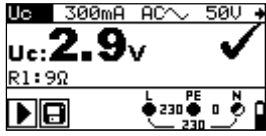

**Uc** .....Contact voltage  
**RL** .....Fault loop resistance

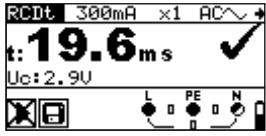

**t** ..... Tripping time  
**Uc** .... contact voltage for nominal value  $I_{\Delta N}$



**I** ..... Tripping current  
**Uci** .... Contact voltage at trip-out current I or end value in case the RCD didn't trip  
**t** ..... Tripping time

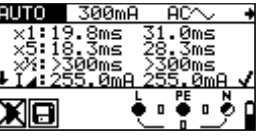

Measuring values for 0°/180°:  
**x1** ... Tripping time  $I_{\Delta N}$   
**x5** ... Tripping time  $5 \times I_{\Delta N}$   
**x1/2** .. Tripping time  $1/2 \times I_{\Delta N}$   
**I** ..... Tripping current  
**Uc** ... Contact voltage for  $I_{\Delta N}$

## 2.6 Loop impedance ( $Z_{s\ L-PE}$ )

**1. Set function**



**Z<sub>s</sub>**

**2. Set sub-function, parameters and limits.**



Loop impedance:  
**Z<sub>s</sub>** (for systems without RCD)  
**Z<sub>s rcd</sub>** (for systems with RCD)  
**Fuse type** [---, gL/gG, gG, B, C, K, D]  
**Nominal current** of the fuse  
**Tripping time** of the fuse

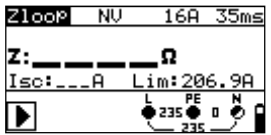

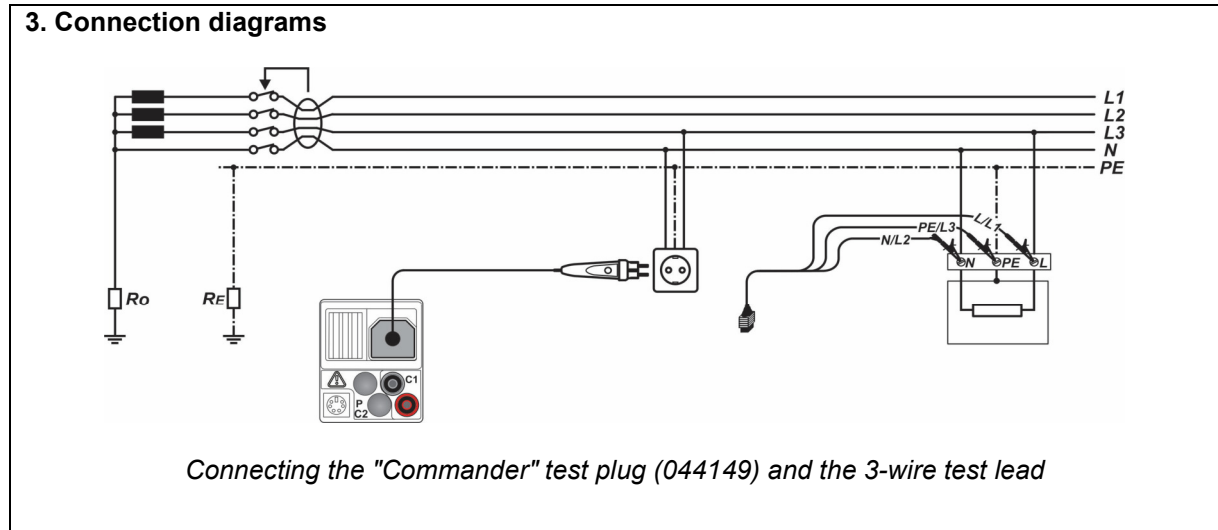

**4. Press the key** 

**5. The measuring result can be stored by means of the "MEM" key.**

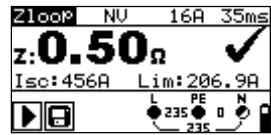

**Z<sub>s</sub>**.....Loop impedance (L-PE)  
**Isc**.....prospective short-circuit current (fault current)  
**Lim**...lower limiting value of the prospective short-circuit current

## 2.7 Line impedance ( $Z_{L-N/L}$ )

**1. Set function**



**Z<sub>L</sub>**

**2. Set sub-function, parameters and limits.**

**Z Line** Line impedance  
**ΔU** Voltage drop

**Fuse type**  
 [---, gL/gG, gG, B, C, K, D]  
**Nominal current of the fuse**  
**Turn-off time of the fuse**  
**Maximum voltage drop [3,0 % ÷ 9,0 %]**

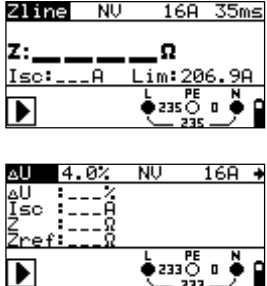

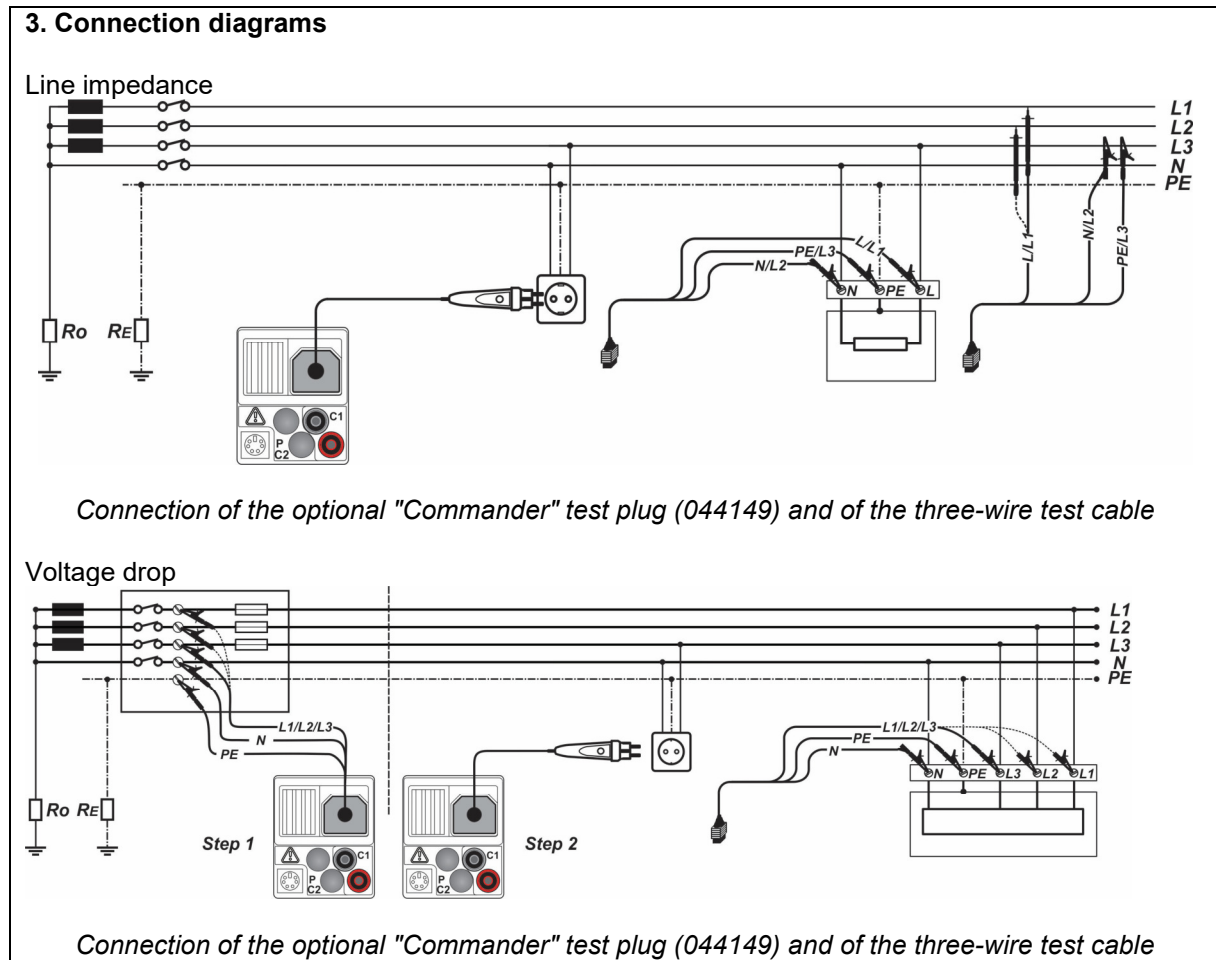

**4. Press the key** 

**5. The measuring result can be stored by means of the "MEM" key.**

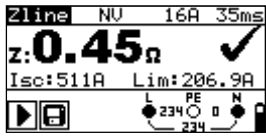

**Z:** .....Line impedance  
**Isc**.....Prospective short-circuit current  
**Lim** ...Lower limiting value of the prospective short-circuit current

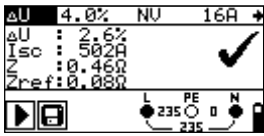

**ΔU**.... Voltage drop  
**Isc**.... Prospective short-circuit current  
**Z**..... Line impedance at the measuring point  
**Zref**.. Line impedance of the reference point

## 2.8 Earth resistance ( $R_E$ )

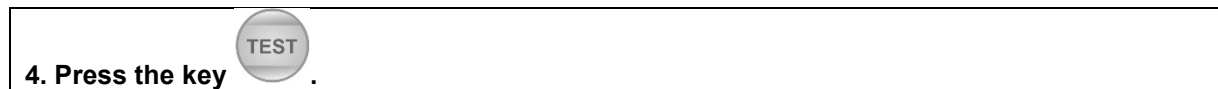
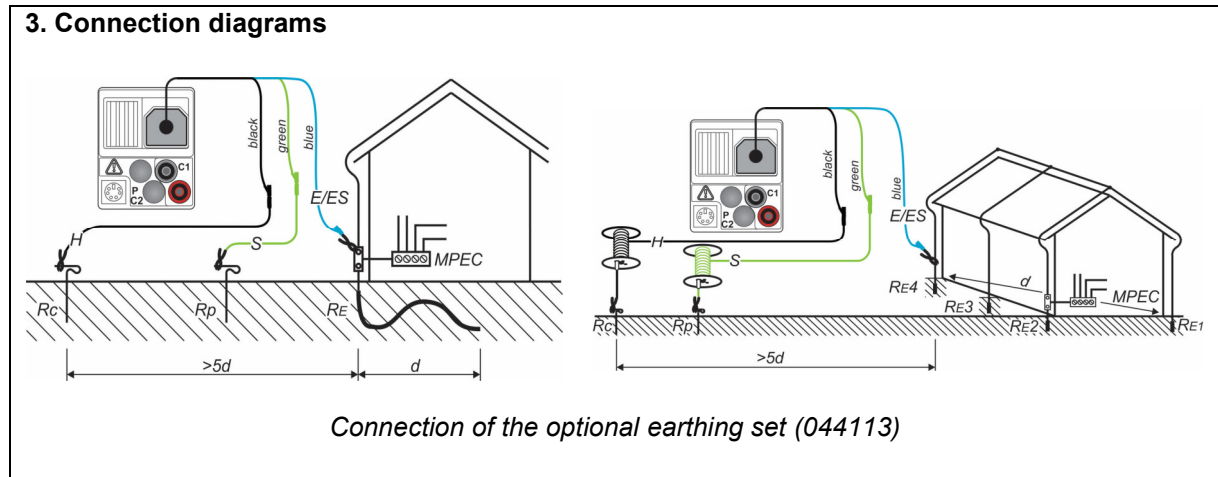
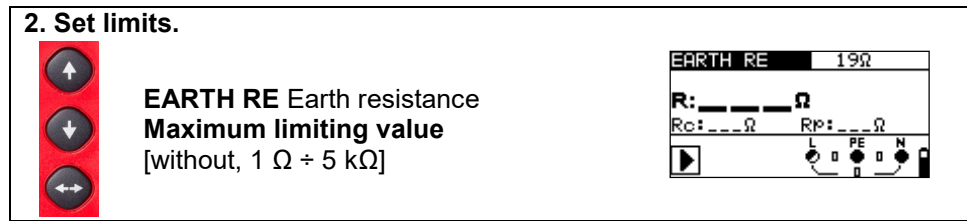
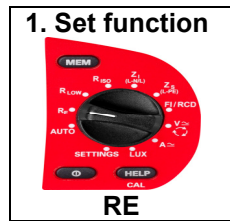

**5. The measuring result can be stored by means of the "MEM" key.**

R .....Earth resistance  
 Rp .....Probe resistance of the S probe (potential)  
 Rc .....Auxiliary earth electrode resistance of the H probe (current)

## 2.9 TRMS Current (A AC/DC)

### 1. Set function



**Note:**  
Please set the current clamp adapter used under "SETTINGS".

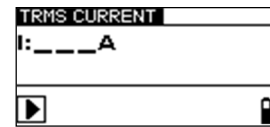

### 2. Connection diagrams

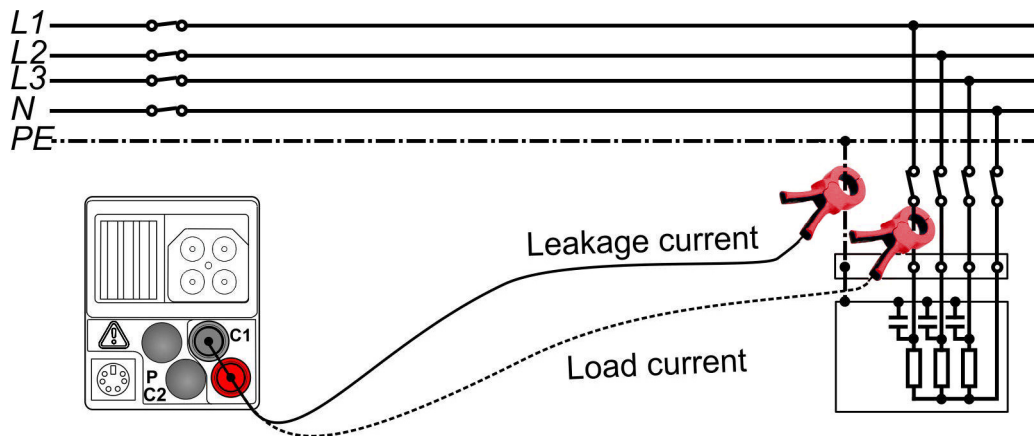

Connection of the optional current clamp adapter BENNING CC 1 (044037) , BENNING CC 3 (044038)

### 4. Press the key



### 5. The measuring result can be stored by means of the "MEM" key.

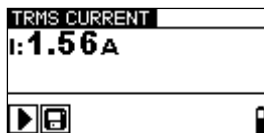

I.....Current

## 2.10 Luminous intensity (LUX)

**1. Set function**



**LUX**



**2. Set limit.**

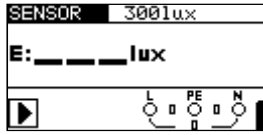

**Minimum illumination**  
[OFF, 0.1 lux ÷ 20 klux]

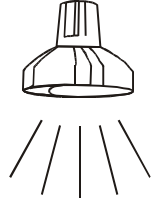

**3. Connection diagrams**

*Positioning of the luminous intensity sensor BENNING luxmeter type B (044111)*

**4. Press the key**  .

**5. The measuring result can be stored by means of the "MEM" key.**

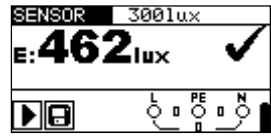

**E** .....Luminous intensity

## 2.11 First fault current ( $R_{ISO}$ ) in IT supply system (ISFL)

**1. Set function**



**R<sub>iso</sub>**

**2. Set sub-function and limit.**



ISFL Single-fault leakage current  
(only in IT networks)  
**Maximum limiting value**  
[without, 3.0 mA ÷ 20.0 mA]

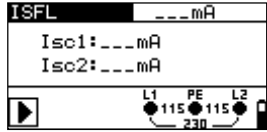

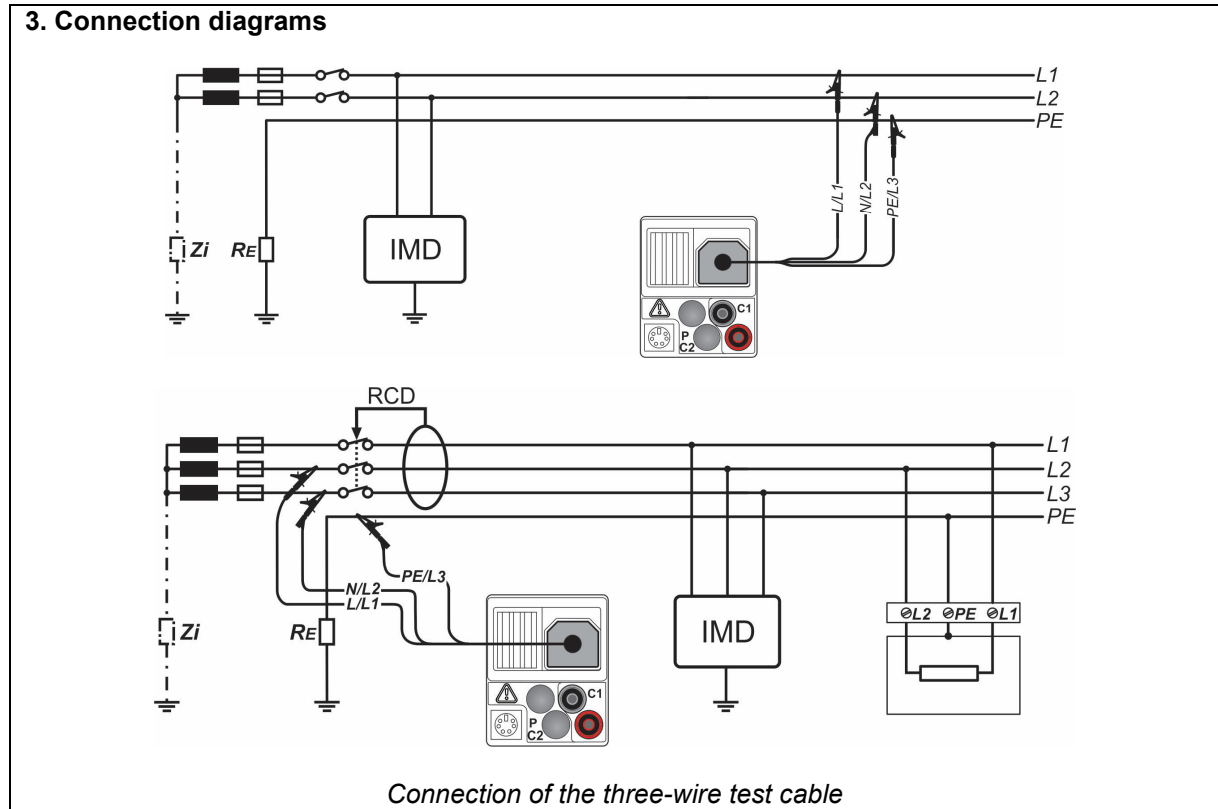

**4. Press the key**  .

**5. The measuring result can be stored by means of the "MEM" key.**

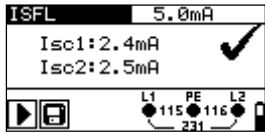

Isc1 ...Single-fault current between L1 and PE  
Isc2 ...Single-fault current between L2 and PE