

PV Hybrid Inverter
SPE 12000 ES
SPE 10000 ES
SPE 8000 ES



044.SK0014900

Version: 1.0

Table Of Contents

1.Information on this Manual	1
1.1 Validity	1
1.2 Scope	1
1.3 Target Group	1
1.4 Safety Instructions	1
2. Product Overview	2
2.1 Product Features	2
2.2 Panel and Port Definitions	3
3. Installation Instructions	4
3.1 Accessory list	4
3.2 Points for attention	4
3.3 Battery Connection	5
3.3.1 Wiring preparation	5
3.3.2 Battery power cable connection	5
3.3.3 Lithium battery communication cable connection	6
3.4 AC Connection	7
3.4.1 Connection preparation	7
3.4.2 Grid/GEN/ Load/ Smart Load wires Connection	7
3.5 PV Connection	9
3.5.1 Connection preparation	9
3.5.2 PV cable Connection:	9
3.6 Communication Connection	10
3.7 Dry Contact Signal	10
3.8 CT Connection	10
3.9 Wiring system for inverter	11
4. Operation	12
4.1 Power ON/OFF	12
4.2 Display Panel Introduction	12
4.2.1 LCD Display Icons	13
4.2.2 Display Information	14
4.2.3 Operating Mode Description	17
4.3 LCD parameter setting	18
4.3.1General settings	18
4.3.2Hide settings	30
5. Parallel Installation Guide	32
5.1 Parallel accessories	32
5.2 Points of Attention for Parallel	32
5.3 Wire Connections	32
5.3.1 Single-phase parallel wire connection	32

5.3.2 Three-phase parallel wire connection	34
5.3.3 CT wire connection	35
5.4 Parallel Example	36
5.5 Parallel setup and display	37
5.6 Example of a parallel system diagram	38
6. Fault Reference Code	40
6.1 Fault Reference Code	40
6.2 Warning Indicator	41
7. Specifications	42
7.1 PV Specification	42
7.2 AC Input Specification	42
7.3 Grid Feeding Specification	42
7.4 Battery Mode Specification	43
7.5 Two Load Output Power Specification	43
7.6 Overload Capability Specification	43
7.7 Battery & Charger Specification	44
8. Appendix	46
Appendix I. Fault information and processing	46
Appendix II Restore factory settings	48
Appendix III Battery Equalization	48
Appendix IV Routine maintenance	50
Appendix V WIFI Monitoring	50

1.Information on this Manual

1.1 Validity

This manual is valid for the following devices:

- ▶ SPE 12000 ES
- ▶ SPE 10000 ES
- ▶ SPE 8000 ES

1.2 Scope

This manual describes the assembly, installation, operation and troubleshooting of this unit. Please read this manual carefully before installations and operations.

1.3 Target Group

This document is intended for qualified persons and end users. Tasks that do not require any particular qualification can also be performed by end users. Qualified persons must have the following skills:

- ▶ Knowledge of how an inverter works and is operated.
- ▶ Training in how to deal with the dangers and risks associated with installing and using electrical devices and installations.
- ▶ Training in the installation and commissioning of electrical devices and installations.
- ▶ Knowledge of the applicable standards and directives.
- ▶ Knowledge of and compliance with this document and all safety information.

1.4 Safety Instructions

 **WARNING:** This chapter contains important safety and operating instructions.

Read and keep this manual for future reference.

1. Before using the unit, read all instructions and cautionary marking on the unit, the batteries and all appropriate sections of this manual. The company has the right not to quality assurance, if not according to the instructions of this manual for installation and cause equipment damage.
2. All the operation and connection please professional electrical or mechanical engineer.
3. All the electrical installation must comply with the local electrical safety standards.
4. When install PV modules in the daytime, installer should cover the PV modules by opaque materials, otherwise it will be dangerous as high terminal voltage of modules in the sunshine.
5. **CAUTION-**To reduce risk of injury, charge only deep-cycle lead-acid type rechargeable batteries and lithium batteries. Other types of batteries may burst, causing personal injury and damage.
6. Please be clear which kind of battery system you want, lithium battery system or lead-acid battery system, if you choose the wrong system, energy storage system can't work normally.
7. **NEVER** charge a frozen battery.
8. Be very cautious when working with metal tools on or around batteries. A potential risk exists to drop a tool to spark or short circuit batteries or other electrical parts and could cause an explosion.
9. For optimum operation of this inverter, please follow required spec to select appropriate cable size. It's very important to correctly operate this inverter.
10. Please strictly follow installation procedure when you want to disconnect AC or DC terminals. Please refer to INSTALLATION section of this manual for the details.
11. GROUNDING INSTRUCTIONS -This inverter should be connected to a permanent grounded wiring system. Be sure to comply with local requirements and regulation to install this inverter.
12. **NEVER** cause AC output and DC input short circuited. Do NOT connect to the mains when DC input short circuits.
13. Make sure the inverter is completely assembled, before the operation.
14. Do not disassemble the unit. Take it to a qualified service center when service or repair is required. Incorrect re-assembly may result in a risk of electric shock or fire.
15. To reduce risk of electric shock, disconnect all wirings before attempting any maintenance or cleaning. Turning off the unit will not reduce this risk.
16. This is a class A product. In a domestic environment this product may cause radio interference in which case the user may be required to take adequate measures.

2. Product Overview

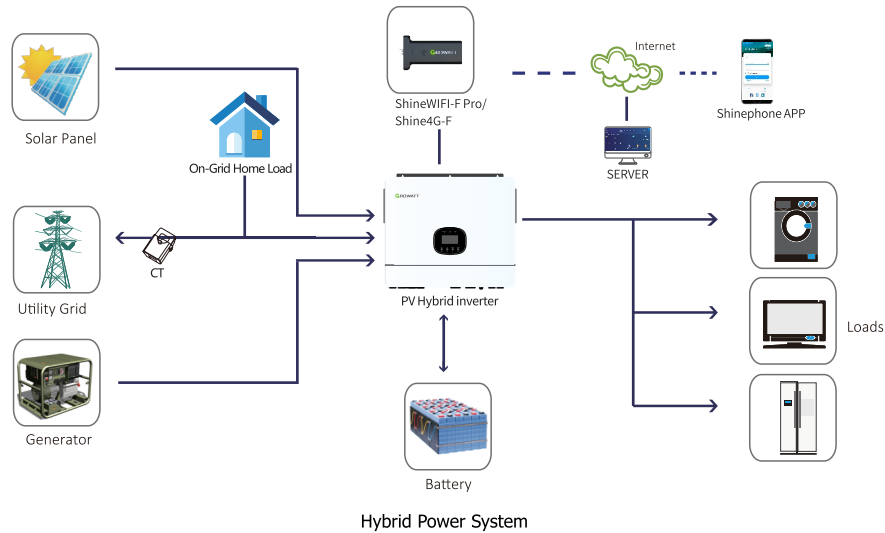

This is a multifunctional PV Hybrid inverter, integrated with a MPPT solar charge controller, a high frequency pure sine wave inverter and a UPS function module in one machine, which is perfect for off grid backup power and self-consumption applications. This inverter can work with or without batteries.

The whole system also need other devices to achieve complete running such as PV modules, generator, or utility grid. Please consult with your system integrator for other possible system architectures depending on your requirements. The WiFi / 4G module is a plug-and-play monitoring device to be installed on the inverter. With this device, users can monitor the status of the PV system from the mobile phone or from the website anytime anywhere.

2.1 Product Features

- ▶ Rated power 8KW to 12KW, power factor 1.
- ▶ 2 strings of MPPT, Max. PV array power 10000watt to 15000watt.
- ▶ MPPT Voltage range 60Vdc-480Vdc, 550Voc.
- ▶ Pure sine wave inverter and MPPT solar charge controller integrated inside.
- ▶ Built-in ATS for automatic grid and generator switching.
- ▶ Able to work with or without battery.
- ▶ With CAN/RS485 for BMS communication.
- ▶ WIFI/4G wireless monitoring(optional).
- ▶ Parallel operation up to 9 unit(only with battery connected).
- ▶ With grid tied function.
- ▶ With dual outputs.
- ▶ With grid peak shaving.
- ▶ With external CT for zero exporting into grid.

2.2 Panel and Port Definitions

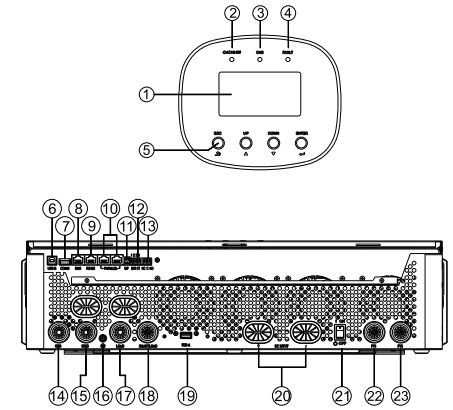
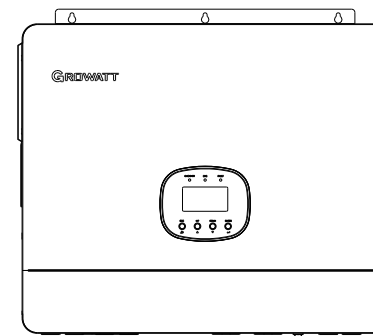

Panel operation	
1. LCD display	2. Status indicator
3. Charging indicator	4. Fault indicator
5. Function buttons	
Communication port	
6. USB communication port	19. WiFi / 4G communication port
8. BMS communication port (support CAN/RS485)	9. RS485 communication port (for expansion)
10. Parallel communication ports	11.DIP
Connection port	
14. Generator input	15. Grid input
16.PE	17. AC output(main)
18. AC output(smart load)	20. Battery input
22. PV1 input	23. PV2 input
Other	
12. EXT CT	13. Dry contact
21. Power on/off switch	

3. Installation Instructions

3.1 Accessory list

Before installation, please inspect the unit. Be sure that nothing inside the package is damaged. You should have received the following items in the package:

Part List			A B C D E F					
Item	Item Name	Qty						
A	The unit	1						
B	Communication cable	1						
C	Parallel communication cable	1						
D	R-type terminal	1						
E	O-type terminal	4						
F	User manual	1						

3.2 Points for attention

Consider the following points before selecting where to install:

Install this inverter at eye level in order to allow the LCD display to be read at all times.

- ▶ The ambient temperature should be between 0°C and 50°C to ensure optimal operation.
- ▶ The recommended installation position is to be adhered to the wall vertically.
- ▶ Do not install in too narrow confined space and pay attention to ventilation.
- ▶ Be sure to keep other objects and surfaces as shown in the right diagram to guarantee sufficient heat dissipation and to have enough space for removing wires.

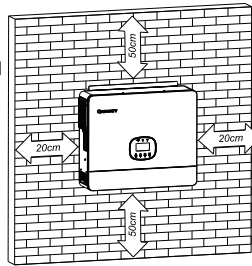

! If the energy storage is installed in areas with salt damage, it will be corroded and may cause fire.

Therefore, do not install it outdoors in areas with salt damage. The areas with salt damage are defined as the areas which are not 500m away from shore or will be affected by sea breezes. The areas affected by the sea breezes vary depending on meteorological conditions (e.g. typhoons, monsoons) or topographical conditions (dams, hills).

! SUITABLE FOR MOUNTING ON CONCRETE OR OTHER NON-COMBUSTIBLE SURFACE ONLY.

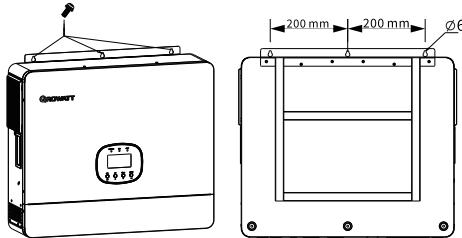

Install the unit by screwing three screws. It's recommended to use M4 or M5 screws.

Preparation for wiring.

Before connecting all wiring, please take off bottom cover by removing four screws as shown below.

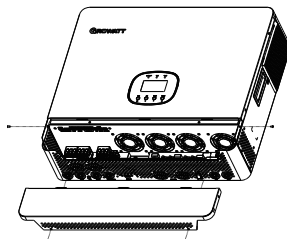

3.3 Battery Connection

! WARNING!

- All wiring must be performed by a qualified person.
- Shock Hazard: Installation must be performed with care due to high battery voltage in series.
- Always disconnect all circuit breakers before making connections to the battery power cable.
- Make sure the battery power cable positive (+) must be connected to battery positive (+), negative (-) must be connected to battery negative (-).
- Do not place anything between the flat part of the inverter terminal and the ring terminal. Otherwise, a short circuit may occur, resulting in overheating and fire.
- Do not apply anti-oxidant substance on the terminals before terminals are connected tightly.

3.3.1 Wiring preparation

1. For safety operation and regulation compliance, it's requested to install a separate DC breaker (over-current protector) or disconnect device between battery and inverter. It may not be requested to have a disconnect device in some applications, however, it's still requested to have DC breaker installed. Please refer to typical amperage in below table as required breaker size.

Recommended DC breaker specification of battery for a single inverter:

Model	1 unit*
SPE 12000 ES	400A / 60VDC
SPE 10000 ES	350A / 60VDC
SPE 8000 ES	300A / 60VDC

2. It's very important for system safety and efficient operation to use appropriate cable for battery connection. To reduce risk of injury, please use the proper recommended cable and terminal size as below.

Recommended battery cable and terminal size:

Model	Wire Size		Torque value
SPE 12000 ES	2 * 2 AWG	33.62mm ²	2-3 Nm
SPE 10000 ES	2 * 2 AWG	33.62mm ²	2-3 Nm
SPE 8000 ES	2 * 3 AWG	26.67mm ²	2-3 Nm

O-type terminal:

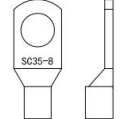

3. Battery Module Selection: Choose the appropriate battery according to the actual situation.

Battery Type	SPE 12000 ES	SPE 10000 ES	SPE 8000 ES
Lead-acid Battery	400Ah capacity battery	300Ah capacity battery	300Ah capacity battery
Lithium Battery	400Ah capacity battery	300Ah capacity battery	300Ah capacity battery

3.3.2 Battery power cable connection

Please follow below steps to implement battery connection:

1. Assemble battery ring terminal based on recommended battery cable and terminal size.
2. Connect all battery packs as units requires.
3. Insert the ring terminal of battery cable flatly into battery connector of inverter and make sure the bolts are tightened with torque of 2Nm. Make sure polarity at both the battery and the inverter/charge is correctly connected and ring terminals are tightly screwed to the battery terminals.

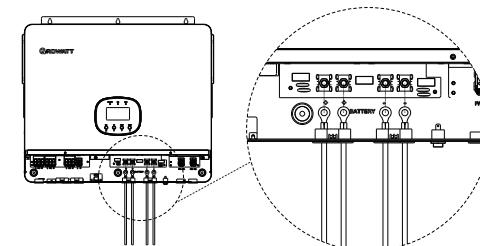

3.3.3 Lithium battery communication cable connection

If used with lithium batteries, make sure to connect the BMS communication cable between the battery and the inverter. It is recommended to use lithium batteries that have been tested with our configuration.

Please follow below steps to implement BMS communication cable connection:

1. Connect one end of the battery's communication cable to the inverter's BMS communication port (below left), which supports RS485 or CAN protocols.

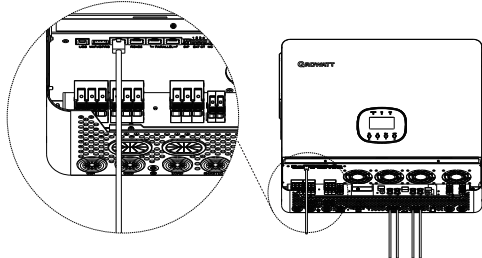

2. The other end of the battery communication cable plugs into the battery communication port (RS485 or CAN).

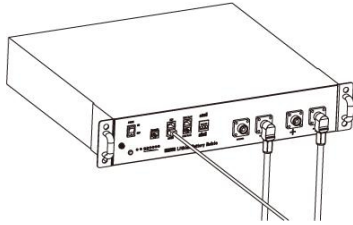

3. The inverter BMS port pin and RS485 port pin assignment shown as below:

Pin number	BMS port	RS485 port (for expansion)
1	RS485B	RS485B
2	RS485A	RS485A
3	--	--
4	CANH	--
5	CANL	--
6	--	--
7	--	--
8	--	--

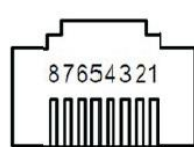

Note: The RS485 port (for expansion) is used for communication expansion and connection to external devices.

Note: In order to ensure the normal communication of lithium battery BMS, please set the battery type as "Li" in program 5, and then LCD will automatically switch to program 36 to select the communication protocol. You can Choose RS485 communication protocol which is from L01 to L50, and you can also choose CAN Communication protocol which is from L51 to L99. (About the specific protocol address of the inverter, please consult the dealer or manufacturer to choose which communication protocol to match the BMS).

3.4 AC Connection



WARNING!

- All wiring must be performed by a qualified personnel.
- Shock Hazard: Be sure that AC power source is disconnected before attempting to wire it to the unit.
- Always disconnect all circuit breakers before making Grid/ GEN/ AC output connection.
- Be sure to connect AC wires with correct polarity. If L and N wires are connected reversely, it may cause utility short-circuited when these inverters are worked in parallel operation.
- There are four terminal blocks with "Grid", "GEN" and "Load" and "Smart Load" markings. Please do not mistakenly connect the input and output connectors.
- Appliances such as air conditioner are required at least 2~3 minutes to restart because it's required to have enough time to balance refrigerant gas inside of circuits. If a power shortage occurs and recovers in a short time, it will cause damage to your connected appliances. To prevent this kind of damage, please check with manufacturer of air conditioner that if it's equipped with time-delay function before installation. Otherwise, this off grid solar inverter will trig overload fault and cut off output to protect your appliance but sometimes it still causes internal damage to the air conditioner.

3.4.1 Connection preparation

1. Before connecting to AC input power source, please install a separate AC breaker between inverter and Grid power source. This will ensure the inverter can be securely disconnected during maintenance and fully protected from over current of Grid. Please refer to typical amperage in below table as required breaker size.

Recommended breaker specification of Grid for a single inverter:

Model	1 unit*
SPE 12000 ES	70A / 230VAC
SPE 10000 ES	70A / 230VAC
SPE 8000 ES	70A / 230VAC

2. It is very important for system safety and efficient operation to use appropriate cable for Grid connection , GEN connection, Load connection and Smart Load connection. To reduce risk of injury, please use the proper recommended cable size as below.

Recommended AC wires size:

Model	AC Input Wire Size		AC Output Wire Size		Torque value
SPE 12000 ES	1 * 6 AWG	13.3mm ²	1 * 6 AWG	13.3mm ²	1.2-1.6 Nm
SPE 10000 ES	1 * 6 AWG	13.3mm ²	1 * 7 AWG	10.55mm ²	1.2-1.6 Nm
SPE 8000 ES	1 * 6 AWG	13.3mm ²	1 * 8 AWG	8.37mm ²	1.2-1.6 Nm

3.4.2 Grid/GEN/ Load/ Smart Load wires Connection :

Please follow the steps below to make Load/ Smart Load /Grid/GEN connections:

1. Remove the insulation covers of the seven wires.
2. Connect the PE protection line first, and then lock in the Load, Smart Load line, Grid line, and GEN line in order.
3. Corresponding polarity positions marked on the terminals.

Please refer to the following:

⊕ → Ground (yellow- green) L → LINE (brown or black) N → Neutral (blue)

1. Insert first Load wires according to polarities indicated on terminal block and ensure that the buckle presses the wire tightly.

L → LINE (brown or black)

N → Neutral (blue)

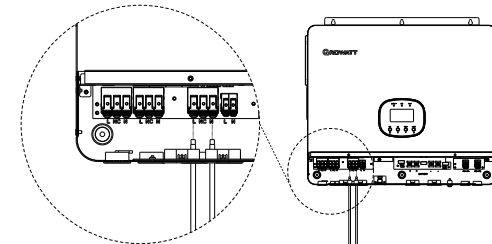

2.Insert Smart Load wires according to polarities indicated on terminal block and ensure that the buckle presses the wire tightly.

L→ **LINE (brown or black)**
N→ **Neutral (blue)**

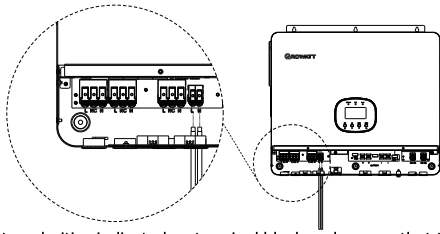

3.Insert Grid wires according to polarities indicated on terminal block and ensure that the buckle presses the wire tightly.

L→ **LINE (brown or black)**
N→ **Neutral (blue)**

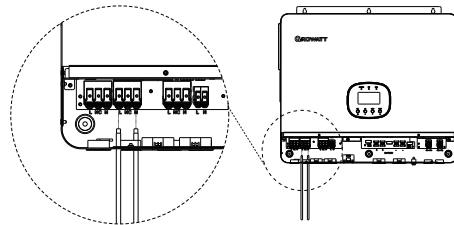

4.Insert GEN wires according to polarities indicated on terminal block and ensure that the buckle presses the wire tightly.

L→ **LINE (brown or black)**
N→ **Neutral (blue)**

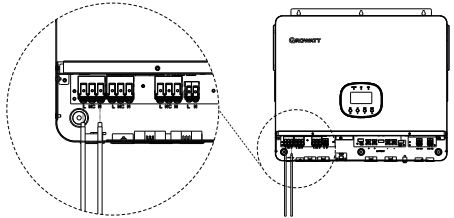

5.Make sure the inverter metal housing is grounded (Ground in the grid system).

⊕→ **Ground (yellow- green)**

R-type terminal:

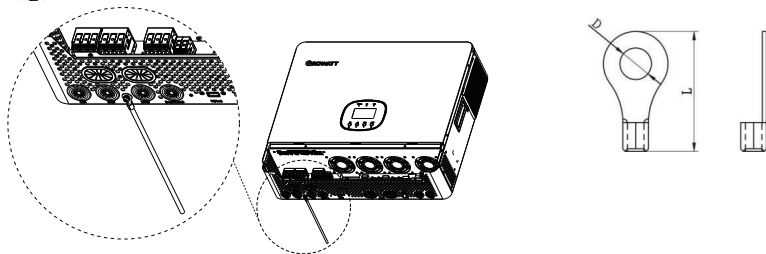

Precautions:

- 1) Before performing the above operations, please ensure that your operating environment is: Non-energized environment.
- 2) After inserting the wire according to the polarity marked on the terminal, don't forget to check that the screw is tightened or the buckle presses the wire tightly.
- 3) After you complete all wiring, please check again to confirm whether the corresponding wires are connected in the correct position to avoid misoperation that may cause the inverter to fail to work properly or damage your equipment. These details that cannot be ignored ensure a good user experience to a certain extent.

3.5 PV Connection

⚠ WARNING!

- All wiring must be performed by a qualified personnel.
- Shock Hazard: Operation with power on is strictly prohibited.
- Before connecting the PV input, be sure to turn off all circuit breakers and confirm that the machine is powered off.
- Be sure to connect PV cable with correct polarity.

3.5.1 Connection preparation

1. Before connecting to PV modules, please install separately a DC circuit breaker between inverter and PV modules.

Recommended breaker specification of PV input for a single inverter:

Model	1 unit*
SPE 12000 ES	27A / 550Vdc
SPE 10000 ES	27A / 550Vdc
SPE 8000 ES	27A / 550Vdc

2.It' very important for system safety and efficient operation to use appropriate cable for PV module connection. To reduce risk of injury, please use the proper recommended cable size as below

Model	Wire Size	Torque value
SPE 12000 ES	1 * 9 AWG 8.4mm ²	1.2-1.6 Nm
SPE 10000 ES	1 * 9 AWG 8.4mm ²	1.2-1.6 Nm
SPE 8000 ES	1 * 9 AWG 8.4mm ²	1.2-1.6 Nm

3. PV Module Selection:

When selecting proper PV modules, please be sure to consider below parameters:

- 1.Open circuit Voltage (Voc) of PV modules not exceeds max. PV array open circuit voltage of inverter. Exceeding the limit will cause damage to the inverter.
- 2.Open circuit Voltage (Voc) of PV modules should be higher than start-up voltage. Lower than will lead to insufficient photovoltaic.

INVERTER MODEL	SPE 12000 ES	SPE 10000 ES	SPE 8000 ES
Max. PV Array Open Circuit Voltage	550Vdc		
Start-up Voltage	120Vdc		
PV Array MPPT Voltage Range	60Vdc~480Vdc (Recommend 380 Vdc)		
Quantity Of PV Panels	Recommend 2~11 photovoltaic panels		

3.5.2 PV cable Connection:

Please follow below steps to implement PV module connection:

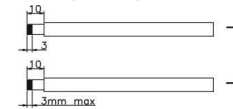

- 1.Remove insulation sleeve 10 mm for positive and negative conductors.
2. then connect positive pole (+) of connection cable to positive pole (+) of PV input connector, connect negative pole (-) of connection cable to negative pole (-) of PV input connector.

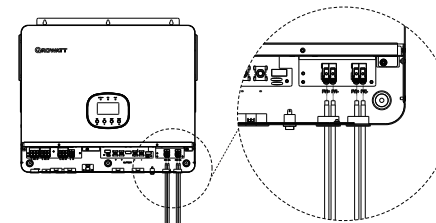

3.6 Communication Connection

Please use supplied communication cable to connect to inverter and PC. Follow on-screen instruction to install the monitoring software. For the detailed software operation, please check user manual of software. The monitoring software is downloadable from our website www.ginverter.com.

3.7 Dry Contact Signal

There is one dry contact(3A/250VAC) available on the rear panel. Dry contacts are used to connect generators. As shown in the table below. When the inverter meets the conditions on the left, it will perform the function on the right. It could be used to deliver signal to external device When the following conditions are met.

Unit Status	Condition	Dry contact port:		
		NC & C	NO & C	
If program 24 is set to automatic				
Power Off	Unit is off and no output is powered	Close	Open	
Power On	Output is powered from Utility	Close	Open	
	Output is powered from Battery or Solar	Program 01 set as Utility first Battery voltage (SOC) < Low DC warning voltage(SOC)	Open	Close
		Battery voltage(SOC) > Setting value in Program 13 or battery charging reaches floating stage	Close	Open
	Program 01 is set as SBU or Solar first	Battery voltage (SOC) < Setting value in Program 12	Open	Close
Battery voltage (SOC) > Setting value in Program 13 or battery charging reaches floating stage		Close	Open	
If program 24 is set to enable				
Power On	Output is powered from Battery or Solar	The dry contact always sends a power-on signal.	Open	Close
If program 24 is set to disable				
Power On	Output is powered from Battery or Solar	The dry contact always sends a power-off signal.	Close	Open

3.8 CT Connection

CT is an optional accessory that needs to be purchased separately. Currently, the available optional CT specifications are as follows:

Part number	CT specification	Recommender system	Property
013.SK0000500	100A-50mA / 2000:1 / 4m	Single system or 3 Pcs three-phase parallel system	South African single camera standard
013.SK0002500	100A-50mA / 2000:1 / 10m	Single system or 3 Pcs three-phase parallel system	North American single camera standard
013.SK0002800	250A-62.5mA / 4000:1 / 10m	2-3 Pcs Single phase parallel or 6 Pcs three-phase parallel system	Additional purchase
013.SK0002900	500A-66.7mA / 7500:1 / 10m	4-6 Pcs Single phase parallel	Additional purchase

The specific installation method is as follows.

Note: The L line passes through the CT, and the arrow on the CT indicates the current direction points to the inverter.

Connect the two signal wires coming out of the CT to the terminal marked EXT CT :

White line→ No. 1 Signal Terminal (CT-L-I+)

Black line→ No. 2 Signal Terminal (CT-L-I-)

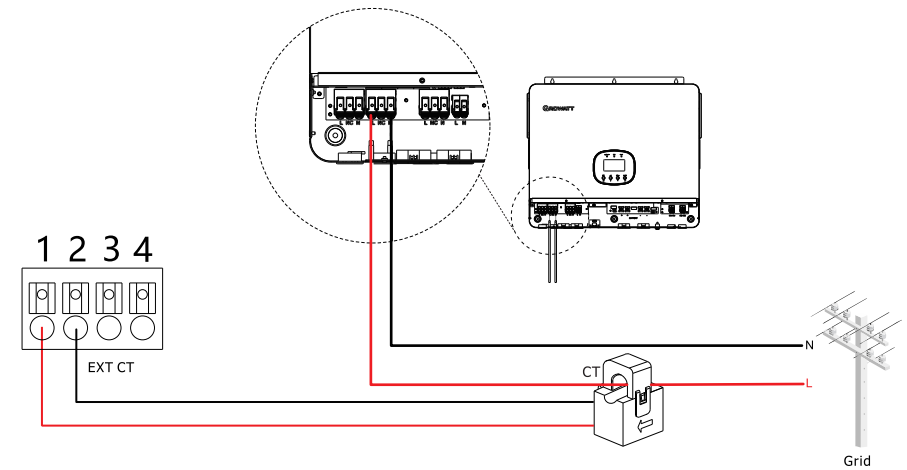

Final Assembly

Double check that all wiring is correct. Please put bottom cover back by screwing four screws as shown below.

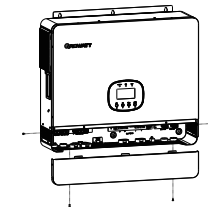

3.9 Wiring system for inverter

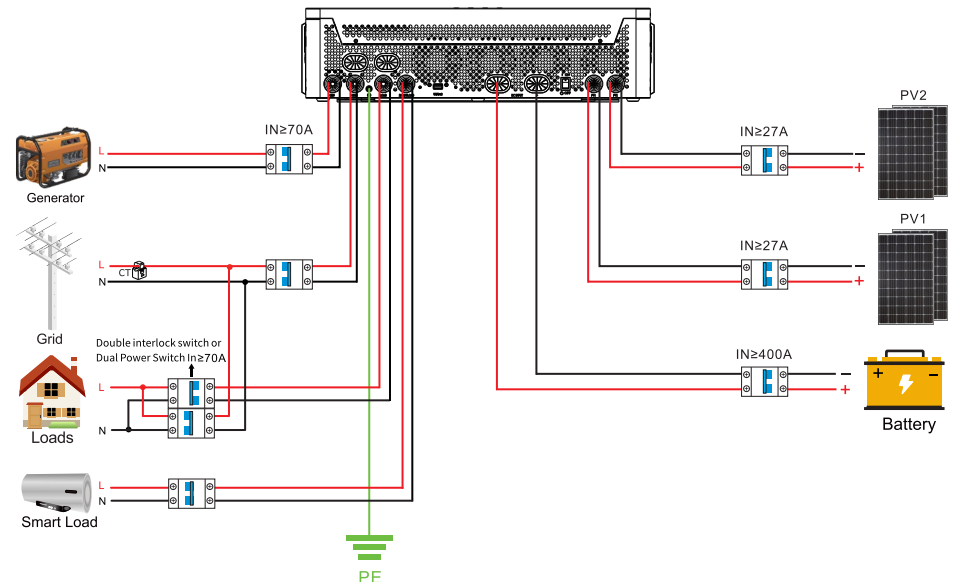

4. Operation

4.1 Power ON/OFF

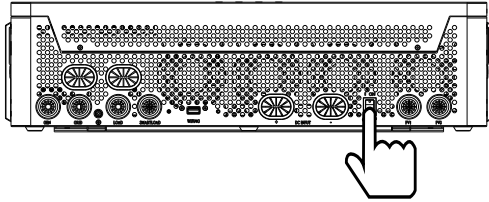

After correct installation, switch on the battery switch, switch on the inverter switch, wait about 30 seconds, inverter output.

4.2 Display Panel Introduction

The operation and display panel, shown in below chart, is on the front panel of the inverter. It includes three indicators, four function keys and a LCD display, indicating the operating status and input/output power information.

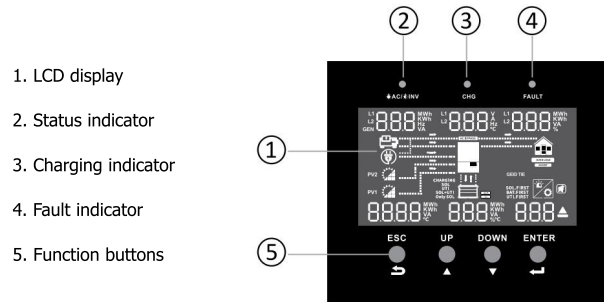

LED Indicator

LED Indicator	Messages		
AC / INV	Green	Solid On	Output is powered by utility in Line mode.
		Flashing	Output is powered by battery or PV in battery mode.
CHG	Green	Solid On	Battery is fully charged.
		Flashing	Battery is charging.
FAULT	Red	Solid On	Fault occurs in the inverter.
		Flashing	Warning condition occurs in the inverter.

Function Buttons

Button	Description
ESC	To exit setting mode
UP	To go to previous selection
DOWN	To go to next selection
ENTER	To confirm the selection in setting mode or enter setting mode

4.2.1 LCD Display Icons

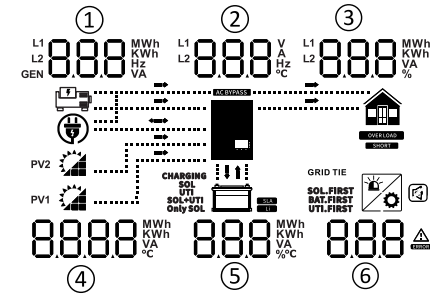

Icon	Description
AC Input Information	
	Grid icon
	Generator icon
①	Indicate AC input power, AC input voltage, AC input frequency, AC input current
AC BYPASS	Indicate AC power loads in bypass
PV Input Information	
PV1 PV2	Left: PV1 input icon Right: PV2 input icon
④	Indicate PV power, PV voltage, PV current, etc
Output Information	
	Inverter icon
②	Indicate output voltage, output current, output frequency, inverter temperature
Load Information	
	Load icon
③	Indicate power of load, power percentage of load
OVERLOAD	Indicate overload happened
SHORT	Indicate short circuit happened
Battery Information	
	Indicate battery level by 0-24%, 25-49%, 50-74% and 75-100% in battery mode and charging status in line mode.
⑤	Indicate battery voltage, battery percentage, battery current
SLA	Indicate SLA battery
Li	Indicate lithium battery
CHARGING SOL SOL+UTI Only SOL	Indicate charging source priority: solar first, solar and utility, or only solar
Other Information	
SOL-FIRST BAT-FIRST UTI-FIRST	Indicate output source priority: solar first, utility first, SBU mode or SUB mode
⑥	Indicate warning code or fault code
	Indicate a warning or a fault is happening
	Indicate it's during setting values
	Indicate the alarm is disabled

In battery charge mode, battery icon will present Battery Charging Status		
Status	Battery voltage	LCD Display
Constant Current mode / Constant Voltage mode	<48V	4 bars will flash in turns.
	48 ~ 50V	Bottom bar will be on and the other three bars will flash in turns.
	50 ~ 52V	Bottom two bars will be on and the other two bars will flash in turns.
	> 52V	Bottom three bars will be on and the top bar will flash.
Floating mode. Batteries are fully charged.		4 bars will be on.

In battery discharge mode, battery icon will present Battery Capacity		
Load Percentage	Battery Voltage	LCD Display
Load >50%	< 41.2V	
	41.2~43.2V	
	43.2~45.2V	
50%> Load > 20%	> 45.2V	
	< 43.6V	
	43.6~46V	
Load < 20%	> 47.6V	
	< 44.8V	
	44.8~46.8V	
	46.8~48.8V	
	> 48.8	

4.2.2 Display Information

The LCD display information will be switched in turns by pressing "UP" or "DOWN" key. The selectable information is switched as below order: voltage, frequency, current, power, temperature, energy, firmware version.

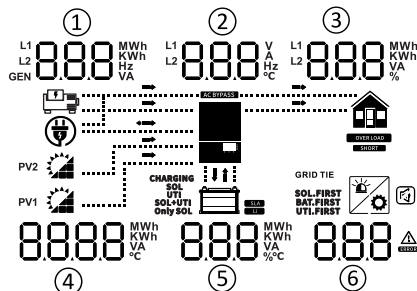

Setting Information	LCD display	
<ol style="list-style-type: none"> AC Input voltage (grid input) Output voltage Load percentage Left: PV1 input voltage Right: PV2 input voltage Battery voltage Warning or Fault code *Default Display Screen		
<ol style="list-style-type: none"> AC Input voltage (generator input) (If the AC input is only generator input, it means that what is displayed at this time is the input voltage of the generator. The current, power and frequency displayed after turning the page are also the input parameters of the generator, which will not be explained below.) Output voltage Load percentage Left: PV1 input voltage Right: PV2 input voltage Battery voltage Warning or Fault code 		
<ol style="list-style-type: none"> AC Input frequency Output frequency Load power PV energy sum Battery percentage Warning or Fault code 		/
<ol style="list-style-type: none"> AC Input current Output current Load percentage Left: PV1 input current Right: PV2 input current Battery charging current Warning or Fault code 		
<ol style="list-style-type: none"> Feed to Grid current Output current Load percentage Left: PV1 input current Right: PV2 input current Battery charging current Warning or Fault code 		
<ol style="list-style-type: none"> AC input power Output voltage Load power Left: PV1 input power Right: PV2 input power Battery charging power Warning or Fault code 		

<ul style="list-style-type: none"> ① Feed to Grid power ② Output voltage ③ Load power ④ Left: PV1 input power Right: PV2 input power ⑤ Battery charging power ⑥ Warning or Fault code 		
<ul style="list-style-type: none"> ① CT power ② CT active Power screen ③ Loads and home load power ④ Left: PV1 input power Right: PV2 input power ⑤ Battery charging power ⑥ Warning or Fault code 		
<ul style="list-style-type: none"> ① CT power ② CT active Power screen ③ Load power ④ Left: PV1 temperature Right: PV2 temperature ⑤ Left: Ilc temperature Right: Battery temperature ⑥ Warning or Fault code 		
<ul style="list-style-type: none"> ① AC input power ② Inverter temperature ③ Load power ④ Left: PV1 temperature Right: PV2 temperature ⑤ Left: Ilc temperature Right: Battery temperature ⑥ Warning or Fault code 		
<ul style="list-style-type: none"> ① Left: Today's energy feed to grid Right: Total energy feed to grid ② Output frequency ③ Left: Today's load energy Right: Total load energy ④ Left: Today's PV energy Right: Total PV energy ⑤ Left: Today's battery discharge energy Right: Total battery discharge energy ⑥ Indicate today's energy or total energy. 		
Firmware version (CPU1: 141-00-527; CPU2:142-00-529; CPU3:143-00-528)		
Time (13:54:29, May 29, 2024)		

4.2.3 Operating Mode Description

Operation mode	Description	LCD display	
Standby mode /Power saving mode Note: *Standby mode: The inverter is not turned on yet but at this time, the inverter can charge battery without AC output. *Power saving mode: If enabled, the output of inverter will be off when connected load is pretty low or not detected.	No output is supplied by the unit but it still can charge batteries.	Charging by PV energy 	No charging
Fault mode Note: *Fault mode: Errors are caused by inside circuit error or external reasons such as over temperature, output short circuited and so on.	PV energy can charge batteries.	Charging by PV energy 	No charging
Line Mode	The unit will provide output power from the mains. It can also charge the battery at line mode.	Charging by PV energy 	Charging by utility
		No battery connected 	
Feeds grid Mode	Solar feeds to the grid or battery feeds to the grid	PV energy charges battery, PV energy provides power to the load and feeds remaining energy to the grid. 	Battery energy provides power to the load and feeds remaining energy to the grid.
Battery Mode	The unit will provide output power from battery and PV power.	Power from battery and PV energy 	Power from battery only







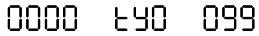
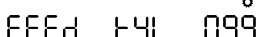
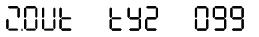

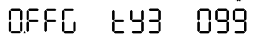
4.3 LCD parameter setting



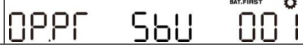

4.3.1 General settings

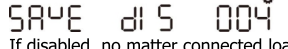
After pressing and holding ENTER button for 3 seconds, the unit will enter setting mode. Press "UP" or "DOWN" button to select setting programs. Then press "ENTER" button to confirm the selection or ESC button to exit.

Program	Description	Setting Option																												
99	Quick Settings * After setting TY1, TY2, or TY3, the initial default values of some settings will be changed. Users can set them based on actual usage, which can help users quickly set the inverter settings	TY0: User-defined settings(default)  This shortcut setting item indicates that all of the following setting items are initial default values, and users need to change the setting items according to actual needs.																												
		TY1: On Grid Mode  Change the default values of the following settings as follows: <table border="1" data-bbox="415 511 1006 641"> <thead> <tr> <th>Program</th> <th>01</th> <th>03</th> <th>14</th> <th>55</th> <th>67</th> <th>68</th> </tr> </thead> <tbody> <tr> <td>Value</td> <td>SUB</td> <td>UPS</td> <td>SNU</td> <td>BLU</td> <td>ENA</td> <td>SAF</td> </tr> <tr> <th>Program</th> <th>69</th> <th>71</th> <th>76</th> <th>78</th> <th>79</th> <th>80</th> </tr> <tr> <td>Value</td> <td>12KW</td> <td>DIS</td> <td>DIS</td> <td>0</td> <td>DIS</td> <td>24KW</td> </tr> </tbody> </table> The values of these settings represent a brief description: Solar energy can be fed into the power grid, default is the certification standard of the South African power grid, and the maximum power fed into the power grid is 12KW. The specific priorities are as follows: <p>1. Load priority setting: When there is solar energy: solar energy is prioritized to supply power to the loads, and excess power is charged to the battery; when there is insufficient solar energy, solar energy and utility supply power to the loads together; when there is insufficient solar energy and no utility, the battery will discharge. When there is no solar energy, utility prioritizes supplying power to the load. When utility is not available, the battery only supplies power to the loads.</p> <p>2. Charging priority setting: solar energy and utility jointly charge the battery, and utility charging time is executed according to the program 75 setting time.</p> <p>3. Solar priority setting: BLU (default): Solar energy prioritizes charging the battery, excess energy is used to power the load, and finally the remaining energy is fed to the grid. LBU: Solar energy is prioritized to power the load, excess energy is charged to the battery, and finally the remaining energy is fed to the grid. LUB: Solar energy is prioritized to power the load, excess energy is fed to the grid, and finally there is surplus energy to charge the battery.</p> <p>4. Battery energy priority: The battery can be discharged only when there is no utility.</p>	Program	01	03	14	55	67	68	Value	SUB	UPS	SNU	BLU	ENA	SAF	Program	69	71	76	78	79	80	Value	12KW	DIS	DIS	0	DIS	24KW
		Program	01	03	14	55	67	68																						
		Value	SUB	UPS	SNU	BLU	ENA	SAF																						
		Program	69	71	76	78	79	80																						
		Value	12KW	DIS	DIS	0	DIS	24KW																						
		TY2: Zero Export Limit Mode  Change the default values of the following settings as follows: <table border="1" data-bbox="415 1404 1006 1534"> <thead> <tr> <th>Program</th> <th>01</th> <th>03</th> <th>14</th> <th>55</th> <th>67</th> <th>68</th> </tr> </thead> <tbody> <tr> <td>Value</td> <td>SUB</td> <td>UPS</td> <td>SNU</td> <td>LUB</td> <td>ENA</td> <td>SAF</td> </tr> <tr> <th>Program</th> <th>69</th> <th>71</th> <th>76</th> <th>78</th> <th>79</th> <th>80</th> </tr> <tr> <td>Value</td> <td>12KW</td> <td>ENA</td> <td>EAN</td> <td>0</td> <td>DIS</td> <td>24KW</td> </tr> </tbody> </table>	Program	01	03	14	55	67	68	Value	SUB	UPS	SNU	LUB	ENA	SAF	Program	69	71	76	78	79	80	Value	12KW	ENA	EAN	0	DIS	24KW
		Program	01	03	14	55	67	68																						
		Value	SUB	UPS	SNU	LUB	ENA	SAF																						
		Program	69	71	76	78	79	80																						
Value	12KW	ENA	EAN	0	DIS	24KW																								

		The values of these settings represent a brief description: Solar and battery energy can be fed into the power grid, default is the certification standard of the South African power grid, and the maximum power fed into the power grid is 12KW. At the same time, the anti-backflow power is 0KW. The specific priorities are as follows: <p>1. Load priority setting: When there is solar energy: when there is sufficient solar energy, the solar energy is prioritized to supply power to the load, and then fed into the grid, and the excess is used to charge the battery; when there is insufficient photovoltaic energy, during the battery feeding time (Program 74), the solar energy and the battery supply power to the load and the grid together; when not during the battery feeding time (Program 74), the solar energy and utility supply power to the load together. When there is no solar energy: during the battery feeding time (program 74), the battery supplies power to the load and feeds the grid; outside the battery feeding time (program 74), utility supplies power to the load.</p> <p>2. Charging priority setting: When there is solar energy, the solar energy charges the battery with excess energy after loading and feeding the grid; when there is no solar energy, utility sets the charging time according to program 75.</p> <p>3. Solar priority setting: BLU: Solar energy prioritizes charging the battery, excess energy is used to power the load, and finally the remaining energy is fed to the grid. LBU: Solar energy is prioritized to power the load, excess energy is charged to the battery, and finally the remaining energy is fed to the grid. LUB (default): Solar energy is prioritized to power the load, excess energy is fed to the grid, and finally there is surplus energy to charge the battery.</p> <p>4. Battery energy priority: When there is sufficient solar energy, the excess solar energy charges the battery. When the solar energy is insufficient, the battery is allowed to discharge during the feeding period according to program 74.</p>																												
		TY3: Off Grid Mode  Change the default values of the following settings as follows: <table border="1" data-bbox="1493 1055 2083 1185"> <thead> <tr> <th>Program</th> <th>01</th> <th>03</th> <th>14</th> <th>55</th> <th>67</th> <th>68</th> </tr> </thead> <tbody> <tr> <td>Value</td> <td>UTI</td> <td>APL</td> <td>CSO</td> <td>BLU</td> <td>DIS</td> <td>SAF</td> </tr> <tr> <th>Program</th> <th>69</th> <th>71</th> <th>76</th> <th>78</th> <th>79</th> <th>80</th> </tr> <tr> <td>Value</td> <td>12KW</td> <td>DIS</td> <td>DIS</td> <td>0</td> <td>DIS</td> <td>24KW</td> </tr> </tbody> </table> The values of these settings represent a brief description: Grid connection is not enabled, enter off grid mode. The specific priorities are as follows: <p>1. Load priority setting: When there is utility: during the output time of program 50, utility bypasses to supply power to the load; outside the output time of utility, the battery and photovoltaic supply power to the load. When there is no utility: battery and solar energy provide power to the load.</p> <p>2. Charging priority setting: Prioritize solar energy to charge the battery. When there is solar energy, solar energy charges the battery. When there is no solar energy, utility charges the battery during the program 50 grid output time and the program 49 utility charging time.</p>	Program	01	03	14	55	67	68	Value	UTI	APL	CSO	BLU	DIS	SAF	Program	69	71	76	78	79	80	Value	12KW	DIS	DIS	0	DIS	24KW
Program	01	03	14	55	67	68																								
Value	UTI	APL	CSO	BLU	DIS	SAF																								
Program	69	71	76	78	79	80																								
Value	12KW	DIS	DIS	0	DIS	24KW																								

01	Output source priority: To configure load power source priority. (After program 67 are enabled, this program is fixed SUB and cannot be set.)	Solar first 	Solar energy provides power to the loads as first priority. If solar energy is not sufficient to power all connected loads, battery energy will supply power the loads at the same time. Utility provides power to the loads only when any one condition happens: - Solar energy is not available - Battery voltage drops to either low-level warning voltage or the setting point in program 12.
		Utility first 	Utility will provide power to the loads as first priority. Solar and battery energy will provide power to the loads only when utility power is not available.
		SBU priority 	Solar energy provides power to the loads as first priority. If solar energy is not sufficient to power all connected loads, battery will supply power to the loads at the same time. Utility provides power to the loads only when battery voltage drops to either low-level warning voltage or the setting point in program 12.
		SUB priority(default) 	Solar energy provides power to the loads as first priority. If solar energy is not sufficient to power all connected loads, solar and utility will power loads at the same time. Battery provides power to the loads only when solar energy is not sufficient and there is no utility.
02	Maximum charging current: set total charging current for solar and utility chargers.		SPE 12000 ES: Default 120A, 0A~250A Settable. SPE 10000 ES: Default 120A, 0A~220A Settable. SPE 8000 ES: Default 120A, 0A~190A Settable. (Max. charging current = utility charging current + solar charging current) (If LI is selected in Program 5, this program can't be set up)
03	AC input voltage range (After program 67 are enabled, this program is fixed UPS and cannot be set).	Appliance (default) 	If selected, acceptable AC input voltage range will be within: 90~280VAC
		UPS 	If selected, acceptable AC input voltage range will be within: 170~280VAC
04	Power saving mode enable/disable	Saving mode disable (default) 	If disabled, no matter connected load is low or high, the on/off status of inverter output will not be effected.
		Saving mode enable 	If enabled, the output of inverter will be off when connected load is pretty low or not detected.

05	Battery type	AGM (default)—Suitable for lead-acid battery 	<table border="1"> <tr> <td>Items that cannot be set</td> <td>19</td> <td>20</td> <td>21</td> </tr> <tr> <td>default</td> <td>56.4V</td> <td>54V</td> <td>42V</td> </tr> </table>	Items that cannot be set	19	20	21	default	56.4V	54V	42V																							
		Items that cannot be set	19	20	21																													
		default	56.4V	54V	42V																													
		<table border="1"> <thead> <tr> <th>Items that can be set:</th> <th>default</th> <th>Set range</th> <th>Set requirements</th> </tr> </thead> <tbody> <tr> <td>02</td> <td>120A</td> <td>0A~250A</td> <td></td> </tr> <tr> <td>11</td> <td>60A</td> <td>0A~250A</td> <td></td> </tr> <tr> <td>12</td> <td>46V</td> <td>44~51.2V</td> <td><13 setting value</td> </tr> <tr> <td>13</td> <td>54v</td> <td>48~58.0V</td> <td></td> </tr> </tbody> </table>	Items that can be set:	default	Set range	Set requirements	02	120A	0A~250A		11	60A	0A~250A		12	46V	44~51.2V	<13 setting value	13	54v	48~58.0V													
		Items that can be set:	default	Set range	Set requirements																													
		02	120A	0A~250A																														
		11	60A	0A~250A																														
		12	46V	44~51.2V	<13 setting value																													
		13	54v	48~58.0V																														
		Flooded—Suitable for lead-acid battery or flood battery 	<table border="1"> <tr> <td>Items that cannot be set:</td> <td>19</td> <td>20</td> <td>21</td> </tr> <tr> <td>default</td> <td>58.4V</td> <td>56V</td> <td>42V</td> </tr> </table>	Items that cannot be set:	19	20	21	default	58.4V	56V	42V																							
Items that cannot be set:	19	20	21																															
default	58.4V	56V	42V																															
<table border="1"> <thead> <tr> <th>Items that can be set:</th> <th>default</th> <th>Set range</th> <th>Set requirements</th> </tr> </thead> <tbody> <tr> <td>02</td> <td>120A</td> <td>0A~250A</td> <td></td> </tr> <tr> <td>11</td> <td>60A</td> <td>0A~250A</td> <td></td> </tr> <tr> <td>12</td> <td>48V</td> <td>44~51.2V</td> <td><13 setting value</td> </tr> <tr> <td>13</td> <td>56v</td> <td>48~58.0V</td> <td></td> </tr> </tbody> </table>	Items that can be set:	default	Set range	Set requirements	02	120A	0A~250A		11	60A	0A~250A		12	48V	44~51.2V	<13 setting value	13	56v	48~58.0V															
Items that can be set:	default	Set range	Set requirements																															
02	120A	0A~250A																																
11	60A	0A~250A																																
12	48V	44~51.2V	<13 setting value																															
13	56v	48~58.0V																																
Lithium (only suitable when communicated with BMS communication) 	<table border="1"> <tr> <td>Items that cannot be set:</td> <td>02</td> <td>19</td> <td>20</td> </tr> </table>	Items that cannot be set:	02	19	20																													
Items that cannot be set:	02	19	20																															
<table border="1"> <thead> <tr> <th>Items that can be set:</th> <th>default</th> <th>Set range</th> <th>Set requirements</th> </tr> </thead> <tbody> <tr> <td>11</td> <td>20A</td> <td>0A~250A</td> <td></td> </tr> <tr> <td>12</td> <td>50%</td> <td>10%~95%</td> <td><13 setting value</td> </tr> <tr> <td>13</td> <td>95%</td> <td>15%~100%</td> <td></td> </tr> <tr> <td>21</td> <td>20%</td> <td>5%~50%</td> <td><12 setting value</td> </tr> </tbody> </table>	Items that can be set:	default	Set range	Set requirements	11	20A	0A~250A		12	50%	10%~95%	<13 setting value	13	95%	15%~100%		21	20%	5%~50%	<12 setting value														
Items that can be set:	default	Set range	Set requirements																															
11	20A	0A~250A																																
12	50%	10%~95%	<13 setting value																															
13	95%	15%~100%																																
21	20%	5%~50%	<12 setting value																															
User-Defined—Suitable for lead-acid battery, battery parameters can be set manually 	<table border="1"> <tr> <td>Items that can be set:</td> <td>default</td> <td>Set range</td> <td>Set requirements</td> </tr> <tr> <td>02</td> <td>120A</td> <td>0A~250A</td> <td></td> </tr> <tr> <td>11</td> <td>60A</td> <td>0A~250A</td> <td></td> </tr> <tr> <td>12</td> <td>46V</td> <td>44~51.2V</td> <td><13 setting value</td> </tr> <tr> <td>13</td> <td>54V</td> <td>48~58.0V</td> <td></td> </tr> <tr> <td>19</td> <td>56.4V</td> <td>48~58.4V</td> <td></td> </tr> <tr> <td>20</td> <td>54V</td> <td>48~58.4V</td> <td></td> </tr> <tr> <td>21</td> <td>42V</td> <td>40~48V</td> <td><12 setting value</td> </tr> </table>	Items that can be set:	default	Set range	Set requirements	02	120A	0A~250A		11	60A	0A~250A		12	46V	44~51.2V	<13 setting value	13	54V	48~58.0V		19	56.4V	48~58.4V		20	54V	48~58.4V		21	42V	40~48V	<12 setting value	
Items that can be set:	default	Set range	Set requirements																															
02	120A	0A~250A																																
11	60A	0A~250A																																
12	46V	44~51.2V	<13 setting value																															
13	54V	48~58.0V																																
19	56.4V	48~58.4V																																
20	54V	48~58.4V																																
21	42V	40~48V	<12 setting value																															
User-Defined 2 (suitable when lithium battery without BMS communication or communication protocol not matched with the inverter, battery parameters can be set manually) 																																		

		Items that can be set:	default	Set range	Set requirements
		02	20A	0A~250A	
		11	20A	0A~250A	
		12	48V	44~51.2V	<13 setting value
		13	52V	48~58.0V	
		19	54V	48~58.4V	
		20	54V	48~58.4V	Suggestion=19 setting value
		21	46V	40~48V	<12 setting value
06	Auto restart when overload occurs	Restart disable (default) LdFS d15 006		Restart enable LdFS ENA 006	
07	Auto restart when over temperature occurs	Restart disable (default) t1FS d15 007		Restart enable t1FS ENA 007	
08	Output voltage	230V (default) OUtV 230 008		220V OUtV 220 008	
		240V OUtV 240 008		208V OUtV 208 008	
09	Output frequency	50Hz (default) OUtF 50 009		60Hz OUtF 60 009	
11	Maximum utility & Generator charging current	ACI 60 ^A GENI 40 ^A 011			SPE 12000 ES: Default 60A/40A, 0A~250A Settable. SPE 10000 ES: Default 60A/40A, 0A~220A Settable. SPE 8000 ES: Default 60A/40A, 0A~190A Settable. Note: If setting value in Program 02 is smaller than that in Program 11, the inverter will apply charging current from Program 02 for utility charger
12	Setting voltage point back to utility source when selecting "SBU priority" or "Solar first" in program 01	b2AC 460 ^V 012			The default value and adjustable range vary in different Battery type, please refer to program 5 for details
13	Setting voltage point back to battery mode when selecting "SBU priority" or "Solar first" in program 01	AC2b 540 ^V 013			The default value and adjustable range vary in different Battery type, please refer to program 5 for details
14	Charger source priority: To configure charger source priority. (After program 67 are enabled, this program is fixed SUN and cannot be set.)	If this off grid solar inverter is working in Line, Standby or Fault mode, charger source can be programmed as below:			
		Solar first CGPF SOL 014		Solar energy will charge battery as first priority. Utility will charge battery only when solar energy is not available.	

		Solar and Utility (default) CGPF SUN 014		Solar energy and utility will both charge battery.
		Only Solar CGPF SOL 014		Solar energy will be the only charger source no matter utility is available or not.
		If this PV Hybrid Inverter is working in Battery mode or Power saving mode, only solar energy can charge battery. Solar energy will charge battery if it's available and sufficient.		
15	Alarm control	Alarm on (default) bU22 ON 015		Alarm off bU22 OFF 015
16	Backlight control	Backlight on (default) LcdB ON 016		Backlight off LcdB OFF 016
17	Beeps while primary source is interrupted	Alarm on (default) ALAN ON 017		Alarm off ALAN OFF 017
18	Overload bypass: When enabled, the unit will transfer to line mode if overload occurs in battery mode.	Bypass disable (default) bYP d15 018		Bypass enable bYP ENA 018
19	C.V. charging voltage.	Cv 564 ^V 019		Default 56.4V, 48.0V~58.4V Settable
20	Floating charging voltage.	FLEv 540 ^V 020		Default 54.0V, 48.0V~58.4V Settable
21	Low DC cut-off voltage.	CUEv 420 ^V 021		The default value and adjustable range vary in different Battery type, please refer to program 5 for details Note: The low voltage alarm point is (program 21) +2V. When this value is reached, the machine reports 04. When reach Low DC cut-off voltage: 1) If battery power is only power source available, inverter will shut down. 2) If PV energy and battery power are available, inverter will charge battery without AC output. 3) If PV energy, battery power and utility are all available, inverter will transfer to line mode and provide output power to loads, and charge the battery at the same time.
23	AC output mode *This setting is only available when the inverter is in standby mode (Switch off). Note: Parallel operation can only work when battery connected	Parallel: PRLL PAR 023		L1 Phase: PRLL 3P1 023
		L2 Phase: PRLL 3P2 023		L3 Phase: PRLL 3P3 023
		When the units are used in parallel with single phase or alone, please select "PAL" in program 23. It requires 3 inverters to support three-phase equipment, 1 inverter in each phase. Please select "3P1" in program 23 for the inverters connected to L1 phase, "3P2" in program 23 for the inverters connected to L2 phase and "3P3" in program 23 for the inverters connected to L3 phase.		

24	Dry Contact Signal * For details, please refer to Chapter 3.7	Automatic (default) dry Ato 024 ^o	The dry contact can intelligently generate a power-on or power-off signal to the generator based on the battery voltage.
		Enable dry ENR 024 ^o	The dry contact always sends a power-on signal.
		Disable dry dis 024 ^o	The dry contacts always send a power-off signals.
28	Address setting (for expansion)	Addr 1 028 ^o Default 1, 1~255 Settable	
36	RS485 Communication protocol	PtCL L01 036 ^o	Protocol 1~50
	CAN Communication protocol	PtCL L51 036 ^o	Protocol 51~99
37	Real time setting---Year	2018 037 ^o	Default 2018, range 2018~2099
38	Real time setting---Month	12 038 ^o	Default 01, range 01~12
39	Real time setting---Date	dry 13 039 ^o	Default 01, range 01~31
40	Real time setting---Hour	hour 13 040 ^o	Default 00, range 00~23
41	Real time setting---Minute	11 50 041 ^o	Default 00, range 00~59
42	Real time setting---Second	SEC 50 042 ^o	Default 00, range 00~59
43	Battery equalization	Battery equalization enable EQ ENR 043 ^o	Battery equalization disable(default) EQ dis 043 ^o
		If "Flooded" or "User-Defined" is selected in program 05, this program can be set up.	
44	Battery equalization voltage	EQV 58.4V 044 ^o Default 58.4V, 48.0V~58.4V Settable	
45	Battery equalized time	11 11	Default 60min, 5min~900min Settable
		EQE 60 045 ^o	
46	Battery equalized timeout	11 11	Default 120min, 5min~900min Settable
		EQTO 120 046 ^o	

47	Equalization interval	dry EQ 30 047 ^o	Default 30days, 1 days~90 days Settable
48	Equalization activated immediately	Equalization activated immediately on EQ ON 048 ^o	Equalization activated immediately off(default) EQ OFF 048 ^o
		If equalization function is enabled in program 43, this program can be setup. If "On" is selected in this program, it's to activate battery equalization immediately and LCD main page will shows "EQ". If "Off" is selected, it will cancel equalization function until next activated equalization time arrives based on program 47setting. At this time, "EQ" will not be shown in LCD main page.	
49	Utility charging time (This program can only be set when program 67 are not enabled)	0000(default) Allow utility to charge the battery all day run. CHG 11 11	The time allows utility to charge the battery. Use 4 digits to represent the time period, the upper two digits represent the time when utility start to charge the battery, setting range from 00 to 23, and the lower two digits represent the time when utility end to charge the battery, setting range from 00 to 23. (eg: 2320 represents the time allows utility to charge the battery is from 23:00 to the next day 20:59, and the utility charging is prohibited outside of this period)
		0000 049 ^o	
50	Utility output time (This program can only be set when program 67 are not enabled)	0000(default) Allow utility to power the load all day run. OUP 11 11	The time allows utility to power the load. Use 4 digits to represent the time period, the upper two digits represent the time when utility start to power the load, setting range from 00 to 23, and the lower two digits represent the time when utility end to power the load, setting range from 00 to 23. (eg: 2320 represents the time allows utility to power the load is from 23:00 to the next day 20:59, and the utility power is prohibited outside of this period)
		0000 050 ^o	
54	Lithium battery strong charging execution cycle time. (If program 05 is set to Li and set to ON, it means that the lithium battery is periodically forced to charge to SOC of 100%. OFF indicates that the function is not enabled)	OFF: Turn off periodic strong charging LI 11 OFF 054 ^o	ON: Turn on periodic strong charging. Default 30days, 1 days~90 days Settable LI 11 ON 054 ^o
		LI 11 030 054 ^o	
55	Setting solar energy supply priority when selecting "SUB priority" in program 01	Charge first (default) SGFD BLU 055 ^o	Solar energy provides power to charge battery as first priority. Solar energy provides power to the loads as second priority. Solar energy provides power to feed to grid as third priority.
		Load first SGFD LBU 055 ^o	Solar energy provides power to the loads as first priority. Solar energy provides power to the charge battery as second priority. Solar energy provides power to feed to grid as third priority.

		Load first SOFd LUb 055	Solar energy provides power to the loads as first priority. Solar energy provides power to feed to grid as second priority. Solar energy provides power to the charge battery as third priority (This program can only be set when program 67 are enabled)
56	NG relay enable setting	NG relay enable(default) NGRY ENA 056 NG relay disable NGRY dIS 056	Grounding in inverter operation mode, ungrounded in grid operation mode No grounding in any mode
57	The power grid mode allows the smart load output to remain on.	Disable(default) OP2 dIS 057	Enable OP2 ENA 057
58	Setting of the smart load output time period. * Note: When time period 1 is set to "Sta0000-End0000", it means that the smart load can output all time periods.	First time period 0000 001 058 Second time period 0000 002 058 Third time period 0000 003 058 The time setting consists of 4 digits, with the first two digits representing hours and the last two digits representing minutes. For example, Sta2300-End2059 represents the smart load output time range from 23:00 to 20:59 the next day.	Smart load output start time 0000 StA 058 Smart load output shutdown time 0000 ENd 058 Smart load output start time 0000 StA 058 Smart load output shutdown time 0000 ENd 058 Smart load output start time 0000 StA 058 Smart load output shutdown time 0000 ENd 058
59	The cut-off battery voltage point/SOC setting for the smart load output.	LOSS 480v 059 Default 42.0V, 40.0V~48.0V Settable Lithium battery mode: Default 60%, 20%~100% Settable	
60	Recovery battery voltage point/SOC setting for the smart load output.	BACT 530v 060 Default 53.0V, 48.0V~58.0V Settable Lithium battery mode: Default 90%, 20%~100% Settable	
61	Setting of PV power value for the smart load output to be turned on	PvL 00kw 061 SPE 12000 ES: Default 0KW, 0KW~12KW Settable SPE 10000 ES: Default 0KW, 0KW~10KW Settable SPE 8000 ES: Default 0KW, 0KW~8KW Settable	
62	Menu Return Settings	Disable(default) MENU dIS 062	Display screen page remains stuck

		Enable MENU ENA 062	Automatically return to the main page after no human-machine interface operation within five minutes
65	Generator run time	GEN RUN t17 HOUR 00 065	Default 00, range 01~23 The time allows Generator to work. Use 2 digits to represent the time period , setting range from 00 to 23. (eg: 02 represents the time allows Generator to run for two hours.
66	BMS Communication Loss	Enable (default) b7SE ENA 066 Disable b7SE dIS 066	If BMS Communication Loss, The inverter 04 and 20 warning Icon flashing , but enable to work for original status. If BMS Communication Loss, The inverter 04 and 20 warning Icon flashing and disable to work.(cut off the output and can't charge)
67	Feed to grid configuration	Feed to grid disable(default) FEED dIS 067 Feed to grid enable FEED ENA 067	Solar energy feed to grid disable. Solar energy feed to grid enable.
68	Set country customized Regulations *This setting is only available when the program 67 is that Feed to grid enable	South Africa(Default) FRNG SAF 068 Europe FRNG EUR 068 South America FRNG SAR 068 Asia FRNG ASA 068	If selected, acceptable feed-in grid voltage range will be195.5~253VAC. Acceptable feed-in grid frequency range will be 47~51.5Hz. If selected, acceptable feed-in grid voltage range will be184~264.5VAC. Acceptable feed-in grid frequency range will be 51.5~47.5Hz. If selected, acceptable feed-in grid voltage range will be184~264.5VAC. Acceptable feed-in grid frequency range will be 57~62Hz. If selected, acceptable feed-in grid voltage range will be195.5~253VAC. Acceptable feed-in grid frequency range will be 47.5~51.5Hz.
69	Feed grid power settings	FEED 120kw 069	The maximum feed grid power can be set SPE 12000 ES: Default 12KW, 0KW~12KW Settable SPE 10000 ES: Default 10KW, 0KW~10KW Settable SPE 8000 ES: Default 8KW, 0KW~8KW Settable
70	Battery discharge current	L99 280A 070	SPE 12000 ES: Default 280A, 0A~280A Settable SPE 10000 ES: Default 240A, 0A~240A Settable SPE 8000 ES: Default 200A, 0A~200A Settable *If Program 05 is set to Li mode. The value LXXX in the lower left corner of the LCD is the maximum allowable discharge current of the lithium battery. The middle value is to set the maximum allowable discharge current value of the battery. The smaller of the two is the current limit value of the battery feed grid.

71	Battery feed enable	Feed to grid disable(default) FEED dIS 071	battery energy feed to grid disable.
		Feed to grid enable FEED ENA 071	battery energy feed to grid enable.
72	Battery feed loss point	LOSS 460 072 Lithium battery mode: Default 40%, 30%~90% Settable The other battery mode: Default 46.0V, 46.0V~52.0V Settable	
73	Battery feedback point	BACK 540 073 Lithium battery mode: Default 80%, 40%~100% Settable The other battery mode: Default 54.0V, 48.0V~54.0V Settable	
74	Battery feed time * Note: When time period 1 is set to "Sta0000-End0000", it means that the battery can feed the grid for the entire time period	First time period	Battery feed start time 0800 5tA 074
			Battery feed shutdown time 1159 ENd 074
		Second time period	Battery feed start time 1200 5tA 074
			Battery feed shutdown time 1759 ENd 074
		Third time period	Battery feed start time 1800 5tA 074
			Battery feed shutdown time 1959 ENd 074
* There are three time periods for battery feeding that can be set, which can be achieved by setting the start feeding time and the ending feeding time. *The time setting consists of 4 digits, with the first two digits representing hours and the last two digits representing minutes. For example, Sta2300-End2059 represents battery feeding time range from 23:00 to 20:59 the next day.			
75	Grid charging time * The setting is only valid when program 67 is enabled. * Note: When time period 1 is set to "Sta0000-End0000", it means that charging can be done during the entire time period; charging takes priority over power feeding.	First time period	Grid charging start time 2000 5tA 075
			Grid charging shutdown time 2359 ENd 075
		Second time period	Grid charging start time 0000 5tA 075
			Grid charging shutdown time 0559 ENd 075
		Third time period	Grid charging start time 0600 5tA 075
			Grid charging shutdown time 0759 ENd 075

		* There are three time periods for grid charging that can be set, which can be achieved by setting the start feeding time and the ending feeding time. *The time setting consists of 4 digits, with the first two digits representing hours and the last two digits representing minutes. For example, Sta2300-End2059 represents grid charging time range from 23:00 to 20:59 the next day.	
76	Anti-backflow enable	disable(default) EtCt dIS 076	Disable external CT anti-backflow function
		enable EtCt ENA 076	Enable external CT anti-backflow function
77	External CT sampling ratio	2000 CtR 077 Default 2000, 1000~9999 Settable. For example, 2000 means the sampling ratio is 1:2000	
78	Anti-backflow power *The setting is only valid when program 76 is enabled	E11P 000 078 SPE 12000 ES: Default 0kW, 0~12.0kW Settable SPE 10000 ES: Default 0kW, 0~10.0kW Settable SPE 8000 ES: Default 0kW, 0~8.0kW Settable	*For example, the anti-backflow power is set to 2KW Single: the anti-backflow power is 2KW. Single-phase parallel: If the number of parallel machines is (n) PCS, the total anti-backflow power of the parallel system is (2 * n) KW. Three-phase parallel: If the number of three-phase parallel machines is (x/y/z) PCS, the anti-backflow power of each phase line is (2 * x / 2 * y / 2 * z) KW.
79	Grid peak shaving enable	disable(default) GrId dIS 079	Disable external CT grid peak shaving function
		enable GrId ENA 079	Enable external CT grid peak shaving function *If program 79 is enabled · Battery feeding to the grid is also enabled accordingly.
80	Grid peak shaving power *The setting is only valid when program 79 is enabled	GrId 240 080 SPE 12000 ES: Default 24kW, 0~24.0kW Settable SPE 10000 ES: Default 20kW, 0~20.0kW Settable SPE 8000 ES: Default 16kW, 0~16.0kW Settable	*For example, the grid peak shaving power is set to 2KW Single: Grid peak shaving power is 2KW. Single-phase parallel: If the number of parallel machines is (n) PCS, the total grid peak shaving power of the parallel system is (2 * n) KW. Three-phase parallel: If the number of three-phase parallel machines is (x/y/z) PCS, the grid peak shaving power of each phase line is (2 * x / 2 * y / 2 * z) KW.

4.3.2 Hide settings

1) After pressing and holding UP and DOWN buttons at the same time for 3 seconds, the unit will enter PASS mode. Change the middle three numbers 000 to 111.

Program	Description	Setting Option	
27	UpsCap query (View the UpsCap size of the current model.)	HCRP 120 027 ^o	SPE 12000 ES: The UpsCap of the current model is 12.0KW.
		HCRP 100 027 ^o	SPE 10000 ES: The UpsCap of the current model is 10.0KW.
		HCRP 80 027 ^o	SPE 8000 ES: The UpsCap of the current model is 8.0KW.
29	Grid input voltage calibration	224 ^v GRD ^v 224 ^v 029 ^o	Users can calibrate the grid voltage within a range of ± 9V based on the current grid voltage parameters displayed in the upper left corner of the LCD screen. Calibrate the grid voltage by inputting the actual grid voltage. *Note: The grid voltage must be greater than 90V for voltage calibration
30	Battery voltage calibration	499 ^v BAT ^v 499 ^v 030 ^o	Users can calibrate the battery voltage within a range of ± 9V based on the current battery voltage parameters displayed in the upper left corner of the LCD screen. Calibrate the battery voltage by inputting the actual battery voltage. * Note: The battery voltage must be greater than 40V for voltage calibration.
31	Inverter voltage calibration	115 ^v INV ^v 115 ^v 031 ^o	Users can calibrate the inverter voltage within a range of ± 9V based on the current inverter voltage parameters displayed on the LCD screen. Input half of the true inverter voltage to complete the calibration. *Note: The inverter voltage must be greater than 90V for voltage calibration
32	AC output voltage calibration	230 ^v OUT ^v 230 ^v 032 ^o	Users can calibrate the output voltage within a range of ± 9V based on the current AC output voltage parameters displayed on the LCD screen. Calibrate the AC output voltage by inputting the actual AC output voltage. Note: AC output voltage must be greater than 90V to perform voltage calibration
33	PV1 voltage calibration	299 ^v PV1 299 ^v 033 ^o	Users can perform PV1 voltage calibration within a range of ± 9V based on the current PV1 voltage parameters displayed in the upper left corner of the LCD screen. Enter the real PV1 voltage to calibrate the voltage of PV1. Note: PV1 voltage must be greater than 150V for voltage calibration
34	PV2 voltage calibration	299 ^v PV2 299 ^v 034 ^o	Users can perform PV2 voltage calibration within a range of ± 9V based on the current PV2 voltage parameters displayed in the upper left corner of the LCD screen. Enter the real PV2 voltage to calibrate the voltage of PV2. Note: PV2 voltage must be greater than 150V for voltage calibration
51	Fault restart	disable(default) FRST DIS 051 ^o	The inverter cannot automatically restart after reporting a fault.
		enable FRST ENR 051 ^o	The inverter can automatically restart after reporting a fault.

52	PV ISO detection	disable(default) PVIS DIS 052 ^o	Disable PV ISO detection function.
		enable PVIS ENR 052 ^o	Enable PV ISO detection function.
53	Redundant relay detection	disable(default) EEL DIS 053 ^o	Disable redundant relay detection function.
		enable EEL ENR 053 ^o	Enable redundant relay detection function.
63	Inverter current DC component protection	disable(default) DCI DIS 063 ^o	Disable inverter current DC component protection function.
		enable DCI ENR 063 ^o	Enable inverter current DC component protection function.
64	Generator input voltage calibration	223 ^v GEN ^v 223 ^v 064 ^o	Users can calibrate the generator voltage within a range of ± 9V based on the current generator voltage parameters displayed in the upper left corner of the LCD screen. Enter the real generator voltage to calibrate the voltage of generator *Note: The generator voltage must be greater than 90V for voltage calibration.
81	GFCI protection	disable(default) GFCI DIS 081 ^o	Disable GFCI protection function.
		enable GFCI ENR 081 ^o	Enable GFCI protection function.
82	Feed grid voltage loss protection point	FED VLL 253 ^v 195 ^v 082 ^o	High voltage loss protection point can be set range: 240-280Vac, default 253Vac. Low voltage loss protection point can be set range: 170-200Vac, default 195Vac.
83	Feed grid frequency loss protection point	50Hz system FED 50 ^{Hz} FF9 515 470 083 ^o	High frequency loss protection point can be set range: 51.0-55.0Hz, default 55Hz. Low frequency loss protection point can be set range: 45.0-49.0Hz, default 45Hz.
		60Hz system FED 60 ^{Hz} FF9 615 570 083 ^o	High frequency loss protection point can be set range: 61.0-65.0Hz, default 65Hz. Low frequency loss protection point can be set range: 55.0-59.0Hz, default 55Hz.

2) After pressing and holding UP and DOWN buttons at the same time for 3 seconds, the unit will enter PASS mode. Change the middle three numbers 000 to 305.

Program	Description	Setting Option	
35	Reset to factory settings	Reset : EE RST 035 ^o	Press the "ENTER" button twice to confirm the selection, then press "ESC" to return and complete the settings.

5. Parallel Installation Guide

Introduction

This inverter can be used in parallel with two different operation modes.

1. Parallel operation in single phase with up to 9 units.
2. Maximum 9 units work together to support 3-phase equipment. 7 units support one phase maximum.

5.1 Parallel accessories



▶ Parallel communication cable

5.2 Points of Attention for Parallel

- Ensure that all breakers in the line on the load side are disconnected.
- Be sure the length of all battery cables is the same. Otherwise, there will be voltage difference between inverter and battery to cause parallel inverters not working.
- Be sure that all inverters will share the same battery bank. Otherwise, the inverters will transfer to fault mode.
- Each inverter in the parallel system can only be connected to a separate PV string, and it is prohibited for multiple PV ports to share the same string, and there is a risk of blowing up the inverter.
- Recommended battery capacity

Inverter parallel numbers	2	3	4	5	6	7	8	9
SPE 12000 ES-Battery Capacity	800AH	1200AH	1600AH	2000AH	2400AH	2800AH	3200AH	3600AH
SPE 10000 ES-Battery Capacity	600AH	900AH	1200AH	1500AH	1800AH	2100AH	2400AH	2700AH
SPE 8000 ES-Battery Capacity	600AH	900AH	1200AH	1500AH	1800AH	2100AH	2400AH	2700AH

5.3 Wire Connections

5.3.1 Single-phase parallel wire connection

Port	Parallel mode	Charts and descriptions
		When the inverters are connected in parallel, the + wires are connected together and the - wires are connected together at the DC input. (chart below)
DC Input	left-positive, right-negative	In the inverter parallel system, each inverter battery needs to be connected to a DC circuit breaker, single access circuit breaker specifications recommended 400 A. If you choose to access the total circuit breaker at the system end, the recommended access circuit breaker specifications 400 A * the number of parallel (eg: four inverter system access to the total circuit breaker, the recommended access circuit breaker specifications 1600A).

Grid	<p>When the inverters are connected in parallel, the N wires are connected together and the L wires are connected together at the Grid. (chart below)</p>
Generator	<p>In an inverter-parallel system, an AC circuit breaker is required to be connected to the utility for each inverter, and a single access circuit breaker size of 70A is recommended.</p> <p>When the inverters are connected in parallel, the N wires are connected together and the L wires are connected together at the generator input. (chart below)</p>
AC Output	<p>When the inverters are connected in parallel, the N wires are connected together and the L wires are connected together at the AC output. (chart below)</p> <p>In an inverter-parallel system, an AC circuit breaker is required to be connected to the load for each inverter, and a single access circuit breaker size of 70A is recommended.</p>
PV Input	<p>Each inverter in the system is individually connected to the PV string. (chart below)</p>
Parallel communication port	<p>Please put the CAN communication DIP to on status for the first and the end inverter.</p>
Lithium BMS Communication port	<p>Make sure to connect the BMS communication cable between the battery and one inverter of the parallel system. It's recommended to connect to the master inverter of the parallel system.</p>

5.3.2 Three-phase parallel wire connection

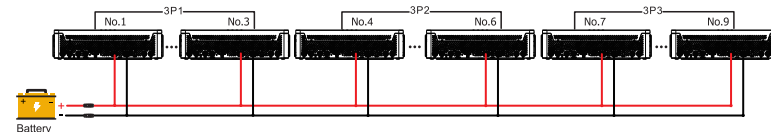
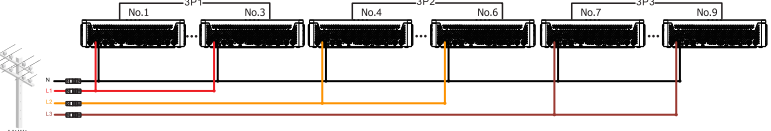
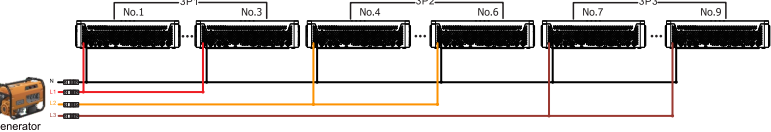
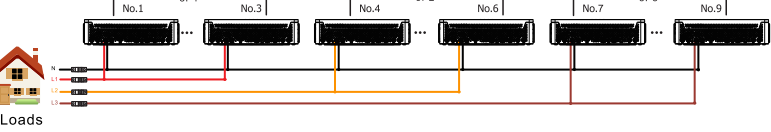
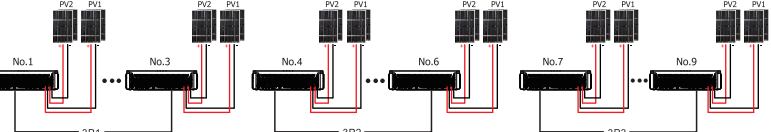
parallel mode	Charts and descriptions
Port	Charts and descriptions
DC Input left-positive, right-negative	<p>When the inverters are connected in parallel, the + wires are connected together and the - wires are connected together of the DC input. (chart below)</p>  <p>In the inverter parallel system, each inverter battery needs to be connected to a DC circuit breaker, single access circuit breaker specifications recommended 400 A. If you choose to access the total circuit breaker at the system end, the recommended access circuit breaker specifications 400 A * the number of parallel (eg: four inverter system access to the total circuit breaker, the recommended access circuit breaker specifications 1600A)</p>
Grid	<p>After the inverter is connected in parallel, at the Grid, the N wires are connected together and the L wires are connected together of each phase (chart below).</p>  <p>In an inverter-parallel system, an AC circuit breaker is required to be connected to the utility for each inverter, and a single access circuit breaker size of 70A is recommended.</p>
Generator	<p>After the inverter is connected in parallel, at the generator input, the N wires are connected together and the L wires are connected together of each phase (chart below).</p> 
AC Output	<p>After the inverter is connected in parallel, at the AC output, the N wires are connected together and the L wires are connected together of each phase (chart below).</p>  <p>In an inverter-parallel system, an AC circuit breaker is required to be connected to the utility for each load, and a single access circuit breaker size of 70A is recommended.</p>
PV Input	<p>Each inverter in the system is individually connected to the PV string (chart below)</p> 

Please put the CAN communication DIP to on status for the first and the end inverter.

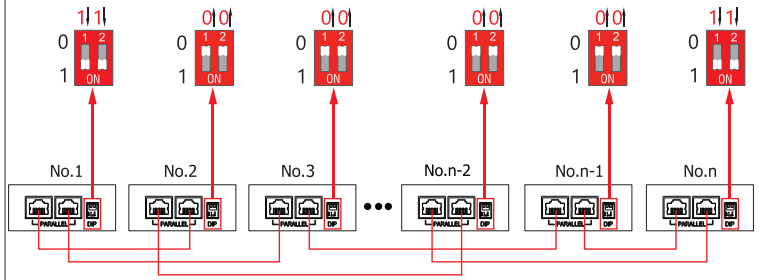

Parallel communication port

Make sure to connect the BMS communication cable between the battery and one inverter of the parallel system. It's recommended to connect to the master inverter of the parallel system.

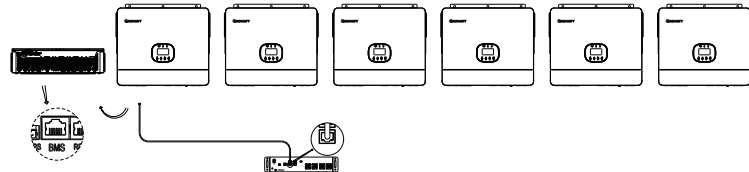

Lithium BMS communication port

5.3.3 CT wire connection

The following introduces the CT wire connection method of single-phase parallel system and three-phase parallel system.

Single-phase parallel wire connection

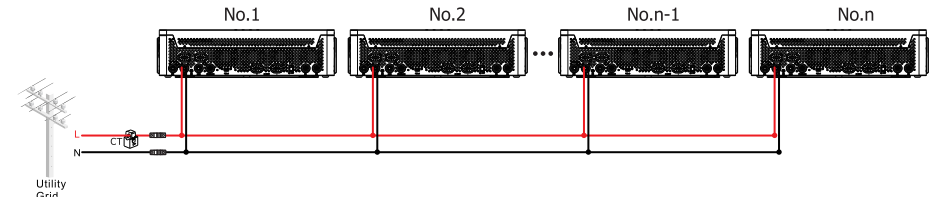

Only one CT needs to be connected to the inverter NO.1 and placed near the meter. Other inverters no longer need an external CT, and the entire single-phase parallel system only needs one external CT.

three-phase parallel wire connection

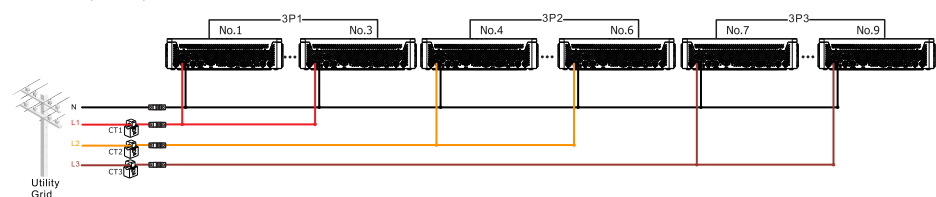

Select one inverter in each of the three phases to connect to the CT. The entire three-phase parallel system requires three external CTs, which are placed near the meter.

5.4 Parallel Example

Parallel Operation in Single Phase

Single-phase parallel master and slave do not need to be set, the system automatically assigns the master and slave according to the order of start-up, the first one to start is the master, and the rest are the slaves. Be sure to confirm that the wiring is correct, the wiring is shown in the following figure. **Nine inverters in parallel:**

Power Connection

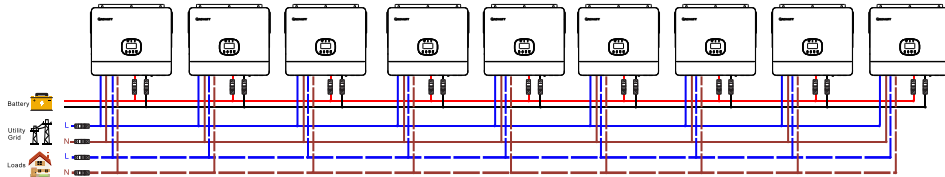

Parallel Operation in Three Phase

Try to connect to the utility at the same time after three-phase parallel connection.

When setting up three-phase parallel, you need to define the master and the slave, see the 5.5 for the specific setting method. Be sure to confirm that the wiring is correct, the wiring method is shown in the table below. The

following chart is an example of (3+3+3) (4+3+2)

(3+3+3) Three inverters in one phase, three inverters in second phase and three inverters for the third phase:

Power Connection

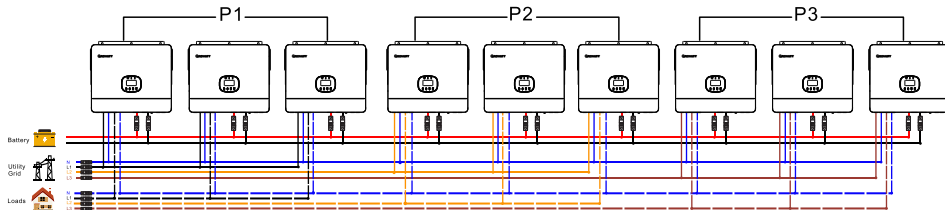

(4+3+2) Four inverters in one phase, three inverters in second phase and two inverters for the third phase:

Power Connection

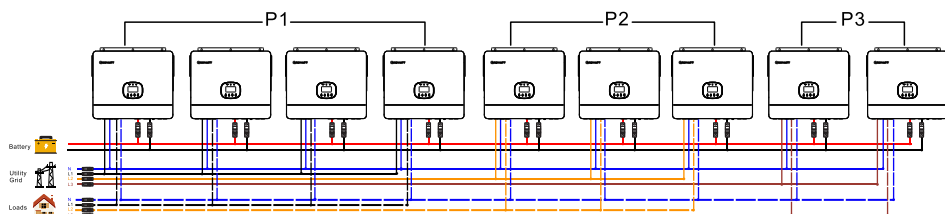

5.5 Parallel setup and display

Refer to Program 23 on Page 23

Parallel in Single Phase

Step 1: Check the following requirements before commissioning:

- Correct wire connection
- Ensure all breakers in Line wires of load side are open and each Neutral wires of each unit are connected together.

Step 2: Turn on each unit and set "PAL" in LCD setting program 23 of each unit. And then shut down all units.

Note: It's necessary to turn off switch when setting LCD program. Otherwise, the setting cannot be programmed.

Step 3: Turn on each unit.

LCD display in Master unit	LCD display in Slave unit

Note: Master and slave units are randomly defined.

Step 4: Switch on all AC breakers of Line wires in AC input. It's better to have all inverters connect to utility at the same time. If not, it will display warning 15.

LCD display in Master unit	LCD display in Slave unit

Step 5: If there is no more fault alarm, the parallel system is completely installed.

Step 6: Please switch on all breakers of Line wires in load side. This system will start to provide power to the load.

Parallel in Three Phase

Step 1: Check the following requirements before commissioning:

- Correct wire connection
- Ensure all breakers in Line wires of load side are open and each Neutral wires of each unit are connected together.

Step 2: Turn on all units and configure LCD program 23 as P1, P2 and P3 sequentially. Then shut down all units.

Note: It's necessary to turn off switch when setting LCD program. Otherwise, the setting cannot be programmed.

Step 3: Turn on all units sequentially. Please turn on HOST inverter first, then turn on the rest one by one.

LCD display in L1-phase unit	LCD display in L2-phase unit	LCD display in L3-phase unit

Step 4: Switch on all AC breakers of Line wires in AC input. If AC connection is detected and three phases are matched with unit setting, they will work normally. Otherwise, they will display warning 15/16 and will not work in the line mode.

LCD display in L1-phase unit	LCD display in L2-phase unit	LCD display in L3-phase unit

Step 5: If there is no more fault alarm, the system to support 3-phase equipment is completely installed.

Step 6: Please switch on all breakers of Line wires in load side. This system will start to provide power to the load.

Note 1: If there's only one inverter in L1-phase, the LCD will show as "HST". If there is more than one inverter in L1-phase, the LCD of the HOST inverter will show as "HST", the rest of L1-phase inverters will show as "3P1".

Note 2: To avoid overload occurring, before turning on breakers in load side, it's better to have whole system in operation first.

Note 3: Transfer time for this operation exists. Power interruption may happen to critical devices, which cannot bear transfer time.

Note 4: In a single-phase parallel system, when some inverters are connected to solar energy, energy can be obtained from the AC output end due to the parallel connection of the AC output end, resulting in energy transmission between inverters. Therefore, the AC input and AC output power displayed on the LCD display screen of a single inverter cannot accurately represent the energy flow of the inverter. It needs to be judged based on the total AC input and AC output power of the entire parallel system. (This phenomenon also exists between inverters in the same phase in a three-phase parallel system).

5.6 Example of a parallel system diagram

Single-phase parallel wire connection:

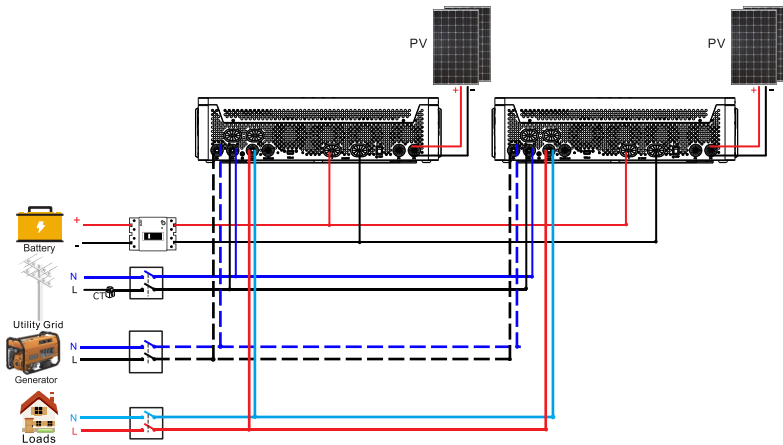

Three-phase parallel wire connection:

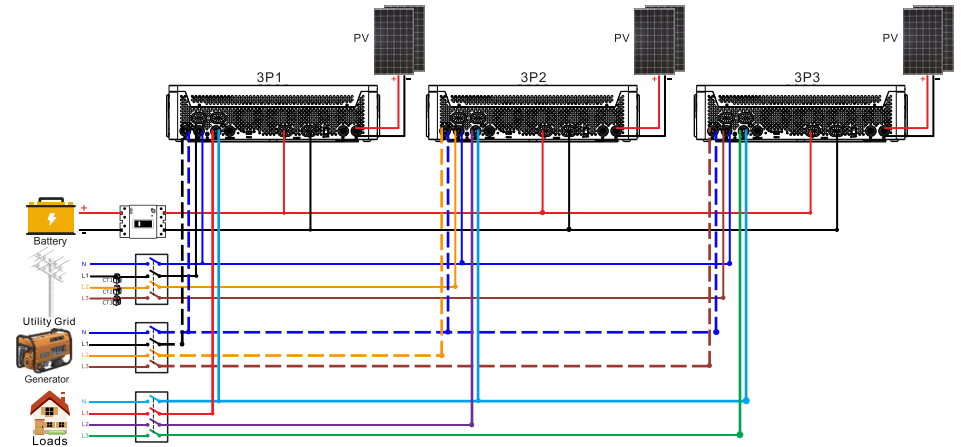

6. Fault Reference Code

6.1 Fault Reference Code

Fault Code	Fault Event	Icon on
02	Over temperature	02
03	Battery voltage is too high	03
05	Output short circuited	05
06	Output voltage is too high.	06
07	Overload time out	07
08	Bus voltage is too high	08
09	Bus soft start failed	09
11	The main relay failed	11
51	Over current or surge	51
52	Bus voltage is too low	52
53	Inverter soft start failed	53
58	Output voltage is too low	58
60	Negative power fault	60
61	PV voltage is too high	61
62	Internal communication error	62
65	BUS voltage imbalance	65
66	GFCI is too high	66
67	DCI failed	67
80	CAN fault	80

6.2 Warning Indicator

Warning Code	Warning Event	Audible Alarm	Icon flashing
01	Fan is locked when inverter is on	Beep 3 times every second	01
02	Over temperature	Beep once every second	02
03	Battery is over-charged	Beep once every second	03
04	Low battery	Beep once every second	04
07	Overload	Beep once every 0.5 second	07
10	Output power derating	Beep twice every 3 seconds	10
13	Solar charger stops due to high PV voltage	Beep once every second	13
14	Solar charger stops due to overload	Beep once every second	14
15	Parallel input utility grid different	Beep once every second	15
16	Parallel input phase error	Beep once every second	16
17	Parallel output phase loss	Beep once every second	17
18	BUS over current	Beep once every second	18
19	Battery disconnect	No beep	19
20	BMS communication error	Beep once every second	20
21	PV power insufficient	Beep once every second	21
22	Parallel forbidden without battery	Beep once every second	22
23	The parallel version is different	Beep once every second	23
25	Parallel inverters' capacity different	Beep once every second	25
26	ISO detection failed	Beep once every second	26
28	GFCI error	Beep once every second	28
29	LLC overcurrent	Beep once every second	29
30	BUS low voltage	Beep once every second	30
31	Inconsistent switches	Beep once every second	31
36	Total over voltage	Beep once every second	36
37	Total under voltage	Beep once every second	37
38	Discharge over voltage	Beep once every second	38
39	Charge over voltage	Beep once every second	39
40	Discharge over temperature	Beep once every second	40
41	Charge over temperature	Beep once every second	41
81	Host loss	Beep once every second	81

7. Specifications

7.1 PV Specification

It's applicable to Grid Tie & Hybrid & Off Grid			
Model	SPE 12000 ES	SPE 10000 ES	SPE 8000 ES
Max. power	15000W	12500W	10000W
Max. PV Array Open Circuit Voltage	550Vdc		
Nominal PV Voltage	380Vdc	380Vdc	380Vdc
PV Start-up Voltage	120Vdc±10V		
PV Array Voltage High Loss	550Vdc		
PV Array Voltage High Comeback	520Vdc		
PV Array Voltage Low Loss	60Vdc		
PV Array Voltage Low Back	120Vdc		
PV MPPT Voltage Range	60Vdc ~ 480Vdc		
PV MPPT Voltage Low Loss	60Vdc		
PV MPPT Voltage Low Back	70Vdc		
Number of MPP Trackers	2		
Max. DC Input current/ per string	2*27Amp	2*27Amp	2*27Amp
PV Voltage Accuracy	+/-5V		

7.2 AC Input Specification

It's applicable to Hybrid & Off-Grid			
Model	SPE 12000 ES	SPE 10000 ES	SPE 8000 ES
Nominal Input Voltage	230Vac		
Low Loss Voltage	170Vac±7V(UPS); 90Vac±7V(Appliances)		
Low Loss Return Voltage	180Vac±7V(UPS); 100Vac±7V (Appliances)		
High Loss Voltage	280Vac±7V		
High Loss Return Voltage	270Vac±7V		
Max AC Input Voltage	300Vac		
Nominal Input Frequency	50Hz / 60Hz (Auto detection)		
AC input frequency range	40.0 ~ 65.0Hz		
AC input frequency comeback value	42.0/63.0Hz		
Max. AC Input current	70Amp (Include Loads and Charging)		
Rating of Transfer Relay	70Amp (Include Loads and Charging)		

7.3 Grid Feeding Specification

It's applicable to Grid-tie & Hybrid			
Model	SPE 12000 ES	SPE 10000 ES	SPE 8000 ES
Nominal output voltage	230Vac		
Nominal output frequency	50Hz / 60Hz (Auto detection)		
Max feeding power	12000W	10000W	8000W
Output voltage range	195.5~253.0VAC (±3%) @Asia regulation 184~264.5VAC (±3%) @Europe regulation 184.0~264.5VAC (±3%) @South America regulation 195.5~253.0VAC (±3%) @South Africa regulation (default)		
Output voltage comeback value	205.0~243.0VAC (±3%) @Asia regulation 194.0~254.5VAC (±3%) @Europe regulation 194.0~254.5VAC (±3%) @South America regulation 195.5~253.0VAC (±3%) @South Africa regulation (default)		

Operational frequency range	49.0~51.0Hz (±0.1Hz) @Asia regulation 47.5~51.5Hz (±0.1Hz) @Europe regulation 57.0~62.0Hz (±0.1Hz) @South America regulation 47.0Hz~51.5Hz (±3%)@South Africa regulation (default)		
Output frequency comeback value	49.5~50.5Hz (±0.1Hz) @Asia regulation 48~51Hz (±0.1Hz) @Europe regulation 57.5~61.5Hz (±0.1Hz) @South America regulation 47.0~51.5Hz (±0.1Hz) @South Africa regulation (default)		
Output current	52.2A	43.5A	34.8A
O/P current distortion	<5%		
O/P current DC component	<300mA	<250mA	<200mA
Power Factor	0.8 leading to 0.8 lagging		
Max. Conversion Efficiency(PV/AC)	96.5%		
European Efficiency@ V nominal (PV/AC)	95.5%		

7.4 Battery Mode Specification

It's applicable to Grid-tie & Hybrid			
Model	SPE 12000 ES	SPE 10000 ES	SPE 8000 ES
Nominal Output Power	12000W	10000W	8000W
Max Discharge Current	280A	240A	200A
Waveform	Pure Sine Wave		
Nominal Output Voltage	230Vac		
Nominal Output Frequency	50/60Hz auto sensing		
Output Voltage Distortion	<3% for linear load, <5% for non-linear load @ V nominal		
Output DC offset	<150mV		
Peak Efficiency	95%		
No Load Power Consumption	<75W@Rate Voltage		
Transfer Time	<20ms@Single <30ms @ Parallel		
Output Parallel-able	Yes		

7.5 Two Load Output Power Specification

It's applicable to Hybrid & Off-Grid			
Model	SPE 12000 ES	SPE 10000 ES	SPE 8000 ES
Full Load Output Power	12000W	10000W	8000W
Maximum Main Load	12000W	10000W	8000W
Maximum smart load	8000W	8000W	8000W

7.6 Overload Capability Specification

It's applicable to Hybrid & Off-Grid	
Line Mode	@>70A AC input current, 1min
Battery Mode	5sec, @>120% Load
	10sec, @103%~120%
	4-cycle, short-circuits

7.7 Battery & Charger Specification

It's applicable to Hybrid & Off-Grid			
Model	SPE 12000 ES	SPE 10000 ES	SPE 8000 ES
Nominal DC Voltage	48Vdc		
Cold Start Voltage(Lead-Acid Mode)	46.0Vdc		
Cold Start SOC(Li Mode)	Default 30%, Low DC Cut-off SOC +10%		
Low DC Warning Voltage (Lead-Acid Mode)	44.0Vdc @ load < 20% 42.8Vdc @ 20% ≤ load < 50% 40.4Vdc @ load ≥ 50%		
Low DC Warning Recovery Voltage (Lead-Acid Mode)	46.0Vdc @ load < 20% 44.8Vdc @ 20% ≤ load < 50% 42.4Vdc @ load ≥ 50%		
Low DC Cut-off Voltage (Lead-Acid Mode)	42.0Vdc @ load < 20% 40.8Vdc @ 20% ≤ load < 50% 38.4Vdc @ load ≥ 50%		
Low DC Warning SOC (Li Mode)	Low DC Cut-off SOC +5%		
Low DC Warning Return SOC (Li Mode)	Low DC Cut-off SOC +10%		
Low DC Cut-off SOC(Li Mode)	Default 20%, 5%~50% settable		
High DC Recovery Voltage	56.4Vdc(C.V. charging voltage)		
High DC Cut-off Voltage	60Vdc		
Max. AC Charging Current	250Amp	220Amp	190Amp
Max. Solar Charging Current	250Amp	220Amp	190Amp
Max. Charging Current	250Amp	220Amp	190Amp
Absorption Charging Voltage	56.4Vdc		
Floating Charging Voltage	54.0Vdc		
Overcharge Protection	60Vdc		
Charging Algorithm	3-step		
Charging process based on default setting. 3 stages: First – max. charging voltage increases to 56V; Second- charging voltage will maintain at 56V until charging current is down to 5 Amp. or after 12 hours of continuous charging; Third- go to floating charging at 54V.			

7.8 Environmental

Model	SPE 12000 ES	SPE 10000 ES	SPE 8000 ES
Operation Temperature Range	-10°C ~ 50°C		
Storage Temperature Range	-15°C ~ 60°C		
Altitude	<2000m		
Relative humidity	5% ~ 95% non-condensing		
Audible Noise	<75dB		
Cooling	DC FAN		
Safety Certification	CE		

7.9 Mechanical Specification

Model	SPE 12000 ES	SPE 10000 ES	SPE 8000 ES
Housing Dimension (L*W*H), mm	550*465*150 mm	550*465*150mm	550*465*150mm
Packing Dimension (L*W*H), mm	705*625*260 mm	705*625*260mm	705*625*260mm
Housing Color	White	White	White
Net Weight, kg	21.5	21.5	21.5
Gross Weight, kg	25.5	25.5	25.5

8. Appendix

Appendix I. Fault information and processing

The energy storage inverter is designed according to the off-grid connected operation standard and meets the safety requirements and electromagnetic compatibility requirements. Before leaving the factory, the inverter undergoes several rigorous tests to ensure that the inverter can operate reliably.



If any of the fault messages listed in Table 6-1 appear on your inverter and the fault has not been removed after restarting, please contact your local dealer or service center. You need to have the following information ready.

1. Inverter serial number;
2. The problem description (including the fault code and indicator status displayed on the LCD, or specific fault video and picture) is as detailed as possible.
3. Basic system component information (such as batteries, photovoltaic panels, load usage and specifications)
4. Your contact information.

In order to give you a clearer understanding of the inverter's fault information, we will list all possible fault codes and their descriptions when the inverter is not working properly

error code	Description	Solutions
F01	Fan is locked	1.Check whether all fans are working properly. 2.Replace the fan.
F02	Internal temperature of component is over 100°C.	Check whether the air flow of the unit is blocked or whether the ambient temperature is too high.
F03	Battery is over-charged.	Restart the unit
	The battery voltage is too high	1.Measure battery voltage in DC input. (Check battery SOC in LCD when use Li battery) 2.Adjust the charging current to less than 0.2C 3.Check if spec and quantity of batteries are meet requirements.
W04	Battery voltage is too low	1.Measure battery voltage in DC input. (Check battery SOC in LCD when use Li battery) 2.Recharge the battery.
F05	Output short circuited	1.Disconnect load and restart the unit 2.Check if wiring is connected well and remove abnormal load.
F07	Overload time out	Reduce the connected load by switching off some equipment.
F08	Bus voltage is too high	1. If you connect to a lithium battery without communication, check whether the voltage points of the program 19 and 21 are too high for the lithium battery. 2. Restart the unit
F11/F12	Relay detection failed	Restart the unit
F09/F53/F57	Bus soft start failed	Restart the unit
W15	The input status is different in parallel system.	Check if AC input wires of all inverters are connected well.
W16	Input phase is not correct.	Change the input phase S and T wiring.
W17	The output phase not correct in parallel.	1.Make sure the parallel setting is the same System (single or parallel; 3P1,3P2,3P3). 2.Make sure all phases inverters are power on.
W19	lead acid battery disconnect	Check if spec and quantity of batteries are meet requirements.
	Lithium battery disconnect	1. Check BMS communication cable connection 2. Check setup parameters

W20	BMS communication error	1. Check whether communication line is correct connection between inverter and battery. 2. Check whether BMS protocol type is correct setting.
W31	Inconsistent switches	Check if all inverter switches are closed
F29/F51	Over current or surge	Restart the unit
F52	Bus voltage is too low	Restart the unit
F55	Output voltage is unbalanced	Restart the unit
F61	PV voltage is too high	1. Measure whether the PV voltage in the DC input is consistent with the value displayed on the LCD screen. 2. If consistent, standardize the parallel connection method of PV panels.
F62	Internal communication error	Restart the unit
F65	BUS voltage imbalance	Restart the unit
F66	GFCI is too high	1.Check if the load equipment has a leakage phenomenon 2. Restart the unit
F67	DCI failed	Restart the unit
F80	CAN fault	1. Check whether the parallel communication cables are connected well.
F81	Host loss	2. Check whether Program 23 settings are right for the parallel system.

Other Problem	LCD/LED/Buzzer	Explanation	What to do
Unit shuts down Automatically during startup process.	LCD/LEDs and buzzer will be active for 3 seconds and then complete off.	The battery voltage is too low. (<1.91V/Cell)	1. Re-charge battery. 2. Replace battery.
No response after power on.	No indication.	1.The battery voltage is far too low. (<1.4V/Cell) 2.Battery polarity is connected reversed.	1.Check if batteries and the wiring are connected well. 2.Re-charge battery. 3.Replace battery.
Mains exist but the unit works in battery mode.	Input voltage is 0 on the LCD and green LED is flashing.	Input protector is tripped.	Check if AC breaker is tripped and AC wiring is connected well.
	Green LED is flashing.	Insufficient quality of AC power (Shore or Generator)	1.Check if AC wires are too thin and/or too long. 2.Check if generator (if applied) is working well or if input voltage range setting is correct. (UPS → Appliance)
	Green LED is flashing.	Set "Battery First" or "Solar First" as the priority of output source.	Change output source priority to Utility first.
When it's turned on,internal relay is switching on and off repeatedly.	LCD display and LEDs are flashing	Battery is disconnected.	Check if battery wires are connected well.

Note: To restart the inverter, all power sources need to be disconnected. After the LCD screen light is off, only use the battery to boot.

Appendix II Restore factory settings

After pressing and holding UP and DOWN buttons at the same time for 3 seconds, the unit will enter PASS mode. Change the middle three numbers 000 to 305. Press the "ENTER" button twice to confirm the selection, then press "ESC" to return and complete the settings.

Program	Setting Option
PASS	PASS 305 000

Appendix III Battery Equalization

43	Battery equalization	Battery equalization enable EQ ENR 043	Battery equalization disable(default) EQ DIS 043
		If "Flooded" or "User-Defined" is selected in program 05, this program can be set up.	
44	Battery equalization voltage	EQV 58.4 044 Default 58.4V, 48.0V~58.4V Settable	
45	Battery equalized time	EQT 60 045	Default 60min, 5min~900min Settable
46	Battery equalized timeout	EQE 120 046	Default 120min, 5min~900min Settable
47	Equalization interval	EQI 30 047	Default 30days, 1 days~90 days Settable
48	Equalization activated immediately	Equalization activated immediately on EQ ON 048	Equalization activated immediately off(default) EQ OFF 048
		If equalization function is enabled in program 43, this program can be setup. If "On" is selected in this program, it's to activate battery equalization immediately and LCD main page will show "EQ". If "Off" is selected, it will cancel equalization function until next activated equalization time arrives based on program 47 setting. At this time, "EQ" will not be shown in LCD main page.	

Equalization function is added into charge controller. It reverses the buildup of negative chemical effects like stratification, a condition where acid concentration is greater at the bottom of the battery than at the top. Equalization also helps to remove sulfate crystals that might have built up on the plates. If left unchecked, this condition, called sulfation, will reduce the overall capacity of the battery. Therefore, it's recommended to equalize battery periodically.

● How to Apply Equalization Function

You must enable battery equalization function in monitoring LCD setting program 43 first. Then, you may apply this function in device by either one of following methods:

1. Setting equalization interval in program 47.
2. Active equalization immediately in program 48.

● When to Equalize

In float stage, when the setting equalization interval (battery equalization cycle) is arrived, or equalization is active immediately, the controller will start to enter Equalize stage.

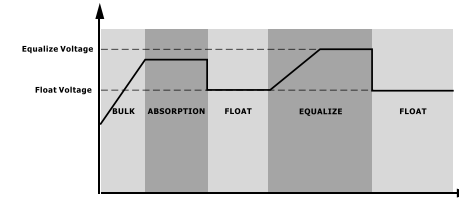

● Equalize charging time and timeout

In Equalize stage, the controller will supply power to charge battery as much as possible until battery voltage raises to battery equalization voltage. Then, constant-voltage regulation is applied to maintain battery voltage at the battery equalization voltage. The battery will remain in the Equalize stage until setting battery equalized time is arrived.

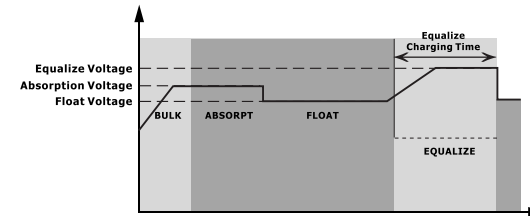

However, in Equalize stage, when battery equalized time is expired and battery voltage doesn't rise to battery equalization voltage point, the charge controller will extend the battery equalized time until battery voltage achieves battery equalization voltage. If battery voltage is still lower than battery equalization voltage when battery equalized timeout setting is over, the charge controller will stop equalization and return to float stage.

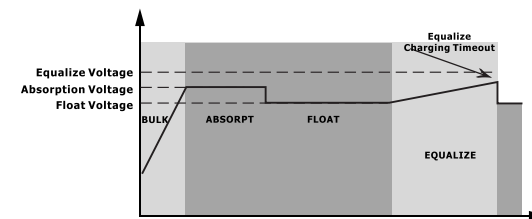

Appendix IV Routine maintenance

To ensure the long-term and good operation of the energy storage system, it is recommended to perform the routine maintenance as described in this section (Cleaning and maintenance of the inverter must be carried out with the power supply disconnected to ensure personal safety.)

Items	Methods	Maintenance interval
System cleanliness for inverter	<ul style="list-style-type: none"> ● Regularly check the surface of the inverter for dust or other debris and clean it with a dust sponge. 	Once every six months to one year
	<ul style="list-style-type: none"> ● Regularly check that radiators and vents are not covered with dust and clean them with a soft brush or compressed air. 	Once every 3 months.
Electrical connection	<ul style="list-style-type: none"> ● Check if any cable connection is off or loose. 	Half a year after first debugging and testing, and once every six months to one year thereafter.
	<ul style="list-style-type: none"> ● Check if any cable is damaged, and especially if there are cuts on the sheath where the cable contacts with the metal surface. 	
	<ul style="list-style-type: none"> ● Check the internal circuit boards and components of the inverter for abnormalities, such as damage, discoloration, etc., and repair and replace them in a timely manner. 	
Grounding reliability	Check if the grounding cable is grounded reliably.	
Normal operation	Periodically check the input voltage, output voltage and current of the inverter to ensure that it is operating within its rated range.	
	Regularly check the operating status and performance parameters of the inverter via the inverter's monitoring system or display.	
Other Maintenance	Ensure that the inverter is installed in a dry, well-ventilated environment, protected from humidity, heat or excessive dust.	

Appendix V WIFI Monitoring

Plug cube WIFI into the WIFI/4G port. Scan the QR code below to download ShinePhone, also you can search ShinePhone in iOS or Google Play Store, download and install it.

Note: 1. Make sure you download the latest version.
2. For further information please visit server. growatt.com

