



Smart
connections.

Operating manual

PLENTICORE BI

Legal notice

KOSTAL Solar Electric GmbH
Hanferstraße 6
79108 Freiburg i. Br.
Germany
Phone +49 (0)761 477 44 - 100
Fax +49 (0)761 477 44 - 111
www.kostal-solar-electric.com

Exclusion of liability

All names, trademarks, product names or other designations used in this manual may be legally protected even if not indicated as such (e.g. as a trademark). KOSTAL Solar Electric GmbH assumes no liability or warranty for their free usage. The illustrations and texts have been compiled with great care. However, the possibility of errors cannot be ruled out. The compilation is made without any guarantee.

General note on gender equality

KOSTAL Solar Electric GmbH is aware of the importance of language with regard to the equality of women and men and always makes an effort to reflect this in the documentation. Nevertheless, for the sake of readability we are unable to use non-gender-specific terms throughout and use the masculine form instead.

© 2020 KOSTAL Solar Electric GmbH

All rights reserved by KOSTAL Solar Electric GmbH, including those of reproduction by photocopy and storage in electronic media. Commercial use or distribution of the texts, displayed models, diagrams and photographs appearing in this product is not permitted. This manual may not be reproduced, stored, transmitted or translated in any form or by means of any medium, in whole or in part, without prior written permission.

Valid from version:

User Interface (UI): 01.14.0000
Firmware (FW): 1.42

Contents

1. General information	6
1.1 Proper use	8
1.2 EU declarations of conformity	11
1.3 About this manual	12
1.4 Notes in this manual	14
1.5 Symbols used	18
1.6 Labels on the device	19
2. Device and system description	20
2.1 System overview	21
2.2 The battery inverter	22
2.3 Functions	28
3. Installation	37
3.1 Transport and storage	38
3.2 Scope of delivery	39
3.3 Installation	40
3.4 Electrical connection	43
3.5 Overview of Smart Communication Board (SCB)	47
3.6 Connecting energy meter	48
3.7 Communication connection	50
3.8 Connecting battery	53
3.9 Closing battery inverter	56
3.10 Connecting battery's DC cables	57
3.11 Initial commissioning	59
3.12 Configuring settings in the Webserver	63
4. Operation and operating the device	64
4.1 Switching on the battery inverter	65
4.2 Switching off the battery inverter	66
4.3 De-energise the battery inverter	67
4.4 Control panel	69
4.5 Operational status (display)	72
4.6 Operational status (LEDs)	75
4.7 The menu structure of the battery inverter	76

5.	Connection types	88
5.1	Battery inverter/computer connection	89
5.2	Settings on the computer	90
5.3	Battery inverter / computer connection	91
5.4	Disconnecting battery inverter/computer connection	93
5.5	Connection via KOSTAL Solar App	94
6.	Webserver	95
6.1	The Webserver	96
6.2	Calling up the Webserver	98
6.3	Menu structure of Webserver	100
6.4	Webserver menus	105
6.5	The battery use strategy	130
7.	System monitoring	132
7.1	The log data	133
7.2	Retrieving, saving and graphically depicting log data	137
7.3	The KOSTAL Solar Portal	139
7.4	Remote service	140
8.	External battery control	141
8.1	External battery control	142
8.2	External battery control via Modbus (TCP)	143
8.3	External battery control via digital inputs	145
9.	Maintenance	147
9.1	Maintenance and cleaning	148
9.2	Housing cleaning	149
9.3	Fan cleaning	150
9.4	Updating software	154
9.5	Event codes	156
10.	Technical data	157
10.1	Technical data	158
10.2	Block diagram	162
11.	Accessories	163
11.1	KOSTAL Solar Portal	164
11.2	KOSTAL Solar App	165

12. Appendix	166
12.1 Type plate	167
12.2 Warranty and service	168
12.3 Handover to the operator	169
12.4 Decommissioning and disposal	170
Index	171

1. General information

1.1	Proper use	8
1.2	EU declarations of conformity	11
1.3	About this manual	12
1.4	Notes in this manual	14
1.5	Symbols used	18
1.6	Labels on the device	19

Thank you for choosing a battery inverter from KOSTAL Solar Electric GmbH.

If you have any technical questions, please call our service hotline:

- Germany and other countries¹
+49 (0)761 477 44 - 222
- Switzerland
+41 32 5800 225
- France, Belgium, Luxembourg
+33 16138 4117
- Greece
+30 2310 477 555
- Italy
+39 011 97 82 420
- Spain, Portugal²
+34 961 824 927

¹ Language: German, English

² Language: Spanish, English

1.1 Proper use

The battery inverter with connected battery storage is used to store AC power produced in the house grid, e.g. by PV systems, combined heat and power (CHP) units or small wind turbines. The stored energy can then be used for self-consumption in the house grid.

The device may only be used in grid-connected systems within the intended power range and under the permissible ambient conditions. The device is not intended for mobile use.

Inappropriate use may lead to injury or even death for the user or third parties. Material damage to the device and other equipment can also occur. The battery inverter may therefore only be used for its intended purpose.

The battery inverter may only be used together with battery systems which have been approved for this battery inverter by KOSTAL Solar Electric GmbH.

All components fitted on the battery inverter or in the system must satisfy the standards and guidelines that apply in the country of installation.

Exclusion of liability

Any use that differs from that described in **Ch. 1.1** or goes beyond the stated intended purpose, is considered inappropriate. The manufacturer accepts no liability for any damage resulting from this. Changes to the battery inverter are prohibited. The battery inverter may only be used if it is safe to operate and is in a technically sound condition. Any instance of misuse will result in the termination of the warranty, guarantee and general liability of the manufacturer.

Only a qualified electrician may open the device. The battery inverter must be installed by a trained electrician (according to DIN VDE 1000-10 or BGV A3 accident prevention regulations or an internationally comparable standard) who is responsible for observing the applicable standards and regulations.

Work that could affect the electrical power system of the relevant energy supply company at the site of the solar power feed-in, may only be carried out by qualified electricians expressly authorised (licensed) by the energy supply company. This includes changes to the factory-preset parameters. The installer must always observe the regulations of the energy supply company.

Factory settings may only be changed by qualified electrical installers or persons with at least comparable or higher technical qualifications, e.g. foremen, technicians or engineers. When doing so, all requirements are to be observed.



IMPORTANT INFORMATION

The battery inverter may only be installed, maintained and repaired by a trained and qualified electrician.

The electrician is responsible for ensuring that the applicable standards and regulations are observed and implemented. Work that could affect the electrical power system of the relevant energy supply company at the site of the solar power feed-in, may only be carried out by qualified electricians expressly authorised (licensed) by the energy supply company.

This includes changes to the factory-preset parameters.

Open Source licence

This product contains Open Source software, developed by third parties and licensed using licenses including GPL and/or LGPL.

For more details of this, a list of the Open Source software used and the related license texts, go to the Licences section on the battery inverter's website (Websserver)  **Ch. 6.**

1.2 EU declarations of conformity

KOSTAL Solar Electric GmbH hereby declares that the battery inverter described in this document complies with the basic requirements and other relevant conditions of the directives listed below.

- Directive 2014/30/EU
(on the approximation of the laws of the Member States relating to electromagnetic compatibility (EMC))
- Directive 2014/35/EU
(on the harmonisation of the laws of the Member States relating to the making available on the market of electrical equipment designed for use within certain voltage limits – in short: Low Voltage Directive)
- Directive 2011/65/EU (RoHS)
on the restriction of the use of certain hazardous substances in electrical and electronic equipment

You will find a detailed EU Declaration of Conformity in the download area at:

www.kostal-solar-electric.com

1.3 About this manual

Read this manual carefully in its entirety.

It contains important information about the installation and operation of the battery inverter. Pay particular attention to the instructions regarding safe usage. KOSTAL Solar Electric GmbH assumes no liability for damages arising from the non-observance of this manual.

This manual is an integral part of the product. It applies exclusively to the battery inverters from KOSTAL Solar Electric GmbH. Keep this manual and give it to the new owner should you pass it onto a new operator.

The installer and the operator must have unrestricted access to these instructions at all times. The installer must be familiar with this manual and follow all instructions.

The most recent version of the operating manual for your product is available in the download area at www.kostal-solar-electric.com.

Target group

This manual is intended for trained and qualified electrical technicians who are entrusted with installing, maintaining and repairing the battery inverter.

The battery inverters described in this manual differ from one another in terms of particular technical details. Information and handling instructions that only apply to certain device types, are to be identified accordingly.

Information concerning your safety or that of the unit is specifically noted.

Navigation through the document

In order to enable navigation through this document, it contains clickable areas.

One of these is the navigation bar in the header of each page. By clicking here, you are taken to the overview pages of the individual chapters.

The table of contents can also be used in this way: From the index at the beginning of each chapter you can go to the indicated sub-chapter in one click.

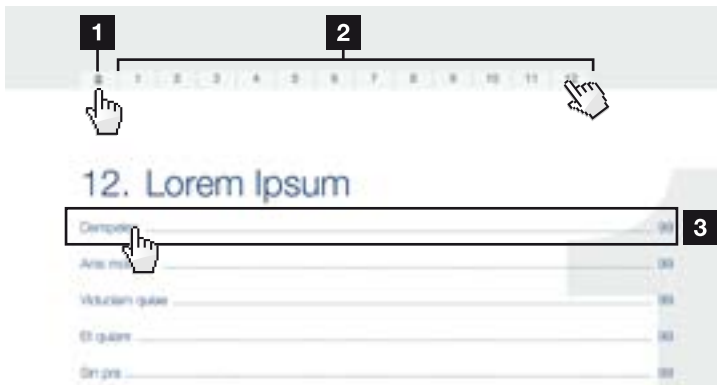

Fig. 1: Navigation through the document

- 1** Calling up the main table of contents
- 2** Navigation bar
- 3** Tables of contents

You can navigate to the referenced points in the document within the instruction text using the cross-references.

🔗 Ch. 1

🔗 Fig. 1, It. 2

Fig. 2: Examples of cross-references

1.4 Notes in this manual

Installation ⚠️

Install a line circuit breaker into the mains cable between the inverter and the feed meter to secure it against overcurrent.

In countries in which a second PE connection is prescribed, connect this at the marked place on the housing.

Connecting AC-side ⚠️

Connect the wires of the mains cable to the AC terminal in accordance with the labelling.

For connection with a computer or with a computer network. Connect several inverters to a network for data retrieval. ⓘ

2 ⚠️ **DANGER**
Risk of death due to electrical shock and discharge!
De-energise the device, secure it against being restarted and wait five minutes so that the capacitors can discharge.

3 ⓘ **IMPORTANT NOTE**
To connect the AC cables, the inverter is equipped with spring-loaded terminal strips.

4 ⓘ **INFO**
For connection with a computer, an Ethernet cable of category 6 is to be used.

Fig. 3: Safety instructions in this manual

- 1** Reference icon within the instruction text
- 2** Warning
- 3** Information note
- 4** Other notes

Notes have been incorporated into the instruction text. A differentiation is made in this manual between warnings and information notes. All notes are identified in the text line with an icon.

Warnings

The warnings refer to life-threatening dangers. Serious injuries possibly resulting in death may occur.

Each warning consists of the following elements:

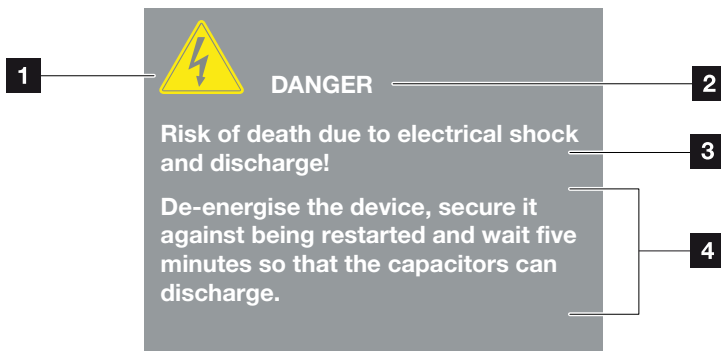

Fig. 4: Structure of the warnings

- 1** Warning symbol
- 2** Signal word
- 3** Type of danger
- 4** Corrective actions

Warning symbols



Danger



Danger due to electrical shock and discharge



Danger due to burns

Signal words

Signal words are used to identify the severity of the danger.

DANGER

Indicates a direct hazard with a high level of risk, which, when it is not avoided, may result in death or serious injury.

WARNING

Indicates a hazard with a moderate level of risk, which, when it is not avoided, may result in death or serious injury.

CAUTION

Indicates a hazard with a low level of risk, which, when it is not avoided, may result in minor or slight injury or property damage.

Information notes

Information notes contain important instructions for the installation and trouble-free operation of the battery inverter. These must be followed at all times. The information notes also point out that failure to observe can result in damage to property or financial damages.

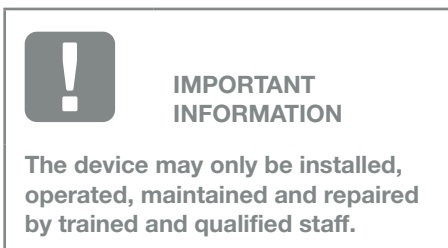

Fig. 5: Example of an information note

Symbols within the information notes



Important information



Damage to property possible

Other notes

They contain additional information or tips.



INFO

This is additional information.

Fig. 6: Example of an information note

Symbols within the additional notes



Information or tip



Enlarged view

1.5 Symbols used

Symbol	Meaning
1., 2., 3. ...	Sequential steps in a handling instruction
→	Effect of a handling instruction
✓	Final result of a handling instruction
☞	Cross-reference to other places in the document or to other documents
■	List

Tab. 1: Symbols and icons used







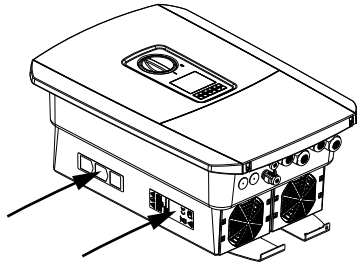

Abbreviations used

Abbrevia- tion	Explanation
Tab.	Table
Fig.	Figure
It.	Item
Ch.	Chapter

1.6 Labels on the device



Signs and labels are attached to the housing of the battery inverter. These signs and labels may not be altered or removed.

Symbol	Explanation
	Danger due to electrical shock and discharge
	Danger due to burns
	Danger notice
	Danger due to electrical shock and discharge. Wait five minutes (discharge time of the capacitors) after shut-down
	Additional earth connection
	Observe and read operating manual
	Device may not be disposed of with household waste. Observe the local application of disposal requirements
	CE marking The product satisfies the applicable EU requirements

2. Device and system description

2.1	System overview	21
2.2	The battery inverter	22
2.3	Functions	28

2.1 System overview

Battery inverter with battery connection

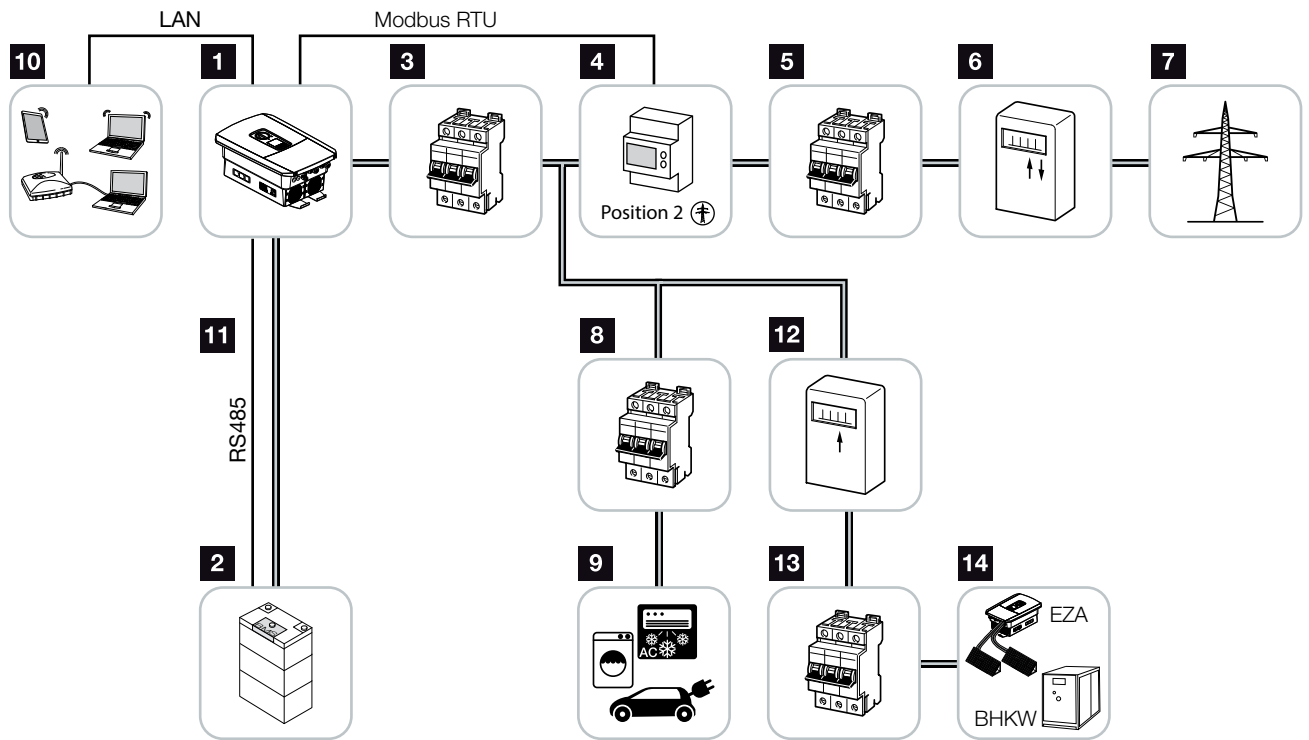

Fig. 7: Battery inverter with battery connection

- 1** battery inverter
- 2** Battery system connection
- 3** Line circuit breaker for battery inverter
- 4** KOSTAL Smart Energy Meter (Modbus RTU)
- 5** Main fuse building
- 6** Procurement and feed meter or smart meter (not in all countries)
- 7** Public grid
- 8** Line circuit breaker for power consumption
- 9** Power consumption
- 10** Communication connection for battery inverter
- 11** Communication connection for Battery Management System (BMS) via RS485
- 12** Feed meter for AC power source
- 13** Line circuit breaker for AC power source
- 14** AC power source, e.g. CHP plant or other generation plants, such as PV inverter (the energy from the AC power source can be temporarily stored in the battery)

2.2 The battery inverter

The battery inverter from outside

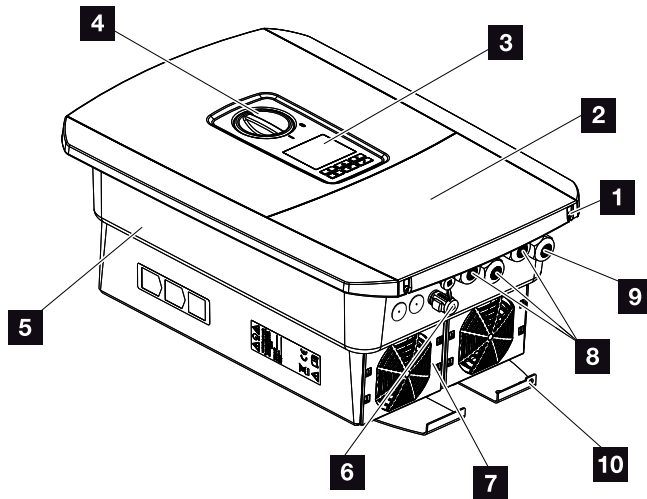

Fig. 8: Battery inverter (exterior view)

- 1 Cover screws
- 2 Cover (terminal compartment)
- 3 Display
- 4 DC switch
- 5 Housing
- 6 Plug connector for connecting the battery system
- 7 Fan
- 8 Cable openings for communication
- 9 Cable opening for mains cable
- 10 Additional PE connection, outside

DC switch on battery inverter

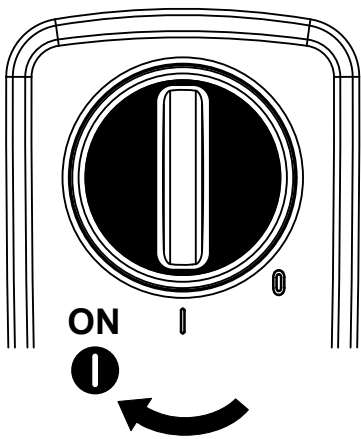

Fig. 9: DC switch ON

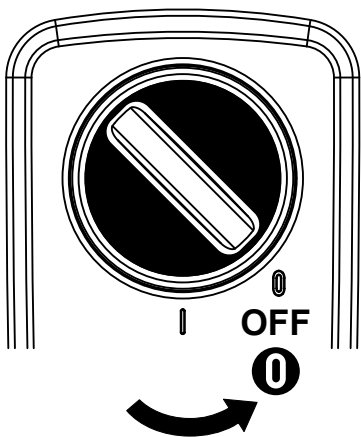

Fig. 10: DC switch OFF

The terminal compartment

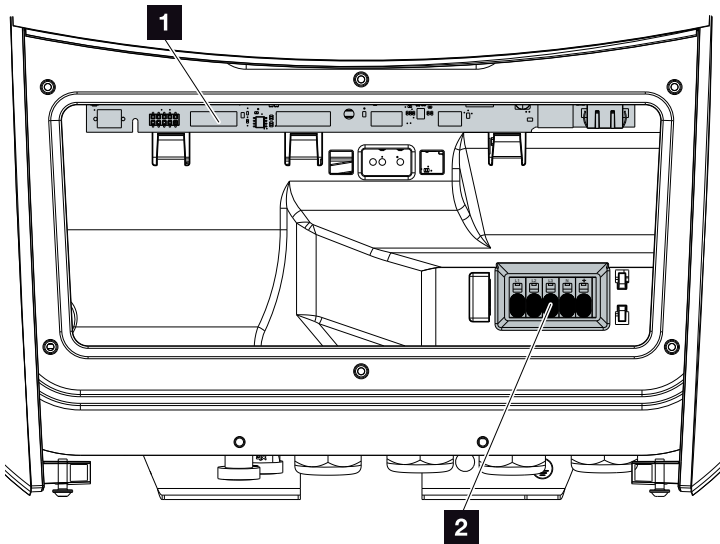
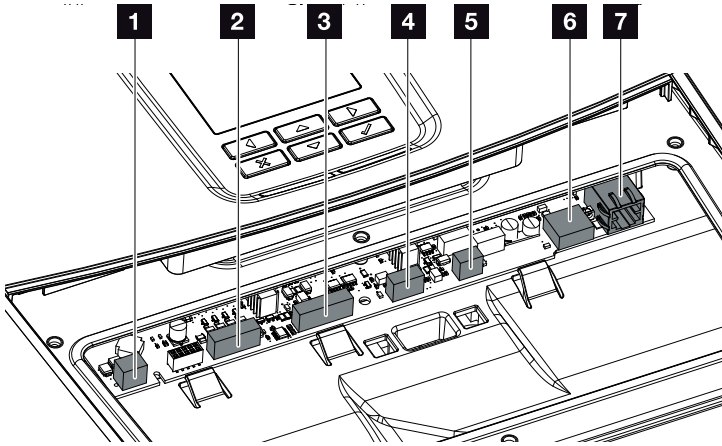

Fig. 11: Battery inverter (interior view)

- 1** Smart Communication Board (SCB)
- 2** AC terminal

Smart Communication Board (SCB)



Battery inverter (interior view)

- 1** Not used
- 2** Terminal for digital interface for ripple control receiver/
external battery control
- 3** Terminal for battery communication via RS485
- 4** Not used
- 5** Terminal for energy meter
(Modbus RTU)
- 6** USB 2.0 port
- 7** Ethernet connection (RJ45) LAN

The Smart Communication Board (SCB) is the battery inverter's communication hub. All the connections for communicating with other components can be found on the SCB.

The control panel

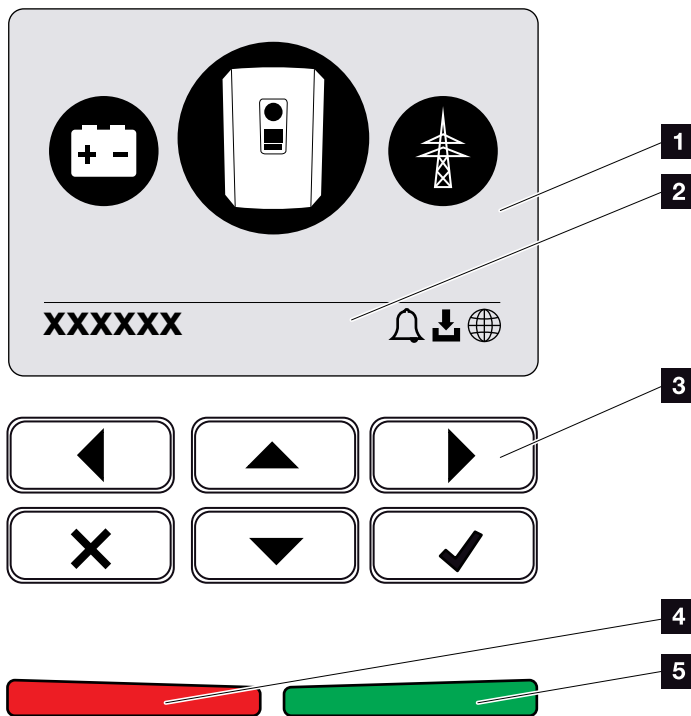





Fig. 12: Control panel

- 1** Display
- 2** Status line, alternating
(battery inverter status, event code, IP address, status of solar portal connection, updates available, events)
- 3** Control buttons
- 4** Red status LED for events
- 5** Green status LED for feed-in mode

Adjustments can be made and data retrieved via the control panel.

The battery inverter menus

The battery inverter provides the following menu items for querying statuses and configuring the battery inverter:

Symbol	Function
	Status query for AC feed-in power and grid parameters of public grid
	Battery power status query
	Battery inverter configuration

Tab. 2: Battery inverter menus



INFO

There may be deviations depending on the software version.

2.3 Functions

Energy management system

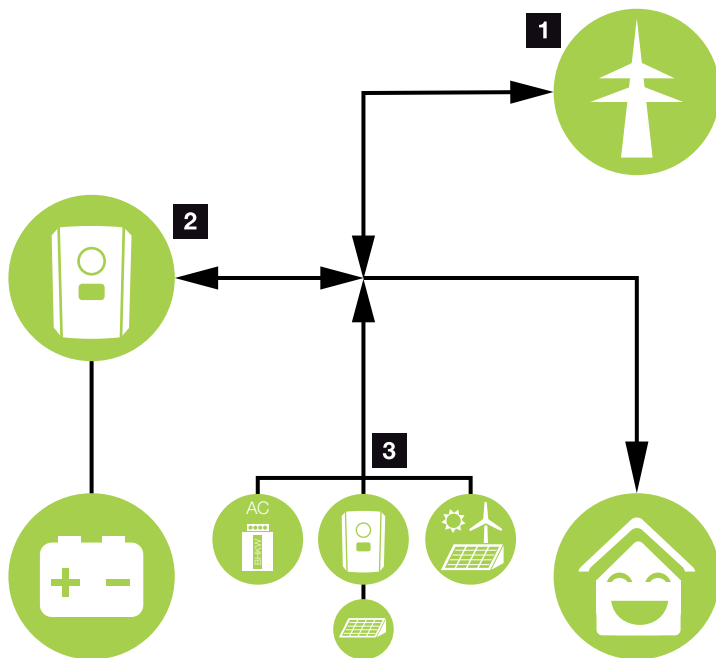

Fig. 13: Control and distribution of the energy flows

1 Grid energy:

- Energy supply for local consumers
- For charging the battery from the public grid, e.g. to protect the battery in winter or via external battery control/battery manager.

2 Battery energy:

- Energy supply for local consumers
- Feed-in to the public grid (only possible via external battery managers)

3 AC power sources:

- Energy supply for local consumers
- For charging the battery
- Feed-in to the public grid **i**

The Energy Management System (EMS) controls the distribution of energy between the DC side (battery) and the AC side (house grid, public grid). For this purpose, the EMS checks for consumption in the internal house grid. The logic of the EMS then calculates and controls the optimal usage of energy. The energy is primarily used for self-consumption.



INFO

AC power sources can be, for example, KOSTAL solar inverters, other inverters, combined heat and power units (CHP), small wind turbines or other energy sources in your own house grid.

Storing energy

The battery connected to the DC input of the battery inverter allows the AC energy generated in the house grid to be stored and retrieved later for self-consumption.

- Connection and battery usage at the DC input of the battery inverter is enabled at the factory.
- There is a list of approved KOSTAL Solar Electric GmbH battery storage systems on our homepage in the download area for the product.
- Various scenarios for the battery use strategy can also be selected on the Webserver, allowing the system to be matched to your requirements.

Communication

The battery inverter provides various interfaces for communication purposes. These establish a connection to other inverters, sensors, energy meters, batteries or a link to the Internet.

- LAN
LAN connects the battery inverter to the local home network via which it can then access the Internet and solar portal.
- RS485/Modbus (RTU)
An energy meter is connected to the Modbus interface and records the flow of energy within the house.

Secure communication

These days, secure data transfer is an important element of all devices linked to the Internet. All the data transferred externally from the battery inverter are of course encrypted for this reason.

- Security concept
Encrypted transfer of data to the solar portal
- Data encryption in line with AES and SSL standards

External battery control

The battery inverter has a charge/discharge management system that can be configured via the Webserver under the "Battery Settings" service menu. Among other things, the external battery control can be activated here, which then implements the specifications of your energy supplier or other service provider, for example.

Via the external battery management, the external supplier has access to the charge/discharge management of the battery inverter and can control it in such a way that the battery energy can be used e.g. for home consumption or that the battery energy is fed into the public grid in order to use it e.g. for grid stabilisation (load peaks in the grid (peak shaving)) or to provide grid services (primary control power). 



INFO

The system installer is responsible for the correct selection and installation of the meter structure in the house grid. The specifications of the energy supplier must be observed in this case.

The Webserver

The Webserver is the graphic interface for how information is displayed in the browser (e.g. Firefox, Internet Explorer or Google Chrome) for querying and configuring the battery inverter.

The Webserver provides the following functions:

- Login to the battery inverter
- Query the battery inverter status
- Current consumption values
- Current values of grid connection (e.g. charging, discharging)
- Statistics
- Display of log data
- Display of battery inverter version status (e.g. UI, FW, HW)
- Configure the battery inverter (e.g. software update, releasing options, battery configuration, making battery inverter settings which have been specified by the energy provider etc.)

For more information  **Ch. 6**

The data logger

A data logger is integrated in the battery inverter. The data logger is a data storage system, which collects and stores the yield data and performance data of the battery inverter and the storage system. Yield data (saving interval) is saved every 5 minutes. 

Saving interval	Saving time
5 minutes	Max. 365 days

Tab. 3: Saving intervals of data logger

For more information  **Ch. 7.**



INFO

Once the storage time has elapsed, the oldest data is always deleted.

For long-term backup, the data must be backed up with a PC or sent to a solar portal.

KOSTAL Solar Portal

The KOSTAL Solar Portal protects your investment in a PV system against yield loss, e.g. through active e-mail alerts of events.

You can log into the KOSTAL Solar Portal for free at www.kostal-solar-portal.com.

Functions include:

- Worldwide online access to the portal
- Graphic representation of the power and yield data
- Visualisation of data and thus being made aware of how to optimise self-consumption
- Notification of events by e-mail
- Data export
- Sensor evaluation
- Display and proof of a potential active power reduction by the grid operator
- Storage of log data for long-term and reliable monitoring of your PV system
- Provision of system data for the KOSTAL Solar App

Additional information about this product is available on our website www.kostal-solar-electric.com under **Products > Tools and software > Monitoring**.

Event codes

Should an event or fault occur during operation, it is indicated on the battery inverter display and stored in the battery inverter and solar portal (only if connected).

For more information  **Ch. 9.5.**

Service concept

The battery inverter includes smart monitoring. Should an event occur during operation, an event code for this is shown in the display.

As the operator of the system, in the event of a service call-out, you can then read out the message and obtain assistance from your installer or service partner.

For more information  **Ch. 7.4.**

KOSTAL Solar Plan configuration software

Our free KOSTAL Solar Plan software simplifies the inverter layout process.

Just enter the system data and individual customer data and receive a recommendation for a KOSTAL solar inverter tailored to the planned solar system. All KOSTAL solar inverters are considered for this. The customer's power consumption is also considered and, using standard load profiles, the potential for self-consumption and self-sufficiency is indicated.

The KOSTAL Solar Plan covers the following areas of inverter layout:

- Rapid layout
Manual inverter layout taking account of the inverter specifications
- Layout
Automatic inverter layout with the option of taking power consumption into account
- Storage layout
Automatic battery inverter layout with the option of taking power consumption into account

Alongside enhanced inverter layout, KOSTAL Solar Plan also helps you to produce quotations. Customer, project and installer data is added to the technical data entered by the user, then included with the quotation as a PDF overview. What's more, the planning data can also be saved in a project file and edited if required.

Additional information about this product is available on our website www.kostal-solar-electric.com under **Products > Tools and software > KOSTAL Solar Plan**.

3. Installation

3.1	Transport and storage	38
3.2	Scope of delivery	39
3.3	Installation	40
3.4	Electrical connection	43
3.5	Overview of Smart Communication Board (SCB)	47
3.6	Connecting energy meter	48
3.7	Communication connection	50
3.8	Connecting battery	53
3.9	Closing battery inverter	56
3.10	Connecting battery's DC cables	57
3.11	Initial commissioning	59
3.12	Configuring settings in the Webserver	63

3.1 Transport and storage

The function of the battery inverter has been tested, and it has been carefully packaged prior to delivery. Upon receipt, check the delivery for completeness and any transport damage. 📦

Complaints and damage claims are to be directly addressed to the shipping company.

If stored for a longer period before installation, all battery inverter components must be kept dry and dust-free in the original packaging.

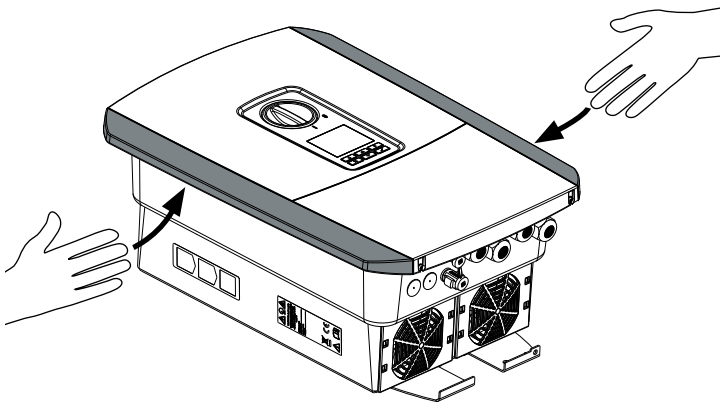

Fig. 14: Lateral grip for battery inverter

For enhanced battery inverter transport, use the grip strips on the left and right side of the battery inverter.



DAMAGE POSSIBLE

Potential risk of damage when placing the battery inverter down. Whenever possible, place the battery inverter on its back after unpacking.

3.2 Scope of delivery

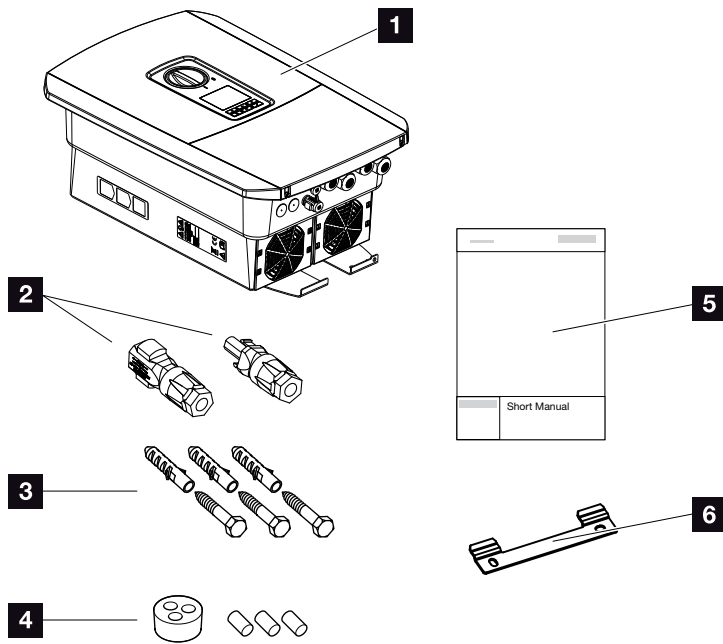

Fig. 15: Scope of delivery

The packaging contains:

- 1** battery inverter
- 2** DC plug connector
(each DC input: 1× plug, 1× socket)
- 3** 3 x screws 6x45 with S8 screw anchors
- 4** Plug seals for screw connection of network cable
- 5** Short manual
- 6** Wall mount

3.3 Installation

Selecting the installation site



Do not install the battery inverter outdoors.

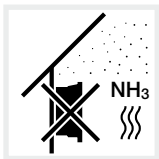

Protect the battery inverter from dust, contamination and ammonia gases. Rooms and areas containing livestock are not permitted as installation sites.



Mount the battery inverter indoors only.



The ambient temperature must be between -20 °C and +60 °C.

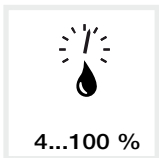

The air humidity must be between 4 % and 100 % (condensing).

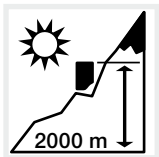

The battery inverter may only be installed up to an altitude of 2000 m.



A sufficient safety distance from flammable materials and potentially explosive areas in the vicinity must be ensured.





IMPORTANT INFORMATION

Observe these instructions when selecting the installation site. Guarantee claims may be restricted or become entirely null and void in the event of failure to observe.

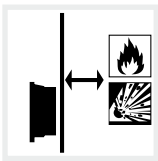

Mount the battery inverter on a stable installation surface that can safely bear the weight. Plasterboard walls and wood planking are not permitted.



Mount the battery inverter on a non-flammable installation surface. 

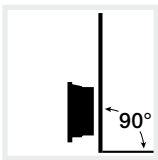

Mount the battery inverter on a vertical mounting surface.

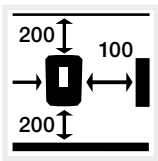

Maintain minimum distances and the necessary clearance.



Battery inverters may produce noise during operation. Install the battery inverter in such a way that people cannot be disturbed by operation noises.

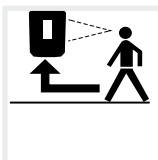

Battery inverters must be easily accessible and the display clearly legible.



Install the battery inverter out of reach of children.

Wall mounting ! !

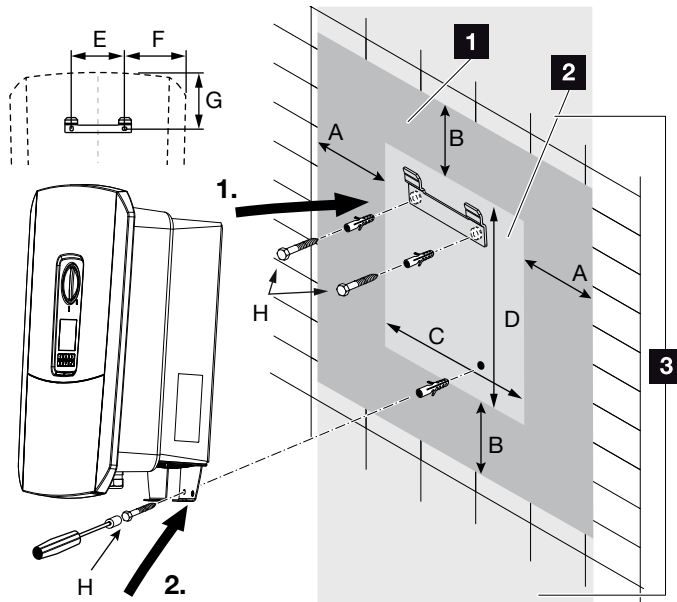

Fig. 16: Wall mounting with wall mount

- 1** Clearance
- 2** External dimensions of the battery inverter
- 3** Battery inverters may not be installed in this area

You can find the distances for wall mounting in the following table:

Dimensions in mm (inch)							
A	B	C	D	E	F	G	H
100	200	405	563	122	141	128	min. DIN571
(3.9)	(7.9)	(15.94)	(22.17)	(4.8)	(5.55)	(5.04)	A2-70 6x45

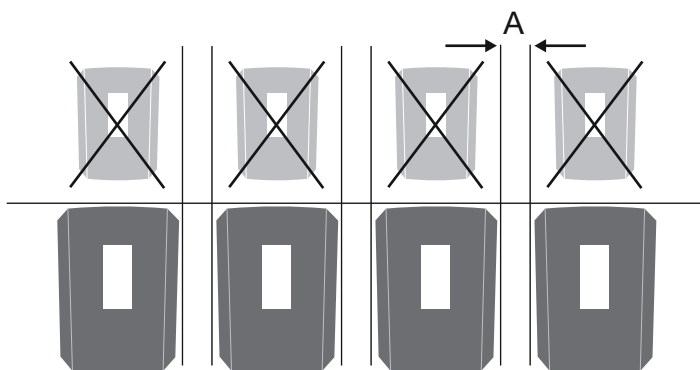

Fig. 17: Wall mounting of several battery inverters



IMPORTANT INFORMATION

Maintain the clearance around the battery inverter without fail so that it remains cool.



IMPORTANT INFORMATION

To install the battery inverter, use the wall mount with 2 securing bolts (included in scope of delivery) suitable for the existing base.

Fix the battery inverter to the wall at the bottom using a 3rd bolt (included in scope of delivery).

3.4 Electrical connection

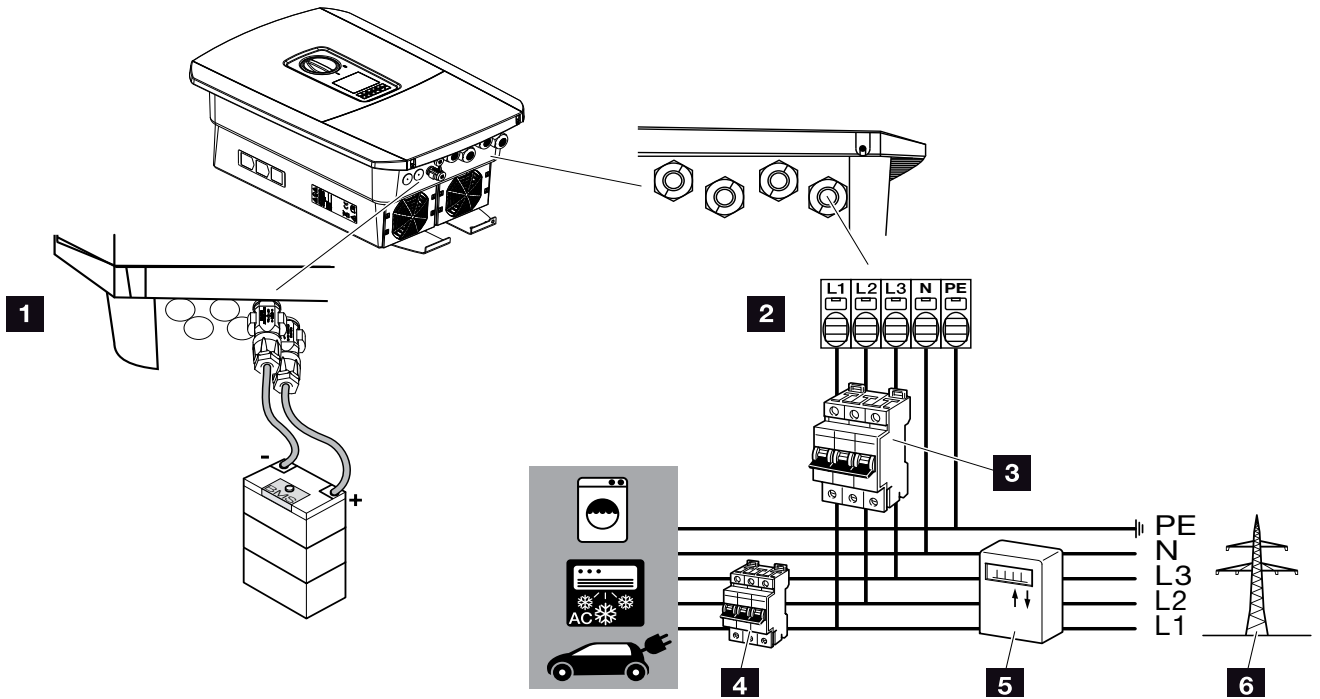

Fig. 18: Overview of electrical connections

Battery inverter connections

- 1 Battery connection
- 2 AC terminal !

External connections !

- 3 Line circuit breaker for battery inverter
- 4 Line circuit breaker for consumers
- 5 Energy meter
- 6 Public grid



IMPORTANT INFORMATION

Ensure that the phases of the AC terminal and the phases in the house grid are assigned uniformly.



IMPORTANT INFORMATION

A type A RCD ≥ 300 mA can be used on the AC side as residual current protection equipment (RCD). Compatibility with a type A RCD is set in the Webserver by going to Service menu > External hardware settings > Residual current protection equipment. (Default setting: compatible with type A RCD).

Connecting mains cable

1. De-energise the house grid. ⚠
2. Secure home fuses against reactivation.
3. Move DC switch on battery inverter to “Off” position.

➡ Fig. 10

4. Remove screws on bottom cover and take off cover. ⚠

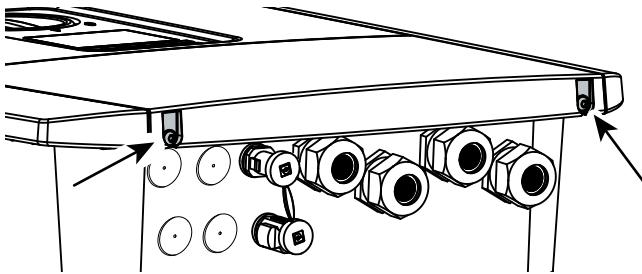

Fig. 19: Taking off cover

5. Remove screws of terminal compartment and take off cover.

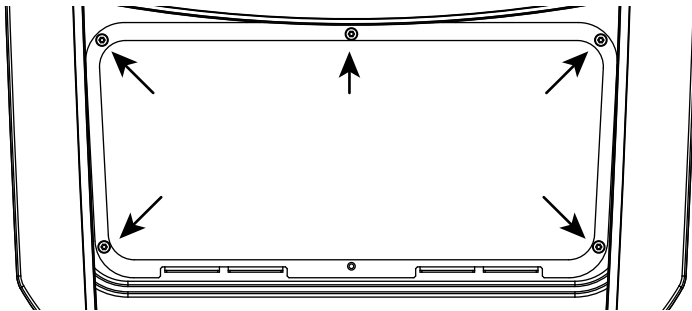

Fig. 20: Taking off terminal compartment cover



DANGER

RISK OF DEATH DUE TO ELECTRICAL SHOCK AND DISCHARGE!

De-energise all devices and secure them against being switched on again.



IMPORTANT INFORMATION

Whenever working inside the battery inverter, only ever use insulated tools to prevent short-circuits.

6. Correctly lay the mains cable from the power distributor to the battery inverter. **!**

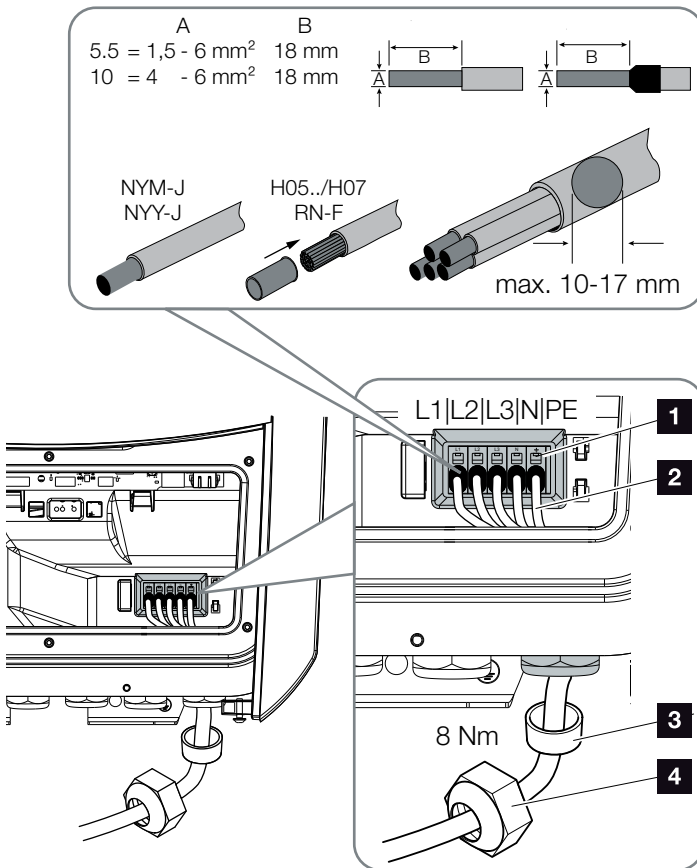

Fig. 21: Connecting the mains cable to the battery inverter

- 1** AC terminal
- 2** Mains cable
- 3** Sealing ring
- 4** Union nut

7. Insert mains cable into the battery inverter and seal with sealing ring and union nut. Tighten union nut to the prescribed torque. Torque: 8 Nm (M25).
8. When threaded connections are not used, leave the sealing ring in the threaded connections.



IMPORTANT INFORMATION

See the "Technical Data" chapter for the dimensioning of the required AC line circuit breaker. **!** Ch. 10.1

Single-wire cables (type NYY-J or NYM-J) without core end sleeves can be used with the AC terminal.

When using cables with fine wires (type H05../H07RN-F), core end sleeves should be used. Ensure that there is a contact surface of 18 mm.

9. Connect the wires of the mains cable to the AC terminal in accordance with the labelling.

!  Fig. 21, It. 1

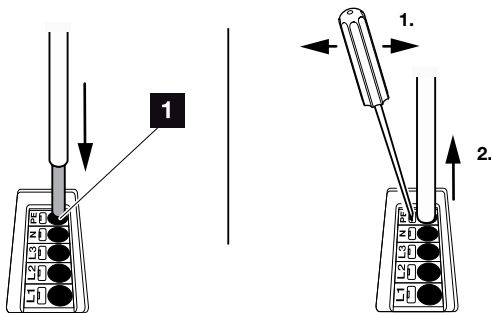



Fig. 22: Spring-loaded terminal strip

10. Install a line circuit breaker into the mains cable between the battery inverter and feed meter to protect it against overcurrent.  !
11. In countries in which a second PE connection is prescribed, connect this at the marked place on the housing (outside).

 Fig. 23, It. 1

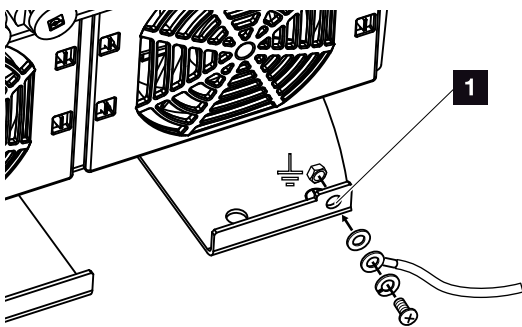

Fig. 23: Country-specific PE connection, outside

- ✓ The AC connection is connected.



IMPORTANT INFORMATION

To connect the AC cables, the battery inverter is equipped with spring-loaded terminal strips. The wires should be inserted into the large round openings (It. 1) of the terminal. The wire stripping length is 18 mm. Core end sleeves should be used with stranded cables.



WARNING

RISK OF FIRE DUE TO OVER-CURRENT AND HEATING OF THE MAINS CABLE!

Install line circuit breaker to secure against overcurrent.



IMPORTANT INFORMATION

This product may generate a direct current in the outer protective earthing conductor. A type A or B RCD ≥ 300 mA can be used on the AC side as residual current protection equipment (RCD). Use of a type A RCD is approved in the Webserver by going to Service menu > External hardware settings > Residual current protection equipment. (Default setting: type A RCD released).

3.5 Overview of Smart Communication Board (SCB)

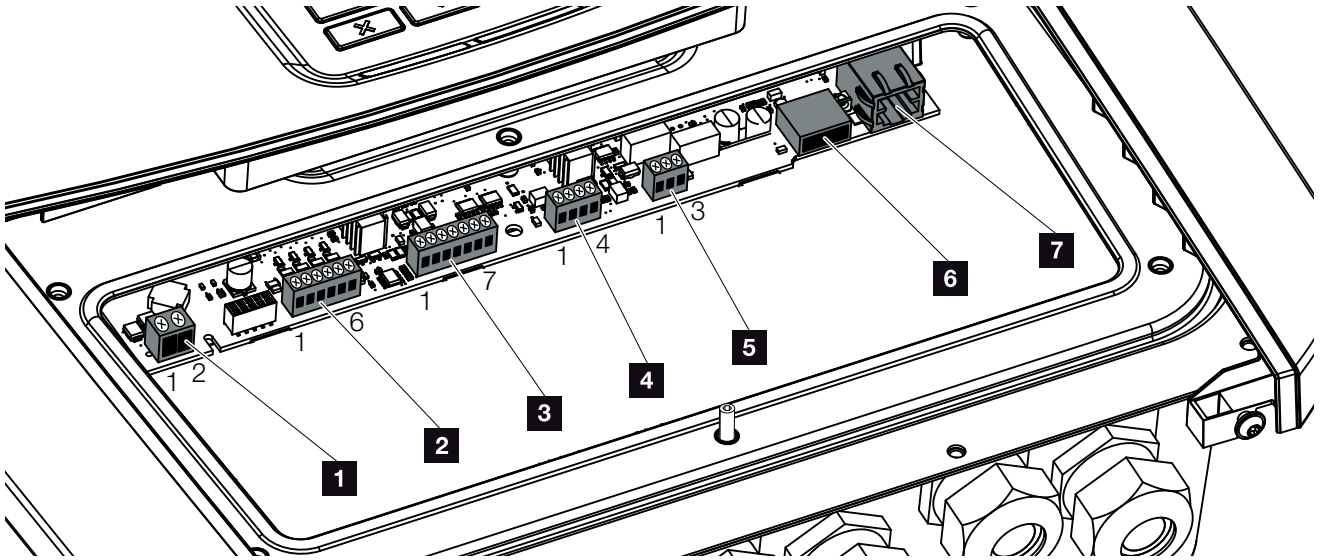

Fig. 24: Smart Communication Board - interfaces

Item	Designation	terminal	Pin	Explanation
1	Not used	X461	1 - 2	-
2	Terminal for digital connection for ripple control receiver or control box	X401	1	VDD (+12 to 14 V supply voltage)
			2	Input 1
			3	Input 2
			4	Input 3
			5	Input 4
			6	GND (0 V ground)
3	Terminal for communication with battery via RS485 or CAN	X601	1	VDD (+12 to 14 V supply voltage)
			2	CANopen High interface (data +)
			3	CANopen Low interface (data -)
			4	RS485 interface B (data -)
			5	RS485 interface A (data +)
			6	GND (0 V ground)
			7	not used
4	Not used	X602	1 - 4	-
5	Terminal for energy meter (Modbus RTU)	X452	1	Interface A (data +) RS485/Modbus RTU
			2	Interface B (data -) RS485/Modbus RTU
			3	GND
6	USB 2.0 interface	X171	1	USB 2.0 max. 500 mA (currently only for service)
7	Ethernet connection (RJ45)	X206	1	RJ45 max. 100 Mbit (LAN connection for linking e.g. to a router)

3.6 Connecting energy meter

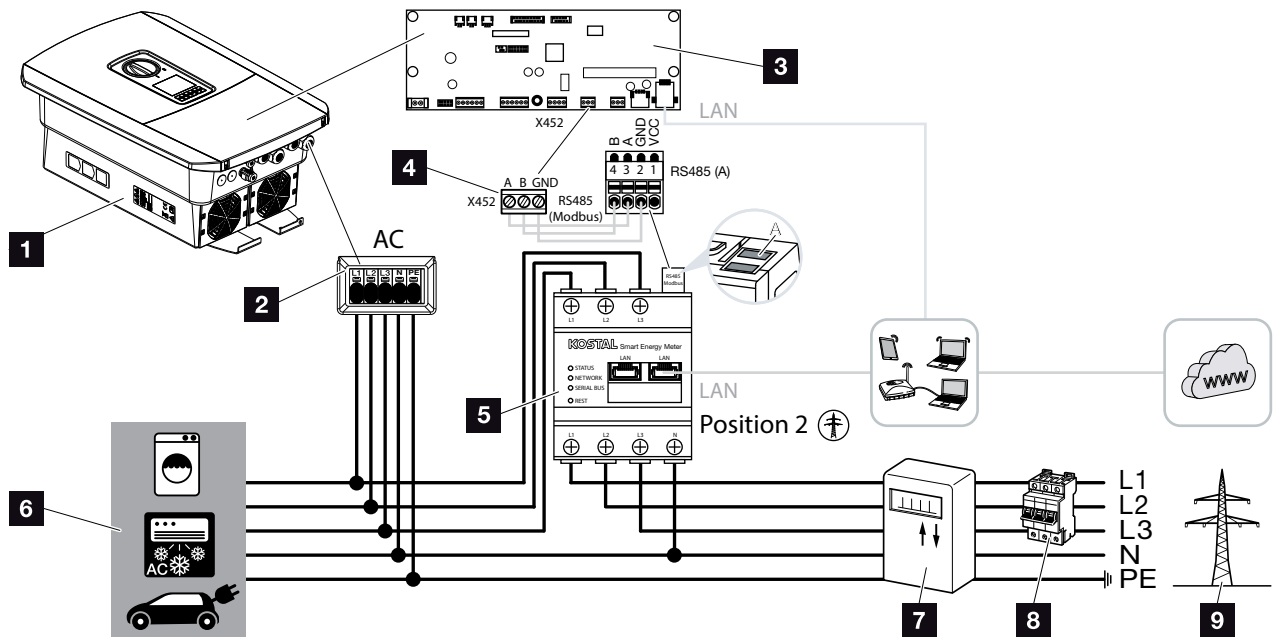



Fig. 25: Wiring diagram for energy meter - grid connection (position 2)

- 1 battery inverter
- 2 Battery inverter - AC terminal
- 3 Smart Communication Board
- 4 Terminal for energy meter
- 5 Digital energy meter (Modbus RTU)
Grid connection - position 2
- 6 Consumer device
- 7 Purchase and feed meter or smart meter
- 8 Line fuse for house
- 9 Public grid

The energy meter is installed on a top-hat rail in the meter box or the main distributor.

The energy meter must be installed at the grid connection point (position 2) in the house grid. The installation position is queried and set in the installation wizard or can be set in the Webserver. 



IMPORTANT INFORMATION

Only energy meters which have been approved for the battery inverter by KOSTAL Solar Electric may be used.

You will find an up-to-date list of the approved energy meters on our homepage in the download area for the product.

The following energy meters are currently approved:

- KOSTAL Smart Energy Meter

1. De-energise the house grid. ⚠
2. Fit the energy meter on the top-hat rail in the control cabinet or power distributor.
3. Correctly route the communication cable from the battery inverter to the control cabinet and connect to energy meter following wiring diagram provided by manufacturer. ⓘ
4. Connect communication cable in battery inverter to terminal for energy meter (torque: 0.2 Nm).

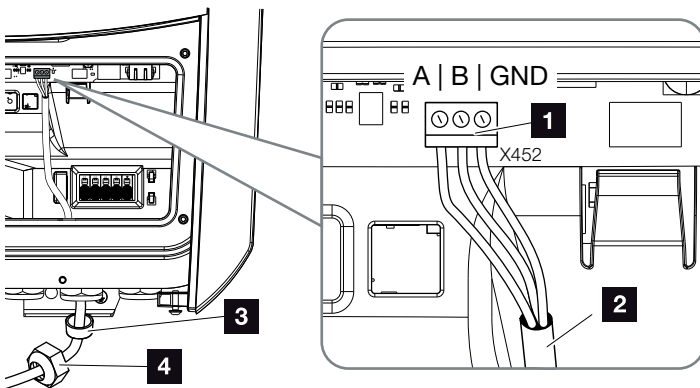

Fig. 26: Connection for digital energy meter (Modbus RTU)

- 1 Terminal for energy meter (Modbus RTU)
- 2 Communication cable to energy meter
- 3 Sealing ring
- 4 Union nut

✓ The energy meter is connected.

The type of energy meter used is selected when the battery inverter is first installed or can be set using the battery inverter menu or Webserver.



DANGER

RISK OF DEATH DUE TO ELECTRICAL SHOCK AND DISCHARGE!

De-energise all devices and secure them against being switched on again.



INFO

The communication cable is subject to the following requirements:

- Wire cross-section of
0.34 - 1.5 mm² (rigid)
0.34 - 1.0 mm² (flexible)
- Max. length 30 m.
- Length of stripped insulation 4.5-5.5 mm.

3.7 Communication connection

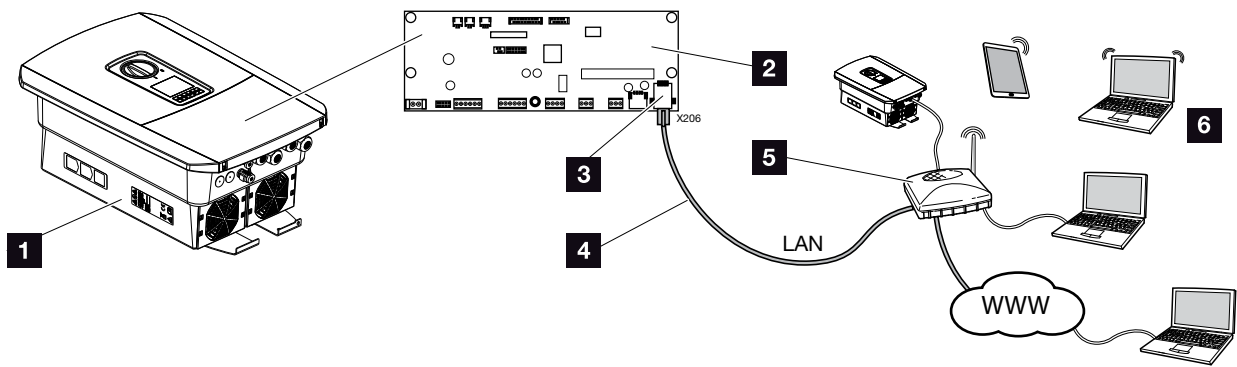

Fig. 27: Communication connection

- 1** Battery inverter
- 2** Smart Communication Board
- 3** RJ45 connection socket (Ethernet/LAN)
- 4** LAN cable
- 5** Router
- 6** Computer / router / tablet / KOSTAL solar inverter (for configuration or data retrieval)

The Smart Communication Board is the battery inverter's communication hub. To this end, computers, routers, switches and/or hubs can be connected to the RJ45 connection.

If the Ethernet cable is connected to a router, the battery inverter is integrated into your own network and can be contacted by all computers or KOSTAL solar inverters incorporated into the same network.

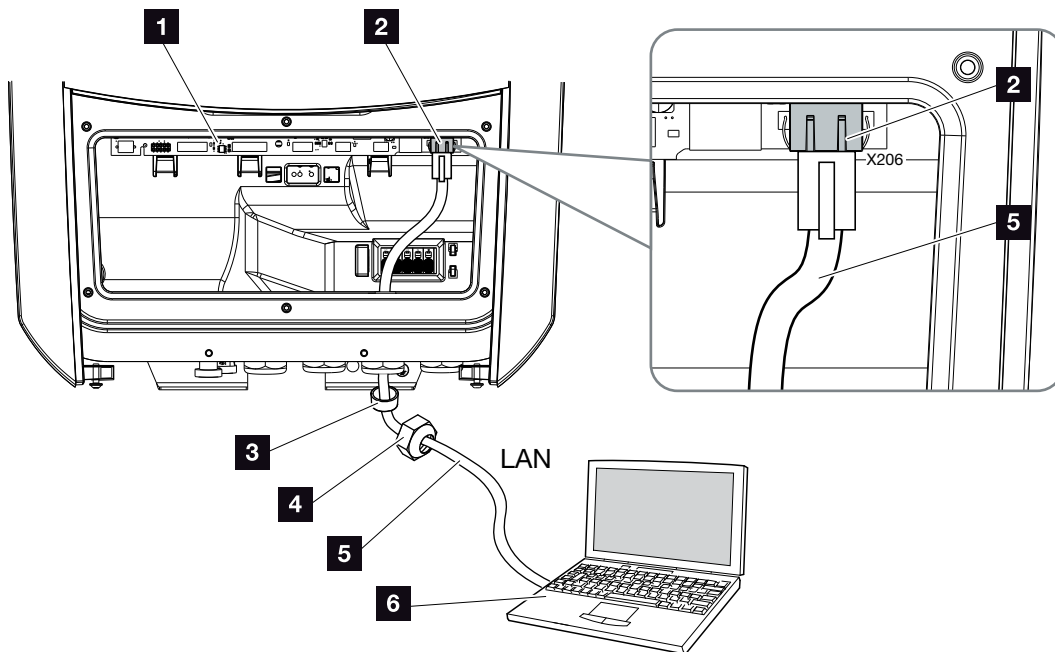





Fig. 28: Connecting battery inverter and computer with an Ethernet cable

- 1 Smart Communication Board
- 2 LAN connection (RJ45 Ethernet)
- 3 Sealing ring
- 4 Union nut
- 5 Ethernet cable (Cat 6)
- 6 Computer (for configuration or data retrieval)

1. De-energise the battery inverter's terminal compartment.  **Ch. 4.3**
2. Insert Ethernet cable into battery inverter and seal with sealing ring and union nut. Tighten union nut to the prescribed torque. Torque: 8 Nm (M25). 
3. Connect Ethernet cable to LAN interface of Smart Communication Board.
 **Fig. 28 It. 2**



DANGER

RISK OF DEATH DUE TO ELECTRICAL SHOCK AND DISCHARGE!

De-energise device and secure against being switched on again.

 **Ch. 4.3**



INFO

For connection with a computer or computer network (Ethernet 10BaseT, 10/100 MBit/s), an Ethernet cable of category 6 (Cat 6, FTP) with a max. length of 100m is to be used.

4. Connect the Ethernet cable to the computer or router.
- ✓ The battery inverter is connected to your own network.

3.8 Connecting battery

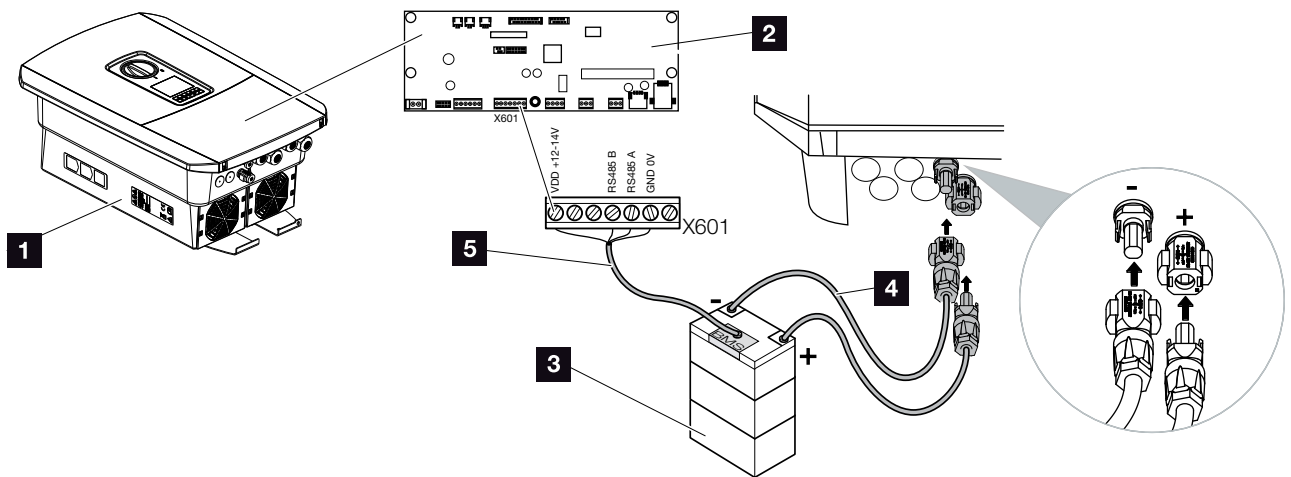

Fig. 29: Battery storage connection

- 1 PLENTICORE BI battery inverter
- 2 Smart Communication Board
- 3 Battery storage with battery management system
- 4 DC cables for battery storage
- 5 Communication cable to battery storage

The battery storage is connected to the DC input of the PLENTICORE BI battery inverter. The DC input does not have to be activated here like PLENTICORE plus.

Note that

- only battery storage systems (manufacturers) which have been approved by KOSTAL Solar Electric GmbH may be connected to the battery inverter. **i**



INFO

A list of approved battery storage systems is available in the download area for the product on our homepage at www.kostal-solar-electric.com

Battery communication connection

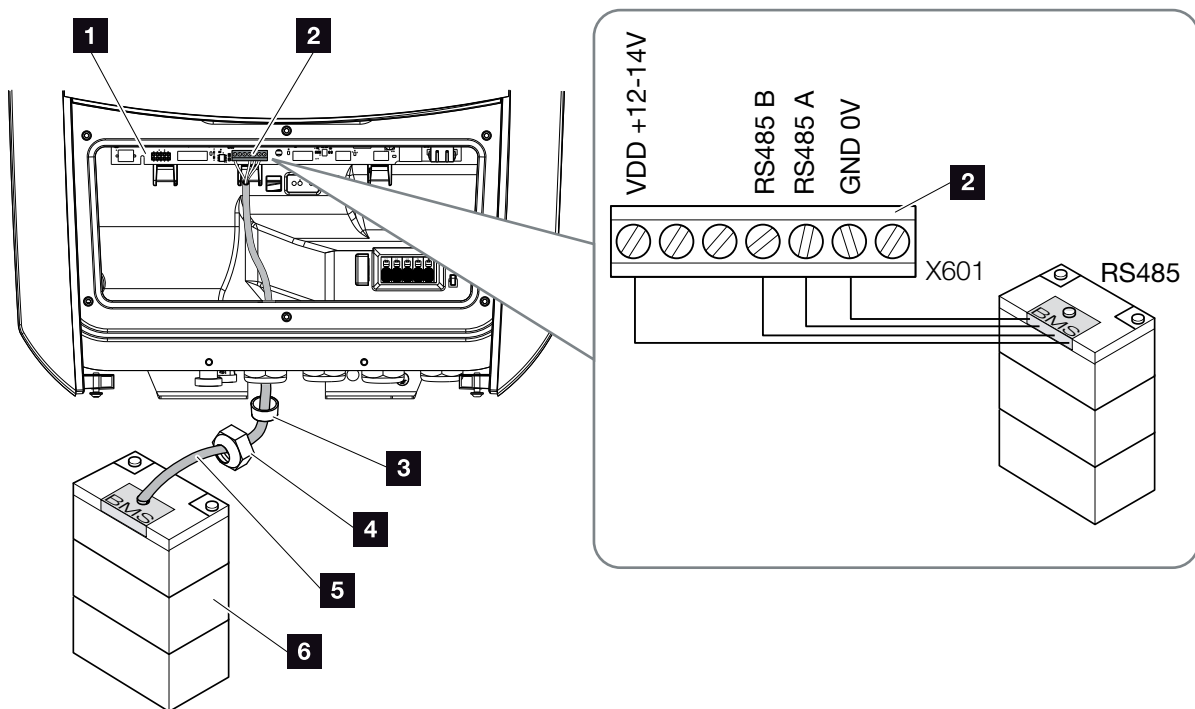

Fig. 30: Battery connection for RS485 communication

- 1** Smart Communication Board
- 2** Terminal for battery storage's communication cable
- 3** Sealing ring
- 4** Union nut
- 5** Control line
- 6** Battery storage



1. The communication cable may only be connected to the battery inverter if the terminal compartment of the battery inverter and battery storage are voltage-free. Disconnect the battery inverter and battery storage from the power supply. ⚡



DANGER

RISK OF DEATH DUE TO ELECTRICAL SHOCK AND DISCHARGE!

Disconnect the battery inverter and battery storage from the power supply. Please also observe the instructions in the operating manual provided by the battery manufacturer.

2. Insert communication cable of battery storage into the battery inverter and seal with sealing ring and union nut. Tighten union nut to the prescribed torque. Torque: 8 Nm (M25). 
 3. Connect communication cable (RS485) to communication interface of Smart Communication Board.
 **Fig. 30 It. 2**
 4. In the battery storage system, connect the communication cable to the battery management system. To do this, consult the operating manual provided by the battery manufacturer. 
- ✓ The communication cable has been connected.



INFO

The communication cable is subject to at least the following requirements. Please consult the manual provided by the battery manufacturer for more details.

- Wire cross-section
0.34 - 1.5 mm² (rigid)
0.34 - 1.0 mm² (flexible)
- Outer diameter 5-10 mm
- Max. length 30 m
- Length of stripped insulation
4.5-5.5 mm
- Twisted pair (e.g. Cat.5e or better)



INFO

To prevent communication errors between the battery and the battery inverter, both devices must be connected via an earth potential.

3.9 Closing battery inverter

1. Tighten all cable glands and check that they are properly sealed.
2. Check the fit of connected wires and strands in the battery inverter.
3. Remove any foreign objects (tools, wire cuttings, etc.) from the battery inverter.
4. Install the terminal compartment cover and screw it tight (2.0 Nm).
5. Fit cover onto battery inverter and screw it tight (1.5 Nm).

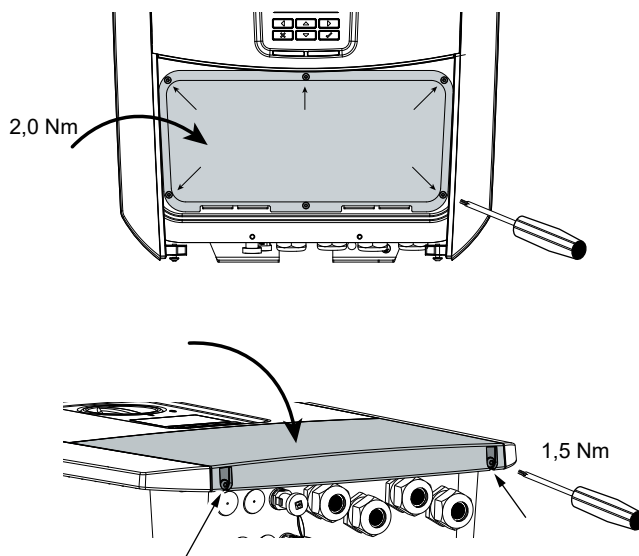

Fig. 31: Closing battery inverter

3.10 Connecting battery's DC cables

The battery's DC cables may only be connected to the battery inverter if the battery inverter and battery storage are voltage-free.

1. Disconnect battery storage and battery inverter from the power supply. ⚠️
2. Correctly fit the plug on the positive cable and the socket on the negative cable. The battery inverter is equipped with plug connectors from PHOENIX CONTACT (type Sunclix). During installation, always observe the most recent specifications from the manufacturer (e.g. permissible tightening torque etc.).¹
3. When mounting the sockets and plugs on the DC cables used by the battery, ensure their polarity is correct! ⚠️
4. Insert the sockets and plugs of the battery's DC cables into the battery inverter. Keep the plug seals out of the plug connectors.

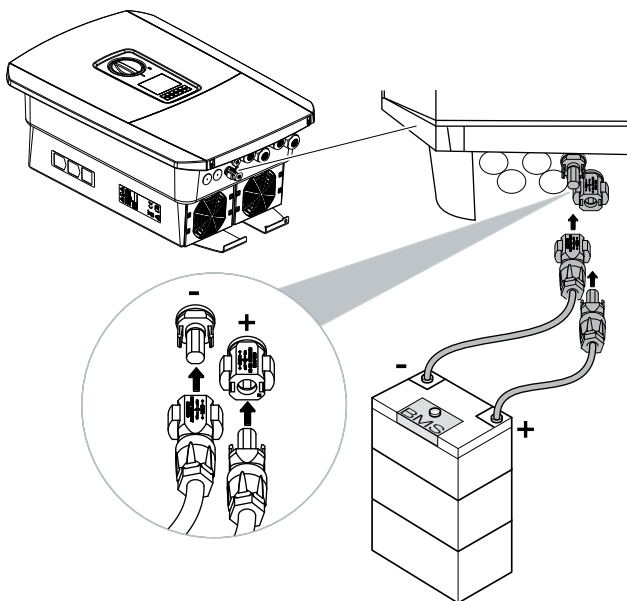

Fig. 32: Battery's DC connection



DANGER

RISK OF DEATH DUE TO ELECTRICAL SHOCK AND DISCHARGE!

The battery's DC cables may be energised. Be sure to de-energise the battery storage system. Please also observe the instructions in the operating manual provided by the battery manufacturer.

¹You can find information about the Sunclix installation specification at:
www.phoenixcontact.com







IMPORTANT INFORMATION

The cross-section of the DC cables should be as large as possible. We recommend using flexible, tin-plated cables with a cable cross-section of 6 mm². Please observe the specifications of the plug manufacturer and the technical data for the inverter.

5. Configuration and selection of battery type must take place after initial installation in the Webserver.
- ✓ The battery's DC cables are connected.

3.11 Initial commissioning

Procedure for initial commissioning

1. Activate supply voltage via the line circuit breaker.
2. Switch on battery storage via battery switch. 
- The battery storage starts up.
3. Switch the battery inverter's DC switch to ON.
 **Fig. 9**
- The installation wizard is shown on the display. 
4. Press the right arrow key to start the installation.
- The “Language” menu is displayed.
5. Select language and confirm.
To do so, use the arrow keys to select a language.
Confirm using “ENTER”.
6. Press the right arrow key to go to the next installation item.
- The “Date and time” menu is displayed.
7. Select time zone and set date/time or run automatic detection. Confirm using “ENTER”. 
8. Press the right arrow key to go to the next installation item.
- The “Energy management” menu is displayed.
9. Use the arrow keys to select the “Energy meter” field and press “ENTER”. Select the energy meter fitted from the list and confirm with “ENTER”. 



INFO

For more information about operation, refer to the operating manual for the battery storage system.



INFO

The installation process may vary depending upon the software version of the battery inverter.

Information about using the menu:

 **Ch. 4.4**



INFO

The entry of date/time ensures that the downloaded log data has the correct time assigned to it.



INFO

A list of approved energy meters and their purpose are available in the download area for the product on our homepage at

www.kostal-solar-electric.com

Currently approved energy meters:

- KOSTAL Smart Energy Meter (KSEM)

10. Use the arrow keys to select the “Sensor position” field and press “ENTER”. The grid connection position (position 2) for the installed energy meter is selected by default and does not need to be changed. 
11. Press the right arrow key to go to the next installation item.
 - The “Network IPv4” menu is displayed.
12. Press “ENTER” to activate the network protocol.
13. Enter the data relating to the network. This may be a fixed IP address for the battery inverter or the IP address may be obtained automatically via DHCP. Confirm the entries with “ENTER”.
14. Press the right arrow key to go to the next installation item.
 - The “Modbus SunSpec (TCP)” menu is displayed.
15. If you need the Modbus SunSpec protocol via TCP, e.g. for externally connected monitoring of the battery inverter, you can activate it here. To do this, press “ENTER” to activate the Modbus SunSpec protocol.
16. Press the right arrow key to go to the next installation item.
 - The “Solar portal” menu appears on the display.
17. Select the corresponding menu item with the arrow keys.
18. Press “ENTER” and select the solar portal used. Confirm the entries with “ENTER”.



INFO

It is absolutely essential that position 2 (grid connection) is selected for the energy meter.

19. To activate the transfer, highlight the item and confirm with the "ENTER" key.

→ The transfer is activated

20. Press the right arrow key to go to the next installation item.

→ The "Extra option" menu appears on the display.

If you currently do not want to activate any additional options, you can skip this item.

This item can be used to enable options by entering an activation code in the battery inverter. Functions that require an activation code can be purchased from our online shop. 

Select the "Release option" and confirm the input with the "ENTER" key.

Enter the code you obtained previously in the KOSTAL Solar online shop.

At the end, confirm the input with \checkmark .

21. Press the right arrow key to go to the next installation item.

→ The "Battery type" menu is displayed.

22. If there is a battery connected to the battery inverter, the connected battery type can be selected here.

Use the arrow keys to select the battery type.

Confirm the entries with "ENTER". 

23. Press the right arrow key to go to the next installation item.

→ The "Country/guideline" menu appears on the display.

24. Select country or guideline used. Confirm the entries with "ENTER".





INFO

The extra options currently released are shown under "Released options".



INFO

A list of approved battery storage systems is available in the download area for the product on our homepage at www.kostal-solar-electric.com

- 25.** Press the right arrow key to go to the next installation item.
- “Accept settings” appears on the display.
- 26.** Press “ENTER” to accept the input. 
- The settings are applied by the battery inverter.
- The battery inverter restarts after the installation.
- ✓ The battery inverter is in operation and can now be used. Initial commissioning is completed.  



INFO

If an incorrect country setting has been selected, it can be reassigned via the menu item "Reset country policy".



INFO

If there is an update available for the battery inverter, install this first.





INFO

In France, the installer is personally responsible for obtaining any additional prescribed labels that may be necessary and attaching them to the battery inverter and feed cables.

3.12 Configuring settings in the Webserver

After the initial installation, more settings can be configured using the battery inverter's menu or more conveniently via the Webserver.

To do this, use your PC or tablet to log into the Webserver as an installer.  **Ch. 6.1.** 

The following settings should be made after the initial commissioning:

- Battery inverter settings by the installer
- Prescribed settings for grid feed-in from energy supply company.
- Registration on the KOSTAL Solar Portal if this has not yet been done.
- With a battery connected, select the battery type and undertake battery configuration.
- Configure further settings, such as changing the password or updating the battery inverter software.



INFO



Parameters governed by the grid, limitations and guidelines can only be modified with a service code.

To log in as an installer, you need the master key from the battery inverter's type plate and your service code, which can be requested from our service team.  **Ch. 12.2**

4. Operation and operating the device

4.1	Switching on the battery inverter	65
4.2	Switching off the battery inverter	66
4.3	De-energise the battery inverter	67
4.4	Control panel	69
4.5	Operational status (display)	72
4.6	Operational status (LEDs)	75
4.7	The menu structure of the battery inverter	76

4.1 Switching on the battery inverter

1. Activate supply voltage via the line circuit breaker.
2. Switching on the battery storage via battery switch.

- The battery storage starts up.
3. Switch the DC switch on the battery inverter to ON.  **Fig. 9**
- The battery inverter starts up.
- During start-up, the LEDs in the control panel of the battery inverter light up briefly.
- The screensaver appears on the display and displays the device type. The screensaver is deactivated when a key is pressed twice. 
- ✓ The battery inverter is in operation.



INFO

For more information about operation, refer to the operating manual for the battery storage system.





INFO

If no key is pressed for several minutes, the screensaver with the image of the battery inverter appears automatically on the display.

4.2 Switching off the battery inverter

In order to switch off the battery inverter, carry out the following steps :

Additional steps are needed for repair work on the battery inverter.  **Ch. 4.3**

1. Turn the DC switch on the battery inverter to OFF.
 **Fig. 10**
 2. Switch off the battery storage. 
- ✓ The battery inverter is switched off. The battery inverter remains energised and monitoring is still performed.



INFO

A detailed description of how to switch off the battery storage is available in the operating manual provided by the battery manufacturer.

4.3 De-energise the battery inverter

When working in the terminal compartment

Before working in the battery inverter's terminal compartment, this area must be de-energised. ⚠

It is imperative that these steps are carried out:

1. Turn the DC switch on the battery inverter to OFF.

 **Fig. 10**

2. Switch off the AC line circuit breaker.
 3. Secure the entire voltage supply against being restarted.
- ✓ The terminal compartment of the battery inverter (high voltage) is now voltage-free. Work in the battery inverter's terminal compartment or on the AC line can now be carried out. ⚠



DANGER

RISK OF DEATH DUE TO ELECTRICAL SHOCK AND DISCHARGE!

De-energise device and secure against being switched on again.



DANGER

RISK OF DEATH DUE TO ELECTRICAL SHOCK AND DISCHARGE!

Further steps should be taken when working on the DC feed cables (battery). These steps can be found on the following page.

When working on the DC feed cables

When working on the DC feed cables, the battery inverter must be **completely** de-energised. ⚠

It is absolutely essential that these steps are taken in addition to those stated previously:

1. Switch off the connected battery storage systems. **i**
2. Disconnect all DC connections on the battery inverter. To do this, unlock the engaging clips with a screwdriver and disconnect the plug. ¹

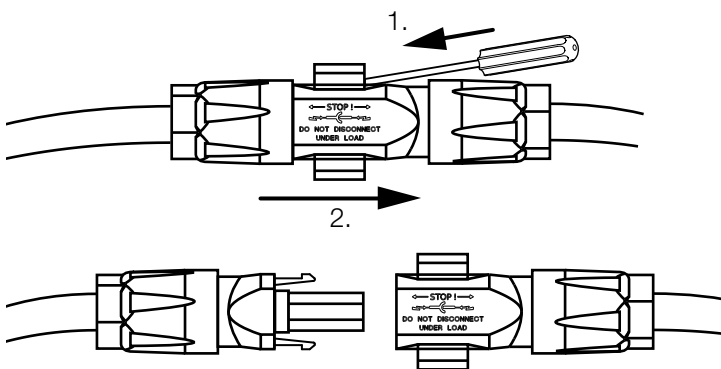

Fig. 33: Disconnecting SUNCLIX DC plug

3. Ensure that all connections are voltage-free.
- ✓ The battery inverter is now completely voltage-free. Work on the battery inverter or on the DC feed cables can now be carried out.



DANGER

RISK OF DEATH DUE TO ELECTRICAL SHOCK AND DISCHARGE!

De-energise all devices and secure them against being switched on again.



INFO

A detailed description of how to switch off the battery storage is available in the operating manual provided by the battery manufacturer.

¹Information about the Sunclix installation specification is available from:
www.phoenixcontact.com

4.4 Control panel

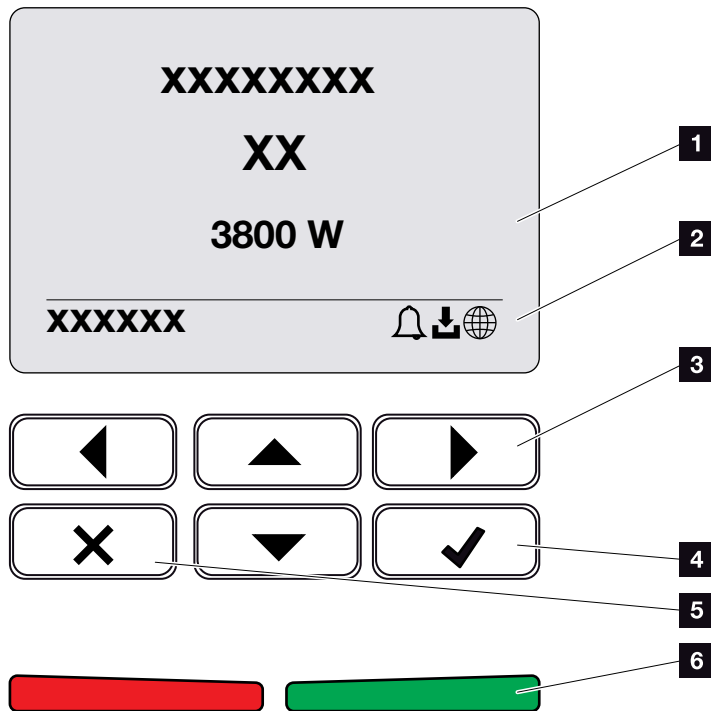

Fig. 34: Control panel

- 1 Display
- 2 Status display
- 3 Arrow key for navigating around the menus
- 4 "ENTER" key (for confirmation)
- 5 "DELETE" key (for clearing) or for exiting the menu
- 6 Status LED "Fault" (red), "Warning" (flashing red), "Feed-in" (green), "Feed in limited" (green flashing)

The battery inverter indicates the respective operational status by means of two LEDs and the display. **i**

The operating values can be retrieved and settings adjusted on the display.



INFO

If no key is pressed for several minutes, the screensaver with the image of the battery inverter appears automatically on the display.

Operation of the display

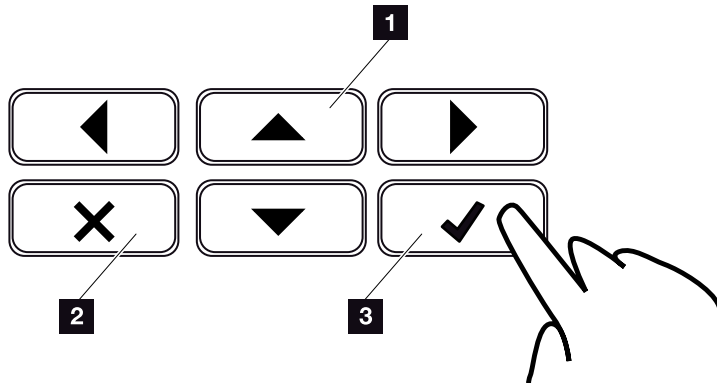

Fig. 35: Operation of the display

- 1 UP/DOWN / LEFT / RIGHT:** Characters, buttons, functions and input fields are selected with the arrow keys.
- 2 DELETE /Abort:** Pressing the “DELETE” key cancels the selection, input or value, aborts an input or jumps up a menu once the input has been confirmed.
- 3 ENTER / Confirm:** Pressing the "ENTER" key activates the selected menu element or confirms the input. Clicking in the “ENTER” input box saves the value.

Entry of text and numbers

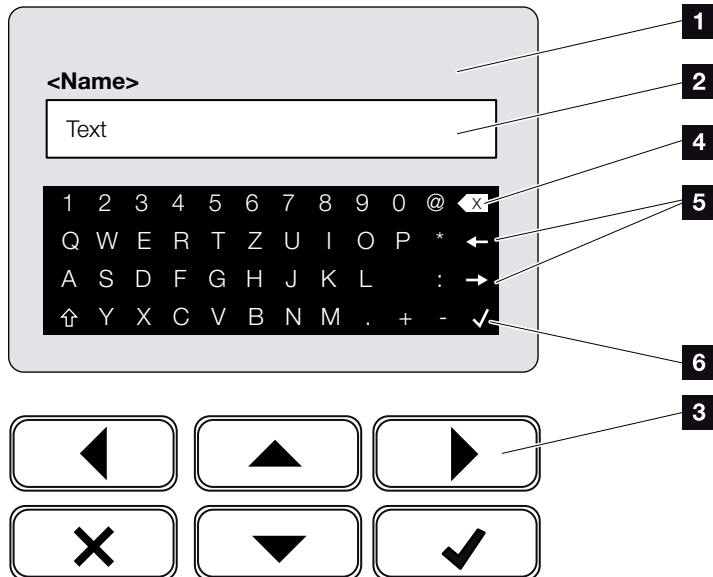

Fig. 36: Using keyboard to operate the display

- 1** Battery inverter display
- 2** Input box
- 3** Select character using the arrow keys, confirm with “ENTER” or exit the menu with “X”.
- 4** Individual characters to the left of the cursor can be deleted with the backspace key (<-).
- 5** The arrow keys can be used to move the cursor within the text.
- 6** The “Accept data” key is used to save the entry and close the menu.

The display can be used to enter texts and numbers (e.g. battery inverter name). When input is required, a keypad of letters and numbers appears under the input box in order to do this.

4.5 Operational status (display)

The operational statuses of the battery inverter are shown on the display of the battery inverter: **i**

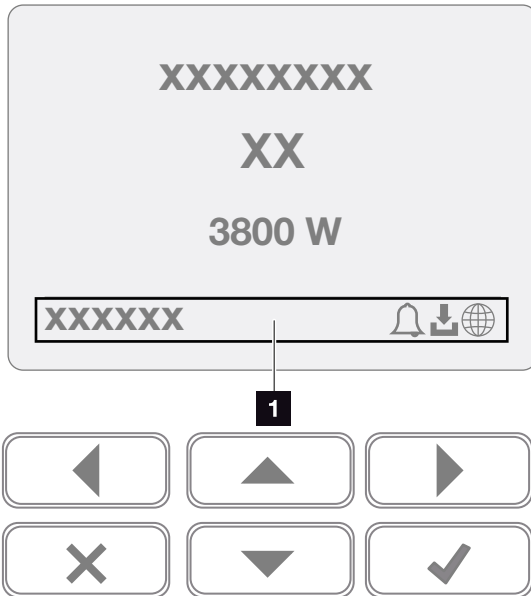

Fig. 37: "Operational status" display area

- 1** Display area that shows information and battery inverter status

The following table explains the operational notifications that can appear on the display:

Anzeige	Explanation
Off	Input voltage on the DC side (photovoltaic modules) is too low or the battery inverter is switched off.
Bell symbol	An event is present. Remedial measures can be found in the "Event codes" chapter Ch. 9.5 The event can be queried in the battery inverter menu by going to Service > Event list or can be called up using the "Down" arrow key.



INFO

The user interface/menu entries in the battery inverter depend on the installed inverter firmware (FW) and the user interface software (UI) in the battery inverter and may deviate from the description provided here.

Anzeige	Explanation
Download symbol	There is a software update available for the battery inverter. The update can be initiated in the battery inverter menu by going to Service > Updates or via the Webserver.
Globe symbol	Shows a successful connection to the solar portal.
IP address	The IP address of the battery inverter is displayed.
Insulation measurement	Device performs an internal check
Grid check	Device performs an internal check
Starting	Internal control measurements according to VDE 0126
Starting, including check of DC generators	Device performs an internal check
Feed in	Measurement successful
Feed-in ext. regulated	The feed-in is regulated due to a fault (e.g. excessive temperature, fault)
Shutdown by ext. signal	The feed-in is limited as a result of the energy supply company's external signal.
Event xxxx, yyyy	An event is present. Up to two active events can be displayed. Remedial measures can be found in the "Event codes" chapter  Ch. 9.5

Anzeige	Explanation
Waiting time ...	<p>The device is not feeding into the public grid as a result of an event.</p> <p>Grid synchronisation: The battery inverter synchronises itself with the public grid and then feeds into it.</p> <p>Grid check: a grid check is performed.</p> <p>Grid error: there is an error in the public grid. As soon as this is rectified, the battery inverter feeds into it again.</p> <p>Overheating: The battery inverter's temperature is too high. As soon as this has fallen, the battery inverter feeds into it again.</p>
DC voltage too low	Electronics are ready for operation, DC voltage is still too low for feed-in.
Impermissible DC voltage	DC voltage still too high.
Load	The battery connected to the battery inverter is charged.
Discharge	The battery connected to the battery inverter is discharged.
Equalisation charge	The battery which is connected to the battery inverter is charged from the public grid using an equalisation charge. This is only done in winter mode and must be activated in the Service menu.
Battery sleep mode	If insufficient energy for charging the battery is available for long periods, the battery is switched to sleep mode. This will protect the battery from total discharge. As soon as sufficient energy is available again, this mode is exited.

Tab. 4: Operating messages and symbols

4.6 Operational status (LEDs)

The LEDs on the front indicate the current operational status.

LEDs on battery inverter

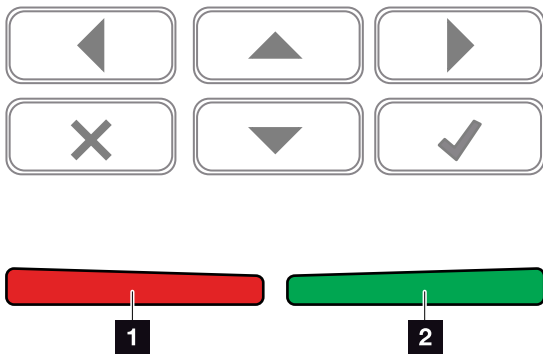

Fig. 38: LEDs on display of battery inverter

1 Red LED off:

There are no faults present

Red LED flashing:

There is an event (warning) active.

Red LED lit up:

A fault has occurred. Remedial measures can be found in the "Event codes" chapter [Ch. 9.5](#)

2 Green LED off:

Battery inverter does not feed in.

Green LED flashing:

Battery inverter feeds in with limitation.

Green LED lit up:

The green LED signals the feed-in mode of the battery inverter.

4.7 The menu structure of the battery inverter

The screensaver

After starting up or if no key has been pressed for a long time, the screensaver is displayed on the battery inverter.

Pressing any key activates the background lighting. The screensaver is exited by pressing any key.

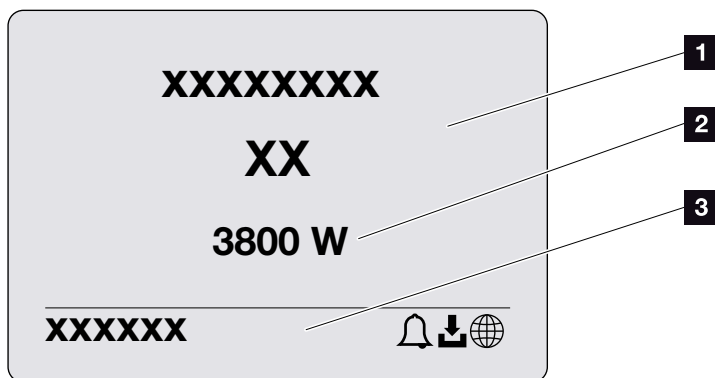

Fig. 39: Screensaver

- 1** Battery inverter type with power class
- 2** Current AC power
- 3** Status line, alternates every 5 seconds with:
 - IP address (if configured)
 - Battery inverter status
 - Event code (if available)
 - Solar portal connection active (if configured)

The power flow diagram

When the screensaver is being displayed, the power flow diagram can be displayed by pressing another key. The diagram is a very clear representation of the current power flow in the house grid and includes the relevant power values. The arrows indicate the direction in which power is flowing at present.

Pressing the “OK” key exits the power flow diagram and switches to the battery inverter menu level.

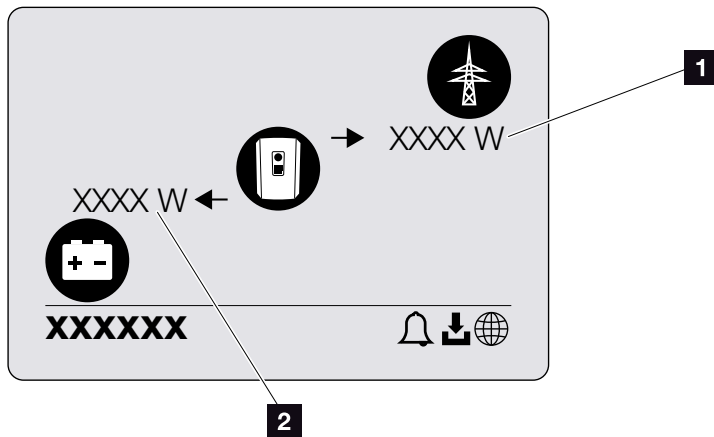

Fig. 40: Power flow diagram

- 1** Power display for public grid
- 2** Power display for battery - charging/discharging

The battery inverter menus

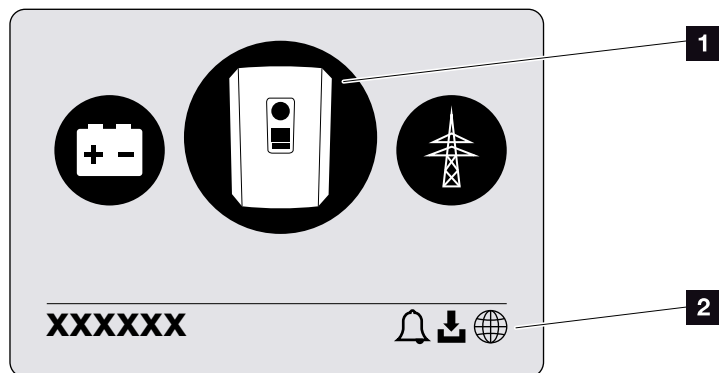





Fig. 41: Main menu structure

- 1** Active menu, selected using “ENTER”
- 2** Status line

The battery inverter provides the following menu items for querying statuses and configuring the battery inverter:

Symbol	Function
	Battery inverter settings
	Status query and information about the grid feed-in (AC side)
	Battery charge and discharge power status query

The menus are listed individually on the following pages.



INFO

The user interface/menu entries in the battery inverter depend on the installed inverter firmware (FW) and the user interface software (UI) in the battery inverter and may deviate from the description provided here.



Settings/information menu

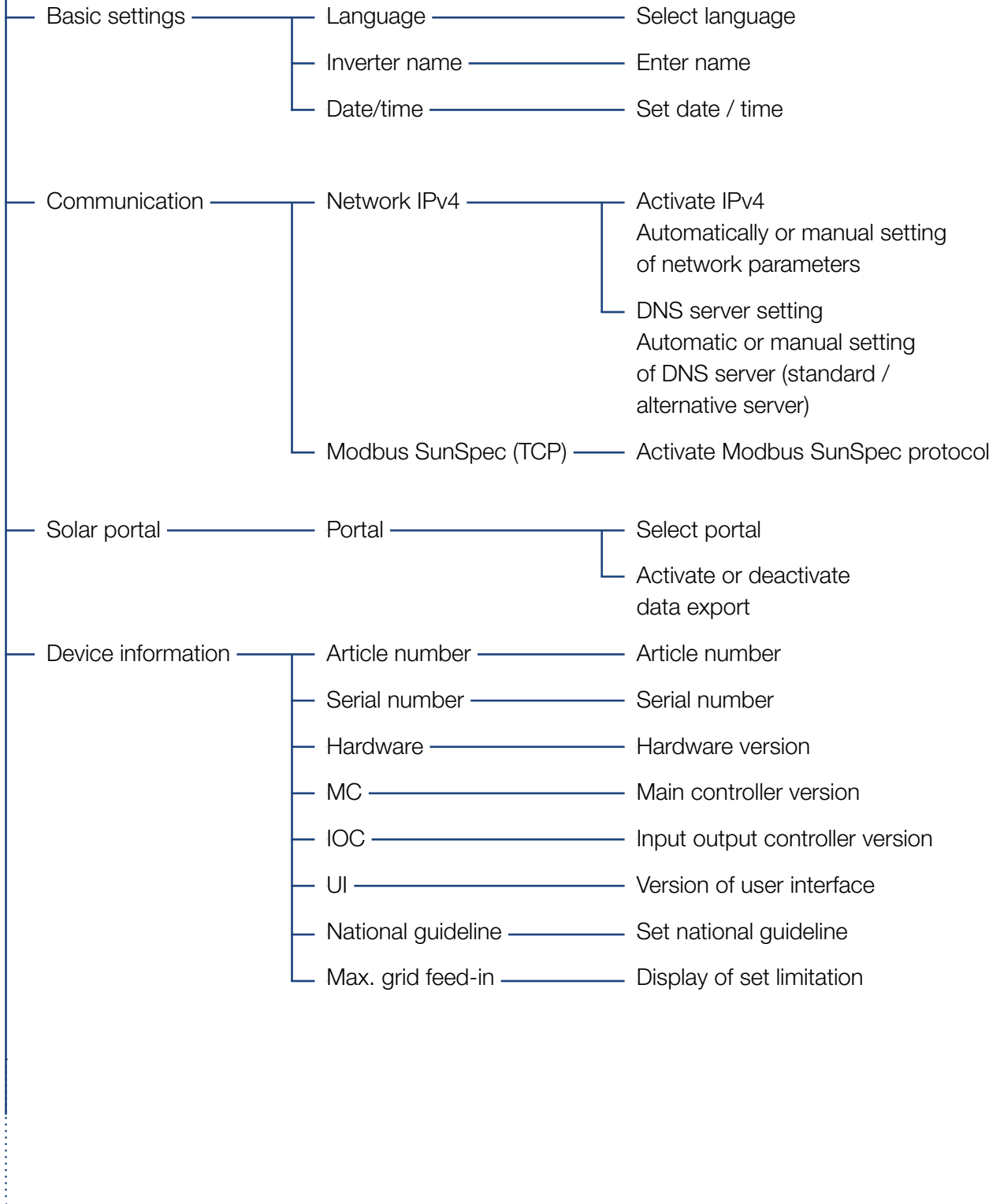

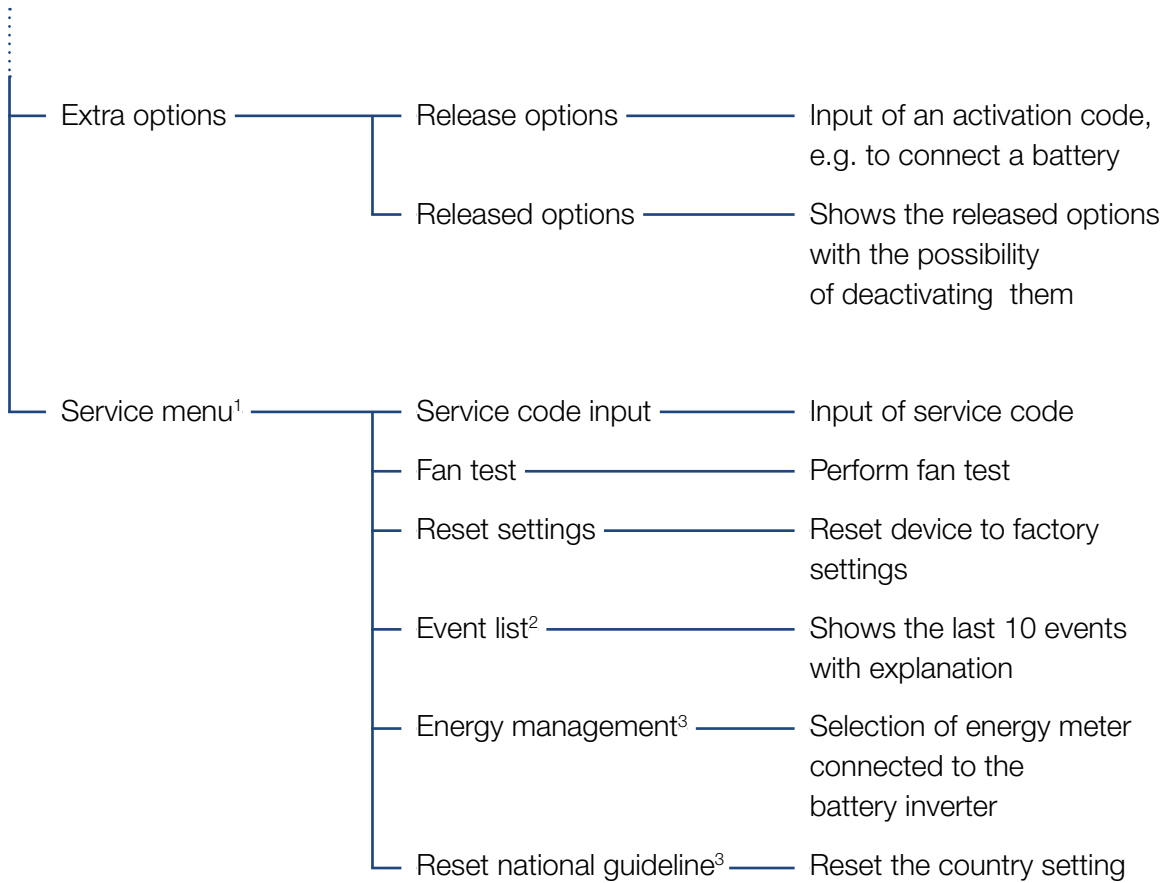

¹ Following entry of the service code, additional menu items for configuring the battery inverter appear. The code can be requested for installers from the Service team.

² A maximum of 10 events are displayed. Information about events can be found in the "Event codes" chapter.

³ Only possible if the service code is entered.



AC menu

- Current AC power ———— Display of voltage (U), current (I) and power (P) per phase emitted or absorbed by PLENTICORE BI.
- Yield overview ———— Display of energy for day, month, year, total in Wh, kWh or MWh emitted by PLENTICORE BI.
- Grid parameter ———— Shows the current grid frequency, set power factor (cos phi), current power.



Battery menu

- Battery status ———— Display of current charging status, voltage, charge or discharge current and number of battery charge cycles.

Settings/information menu

Configuration of the battery inverter and additional components (e.g. energy meter, battery etc.) is performed under Settings/information.

■ Basic setting

Set the general parameters of the battery inverter.

Parameter	Explanation
Language	Selection of menu language
Inverter name	Enter the name of the battery inverter. The characters a-z, A-Z, 0-9 and "-" are permitted for the name change. Spaces or special characters are not possible. The browser connection to the Webserver can be established with the new name following the name change. Access with the serial number remains possible.
Date/time	Enter the time and date. Set the time zone (e.g. UTC (+1:00) for CET) Activate/deactivate or automatic determination of time. The NTP server can be configured via the Webserver.

■ Communication

Set the communication parameters for the battery inverter's Ethernet connection. 

Parameter	Explanation
Network IPv4	<p>Activate the network protocol and configure the network interface (Ethernet) for the battery inverter.</p> <p>The "Automatic" option is activated by default.</p> <p>If configuring manually, the corresponding parameter values should be entered.</p> <p>Set the DNS server:</p> <p>The "Automatic" option is activated by default.</p> <p>If configuring manually, the corresponding parameter values should be entered.</p>
Modbus SunSpec (TCP)	Activate the protocol

■ Solar portal

Input of solar portal configuration. If a solar portal is to be used, the log data and events are then sent to the solar portal.

Parameter	Explanation
Solar portal	Selection of solar portal.
Activate	Activated for starting transmission to a solar portal.



INFO

The "Automatic" option is activated by default. This means that the battery inverter acquires its IP address from a DHCP server or automatically generates an IP address.

If the battery inverter is not allocated an automatic IP address through a DHCP server, the battery inverter can be configured using "Manually".

The data necessary for configuration, such as IP, router addresses etc., can be found on your router/gateway.

■ Device information

Shows information about the versions installed on the battery inverter.

Parameter	Explanation
Article number	Article number of battery inverter
Serial number	Serial number of battery inverter
Hardware	Hardware version
MC	Main controller version
IOC	Input output controller version
UI	User interface version
National guideline	Shows the set battery inverter's country setting
Max. output power	Shows the battery inverter's maximum output power.

■ Extra options

This function can be used to release additional options/ functions for the battery inverter. 

Parameter	Explanation
Release option	Entry of an activation code. This first has to be purchased from the KOSTAL Solar online shop.
Released options	Overview of options currently released in the battery inverter



INFO

The activation code can be purchased from the KOSTAL Solar online shop.

To visit the shop, go to shop.kostal-solar-electric.com

■ **Service menu** 

The installer or an experienced user can use the battery inverter’s service menu to make settings on the battery inverter.

For the complete service menu to be displayed, the installer must request a code from the battery inverter manufacturer’s service team.

The code is entered by going to the “Service code input” menu item.

Once the service code has been entered and confirmed, additional service menu entries appear.

Parameter	Explanation
Service code input	Input of service code and enabling of additional menu items.
Fan test	Start the fan test, e.g. to check it after maintenance or replacement.
Factory settings	Reset the battery inverter to factory settings. This resets the following settings: Language, battery inverter name, date/time, network settings, protocol and solar portal.
Event list	Shows the last 10 events with date. Selecting an event and pressing the “OK” key displays a detailed view of the event.
Energy management (only available once service code has been entered)	Energy meter Selection of the energy meter fitted in the building services
Reset country setting (only available once service code has been entered)	Reset the country setting. After the reset, the commissioning wizard appears on the battery inverter following a restart 



INFO

The service menu entries depend on the installed battery inverter firmware (FW) and the user interface software (UI) and may deviate from the description provided here.

Some menu items can also be run without a service password. These items should only be executed by experienced users because, under certain circumstances, the battery inverter may no longer function correctly.



INFO

Should the battery inverter not restart automatically, switch it off using the DC switch and also switch off the AC line circuit breaker. Wait 10 seconds and then restart in reverse order.

AC menu

Shows the current energy values of the AC side.

■ Current AC power

Shows the current performance data of the grid side (AC) and how the energy is distributed to the phases.

Parameter	Explanation
Phase 1	Shows the voltage, current and power, which is being fed into or taken from the grid.
Phase 2	
Phase 3	

■ Yield overview

Indicates the energy absorbed or emitted by the battery inverter.

Parameter	Explanation
Day	Shows the values for the current day (from 00 to 24 hours).
Month	Shows all values for the current month (from day 1 to day 31).
Year	Shows all values for the current year (from 1 Jan. to 31 Dec.).
Total	Shows the values since commissioning.

■ Grid parameter

Shows the battery inverter's current grid parameters.

Parameter	Explanation
Current grid frequency [Hz]	Shows the grid frequency.
Current cos phi	Indicates the current power factor (cos phi).
Current power	Shows how much battery inverter power is being fed into the house grid.

Battery menu

■ Battery status

If a battery is connected to the battery inverter, the current battery values are displayed here.

Parameter	Explanation
Charging status	Shows the battery's charging status (only when battery is connected).
Voltage	Shows the battery's voltage.
Charge / discharge current	A charging shows that the battery is being charged. A discharge shows that the battery is being discharged.
Number of cycles	Indicates the number of charging cycles of the battery.

5. Connection types

5.1	Battery inverter/computer connection	89
5.2	Settings on the computer	90
5.3	Battery inverter / computer connection	91
5.4	Disconnecting battery inverter/computer connection	93
5.5	Connection via KOSTAL Solar App	94

5.1 Battery inverter/computer connection

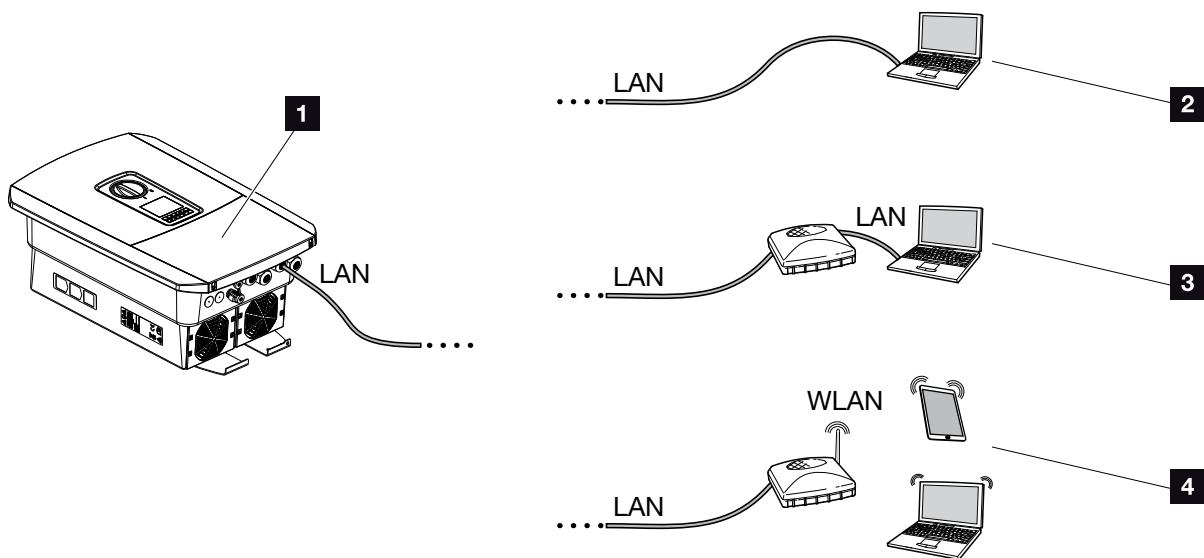

Fig. 42: Connection from computer to battery inverter

- 1** Battery inverter with LAN interface
- 2** Direct connection via LAN
(only with manual IP configuration)
- 3** LAN connection via switch/router
- 4** WLAN connection via WLAN router

For the purposes of configuration or data retrieval, the battery inverter can be connected via a computer or tablet using various types of connection. Several settings should be noted here. These are explained in more detail on the following pages.

For settings relating to the router or Internet, please contact the provider of the router, your provider or a network specialist. **i**



INFO

If the battery inverter is to be accessed via the Internet, this should not be done using the unencrypted HTTP access (port 80).

Instead, preference should be given to encrypted access via HTTPS (port 443) and a VPN connection.

5.2 Settings on the computer

The items listed below relate to the Windows 10 operating system.

- In the Internet protocol (TCP/IP) of the computer, the options "Automatically acquire IP address" and "Automatically acquire DNS server address", must be activated. 

You can go to the settings for the Internet protocol (TCP/IP) via the control panel:

Control Panel >> Network and Sharing Center >> Change Adapter Settings.

Right-click on the LAN connection >> Properties >> Select "Internet protocol (TCP/IPv4)" > Properties.

- In the LAN settings of the computer, the option "Use proxy server for LAN" must be deactivated.

You can reach the "LAN settings" via the control panel:

Control Panel >> Internet options >> Tab: "Connections" >> LAN settings.



INFO

If the computer can already access the network in which the battery inverter is installed, these settings are not required.

5.3 Battery inverter / computer connection

This variant is mainly used when configuring the battery inverter by means of the Webserver on site 

1. De-energise the battery inverter's terminal compartment. 
2. Remove the cover of the battery inverter.
3. Remove the terminal compartment's cover.

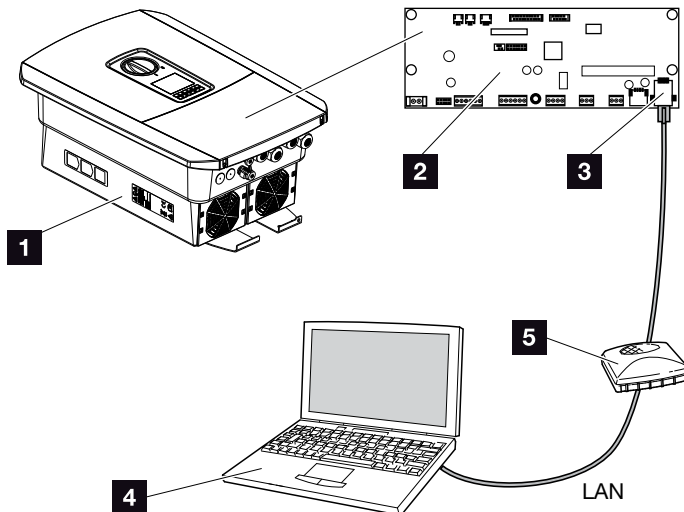

Fig. 43: Connecting battery inverter and computer with an Ethernet cable

- 1 Battery inverter with terminal compartment
 - 2 Smart Communication Board with LAN interface
 - 3 Ethernet cable (LAN)
 - 4 Computer (for configuration or data retrieval)
 - 5 Router
4. Insert Ethernet cable into battery inverter and seal with sealing ring and union nut. Tighten union nut to the prescribed torque. Torque: 8 Nm (M25).



IMPORTANT INFORMATION

Use a patch cable of category 6 (Cat 6e) with a maximum length of 100 m.



DANGER

RISK OF DEATH DUE TO ELECTRICAL SHOCK AND DISCHARGE!

De-energise device and secure against being switched on again.

 Ch. 4.3

5. Connect Ethernet cable to LAN interface of Smart Communication Board.
 6. Connect Ethernet cable to a router or computer. 
 7. Close cover of terminal compartment and battery inverter (2.0 Nm).
 8. Activate fuses and DC switch.
- ✓ The battery inverter is connected to the computer.





INFO

If the battery inverter is connected directly to the PC and if the battery inverter has not yet received its own IP address via a DHCP server, an IP address needs to be configured manually in the battery inverter. This can then be entered into the browser's address line on the PC to access the Webserver.

Connecting the Ethernet cable to a router integrates the battery inverter into your own network and the battery inverter can then be communicated with by all computers incorporated in the same network.

5.4 Disconnecting battery inverter/ computer connection

1. De-energise the battery inverter's terminal compartment.  **Ch. 4.3** 
 2. Remove cover of battery inverter and terminal compartment.
 3. Unplug Ethernet cable from battery inverter and computer. 
 4. Close cover of battery inverter.
 5. Activate fuses and DC switch.
- ✓ Battery inverter operation is restored.



DANGER

RISK OF DEATH DUE TO ELECTRICAL SHOCK AND DISCHARGE!

De-energise device and secure against being switched on again.

 **Ch. 4.3**



TIP

Leave the Ethernet cable connected to the battery inverter. This facilitates further queries or settings on the battery inverter.

If connecting through a router, for example, there is no need to remove the connection.

5.5 Connection via KOSTAL Solar App

The free KOSTAL Solar App provides you with a way of professionally monitoring your photovoltaic system. You can use the KOSTAL Solar App to simply and easily access all functions on your smartphone or tablet at any time.

To set up and use the app, you will need access to the KOSTAL Solar Portal and to have a battery inverter set up there. The same access data used for the KOSTAL Solar Portal is required to log into the app.

You can use the KOSTAL Solar App to easily monitor your photovoltaic system and to display relevant system data both when you are out and about and at home. It allows you to access the consumption and generation data over various time periods, such as day, week, month and year, and to access the historical data of your photovoltaic system. So you are always up-to-date with the KOSTAL Solar App.

Download the free KOSTAL Solar App today and benefit from new and advanced functionalities.

6. Webserver

6.1	The Webserver	96
6.2	Calling up the Webserver	98
6.3	Menu structure of Webserver	100
6.4	Webserver menus	105
6.5	The battery use strategy	130

6.1 The Webserver

Webserver - start screen

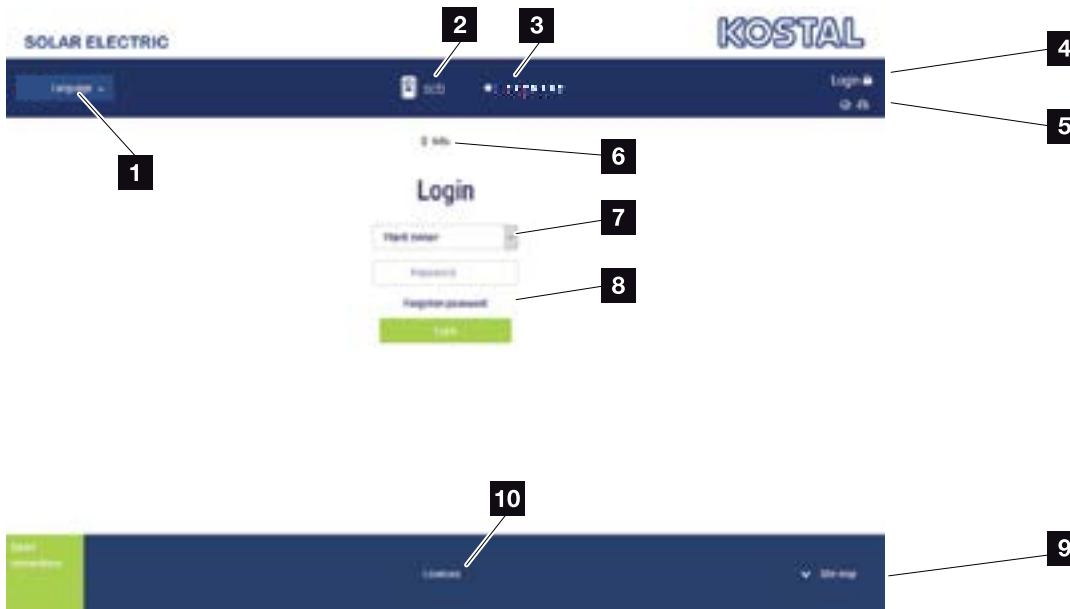

Fig. 44: Webserver - start screen

- 1** Language selection
- 2** Name of battery inverter
- 3** Battery inverter status message
- 4** Webserver login/logout
- 5** Status messages
 - Globe symbol: Status of solar portal connection
 - Download symbol: Software update
- 6** Retrieval of device information
- 7** Login as plant owner or installer
- 8** The user can assign a new password for the Webserver with the "Forgotten password" button or create a new password generally for logging in for the first time.
- 9** Access to sitemap
- 10** Information about licences

The Webserver forms the graphic interface between the battery inverter and user. Information about your system is available here even without logging in. This includes, for example, the device information and the current status of the battery inverter. Go to Login to log in as plant owner or installer. **!**



IMPORTANT INFORMATION

To log in as the plant owner, you need a password, which has to be generated for the first login using "Forgotten password?". For this, you also need the master key from the type plate.

To log in as an installer, you need the master key from the battery inverter's type plate and your service code, which can be requested from our service team. **📄 Ch. 12.2**

Webserver - menus

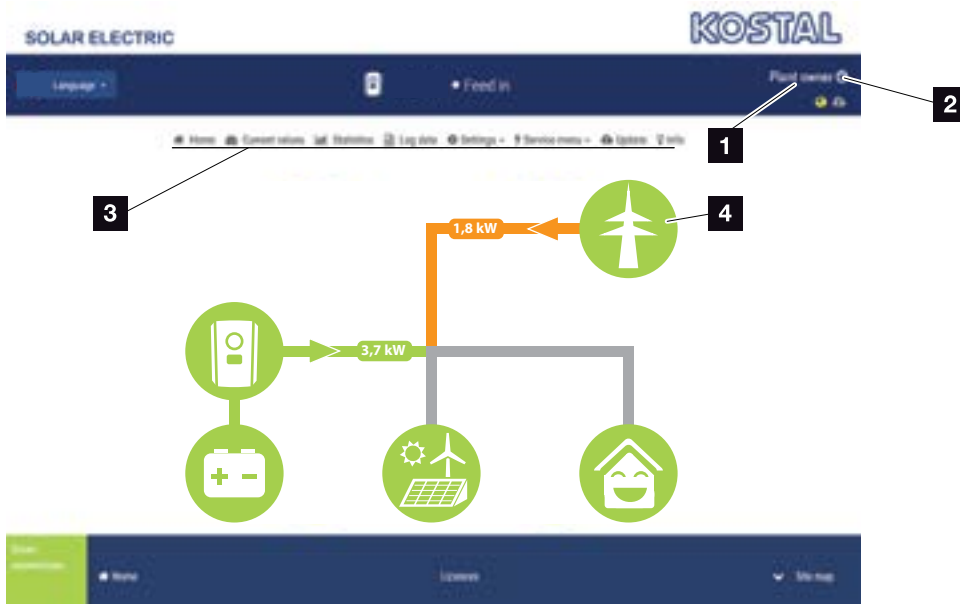

Fig. 45: Webserver - menus

- 1 User logged in
- 2 Logout from the Webserver
- 3 Battery inverter menus
- 4 Energy flow diagram

Once you have logged in as plant owner or installer, you can choose from various menu items. **i**

The Webserver allows the user to view key information, values, events and battery inverter versions.

The statistics provide an overview of yield and remuneration.

The Settings and Service menu allow the battery inverter to be configured quickly and easily. More information about the battery inverter can be found under Log data.

On the next few pages, you will find details of how to log into the Webserver and explanations of individual menu items.





INFO

Depending on user role (installer or plant owner), different menu items can be accessed.

Deviations in the appearance of the Webserver and the menu items described here may be possible due to different software versions (UI version).

6.2 Calling up the Webserver

The Webserver is accessed on the battery inverter from a computer using a web browser (e.g. Internet Explorer, Firefox or Google Chrome). Both devices must be on the same network. 

Information about the connection and settings on the computer  **Ch. 5.**

A user can log into the Webserver as a “Plant owner” or “Installer” using **Login**.

To log into the Webserver as an installer, a personal service code is required along with the master key for the battery inverter (can be found on the battery inverter’s type plate). After logging in, the installer can access advance setting options, which are not available to the normal plant owner. These settings require specialist knowledge. 

Use **Logout**  to log out of the Webserver.



TIP

Any device (e.g. a tablet PC) that has a browser can be used to access the Webserver.





INFO

You can request a service code from our service team.

 **Ch. 12.2**

Logging into the Webserver

Launch an Internet browser.

1. Enter the IP address of the battery inverter in the address line of the browser and confirm with "Enter". 
- The Webserver is called up.
2. As the plant owner, log in with your password. 

If you want to log in as an installer, enter the following data:

Master key: Master key from type plate

Service code: Installer's service code

Confirm the hazard notice and exclusion of liability.

- The Webserver's menu opens.

Making settings in the Webserver

After logging in, the settings required via the Webserver can be made on the battery inverter, or the battery inverter's values can be queried.



TIP

The IP address is shown alternately in the battery inverter display or can be queried in the battery inverter menu.



IMPORTANT INFORMATION

To log in for the first time as the plant owner, you first have to have a password. This can be obtained using "Forgotten password". In the following menu, enter the master key and a new password. You will find the master key on the battery inverter's type plate.

The password must comprise at least 8 characters and include the following combination of characters: a-z, A-Z, 0-9

Should you forget your password, it can be re-assigned in the same way.

6.3 Menu structure of Webserver

Deviations due to software versions (UI status) possible.

Home menu

 Home ————— Display of power flow diagram

Current values menu

 Current values —————

- Inverter ————— Display of battery inverter status and active events
- Grid ————— Display of power drawn from the grid (house grid)
- Battery ————— Shows the current values of battery, such as status, current, power, charge status and charge cycles

Statistics menu

 Statistics —————

- Daily yield ————— Shows yield for current day
- Monthly yield ————— Shows yield for current month
- Annual yield ————— Display of yield for current year
- Total yield ————— Display of total yield

Log data menu

 Log data ————— Log data ————— Download log data from the battery inverter

Settings menu

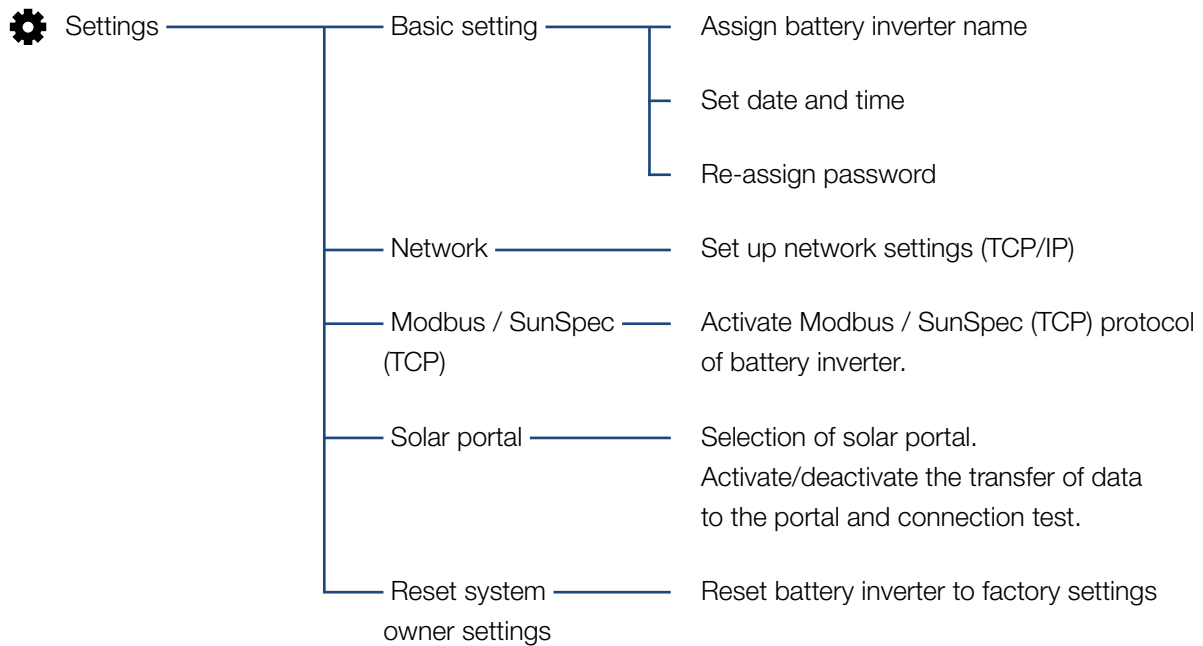

Service menu – general

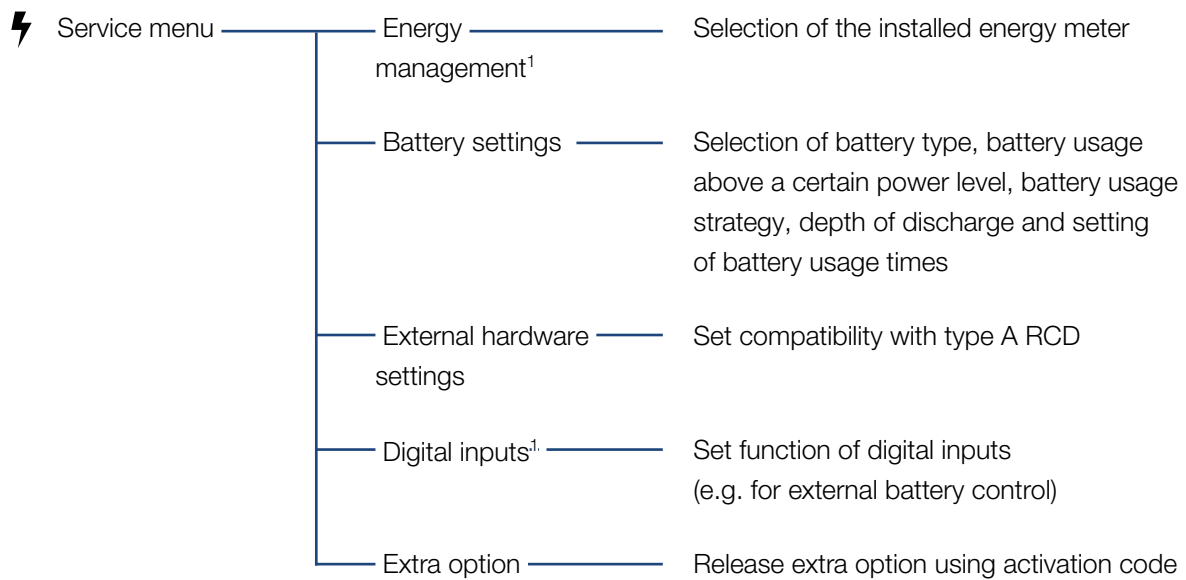

¹ Can only be changed with a service code

Service menu – grid parameterization

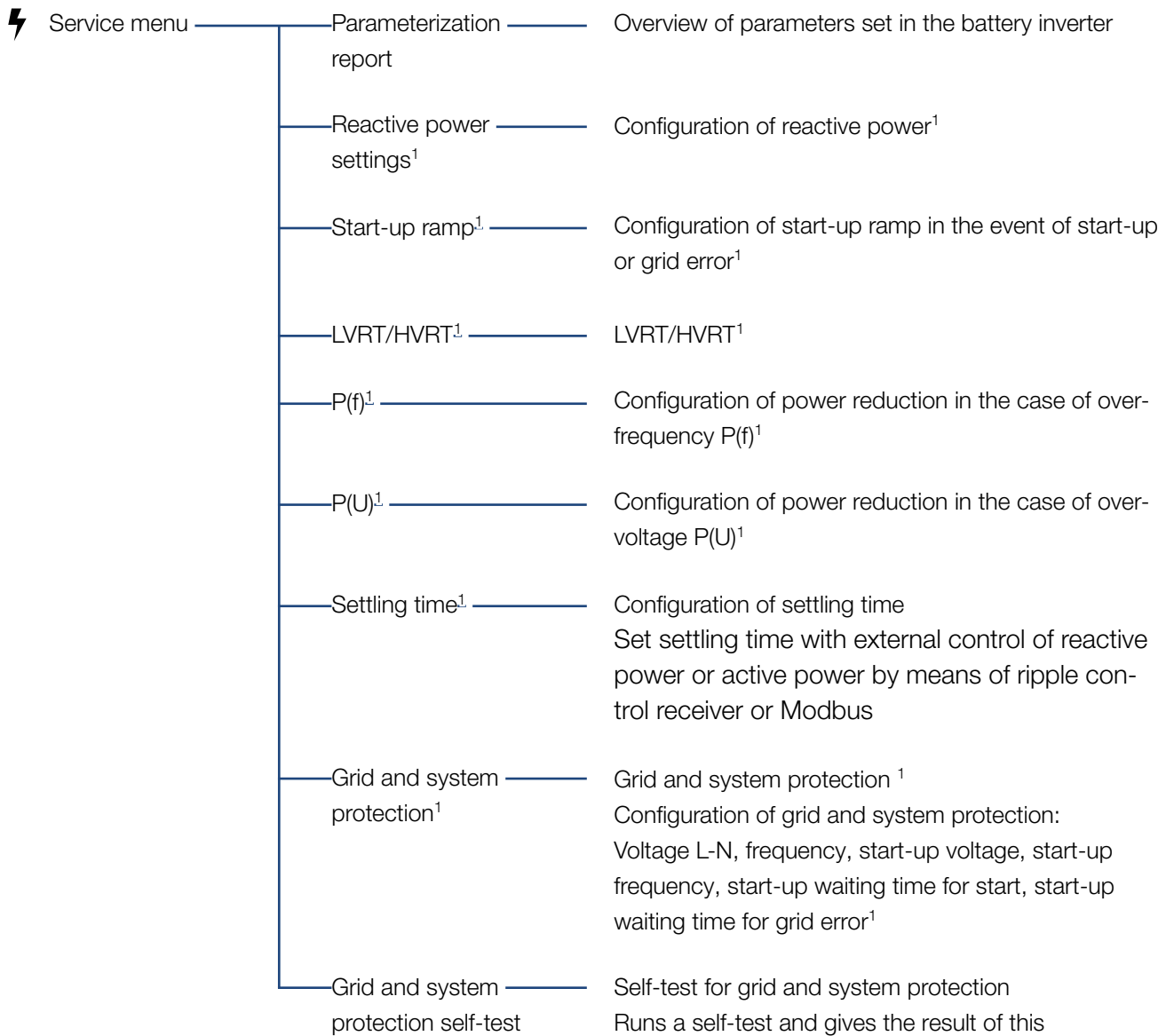

¹ Can only be changed with a service code.

Update menu

 Update ————— Update ————— Perform a software update of the battery inverter.

Info menu

 Info ————— Device information ————— Displays device and network information as well as events that are pending in the battery inverter.

6.4 Webserver menus

The following menus are available to the user in the Webserver. A more detailed description of the individual items is provided on the following pages:

- **Home**
Shows power flow diagram
- **Current values**
Using various statistics, the user can display the current values for daily, monthly, annual and total yield. Detailed information can be displayed by expanding the statistics.
- **Statistics**
Shows information about the battery inverter's yield data for daily, monthly, annual or total time periods.
- **Log data**
The battery inverter's log data can be downloaded in total or for a limited time period here.
- **Settings**
Use these menu items to configure the basic settings of the battery inverter (e.g. battery inverter name, network settings).
- **Service menu**
These menu items allow the installer to configure the hardware of the battery inverter (e.g. battery settings and grid parameters).

- **Update**

This menu item can be used to update the battery inverter by means of a software update.

- **Info**

On the Info page, the user can view events pending in the inverter or the battery inverter's installed versions (e.g. UI, MC, IOC, HW). This information can also be viewed without logging into the Webserver.

Webserver menu - home

■ Home

Shows the power flow diagram. The directions of flow for the energy to and from the battery inverter are shown. The values indicate the power currently present.

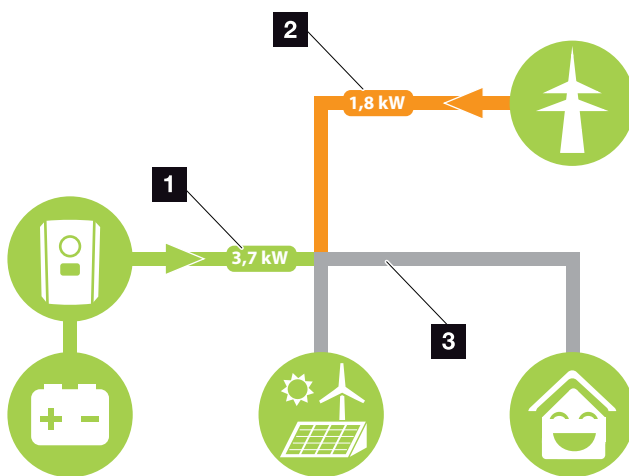

Fig. 46: Energy flow diagram

- 1** Green: Energy is emitted from the battery into the house grid.
Orange: Energy is stored in the battery from the house grid or, if necessary, from the public grid.
- 2** Green: Energy is emitted from the house grid into the public grid.
Orange: Energy is taken from the public grid and consumed in the house grid or, if necessary, stored in the battery.
- 3** Grey: Energy flow not measurable

Webserver menu - current values

Menu items to display the current energy values of the AC and DC side.

■ Inverter

Shows the current status of the battery inverter, current performance data of the grid side (AC) and how the energy is distributed to the phases.

Parameter	Explanation
Status	Operating status of battery inverter. For more information, see Ch. 4.5 .
Digital inputs	Signal status of digital interface terminal (input 1-4). The display shows whether the feed-in is currently limited, e.g. by an external battery management system. Settings e.g. for user-defined control can be configured by going to Service menu > Digital inputs. Ch. 8.1 .
Output power	Shows how much battery inverter power is being fed into the house grid.
Grid frequency	Shows the current grid frequency
Cos phi	Indicates the current power factor (cos phi)
Phase x	Shows the power values per phase (x = 1, 2 or 3)

■ Grid

Shows the current performance data of the grid side (AC).

Parameter	Explanation
Grid	<p>Feed-in: Energy is fed into the house grid.</p> <p>Purchase: Energy is stored in the battery from AC energy sources located in the house grid.</p>

■ Battery

If a battery is connected to the battery inverter, the current battery values are displayed here. 

Parameter	Explanation
Status	Charge: The battery is charged Discharge: Energy is drawn from the battery.
Voltage	Shows the battery's charge/discharge voltage.
Current	Shows the battery's charge/discharge current.
Power	Shows the battery's charge/discharge power.
Charging status	Shows the battery's charging status (SOC) in %.
Charging cycles	Shows the battery's charging cycles.



INFO

If all values are at zero, the battery is in sleep mode. You can check the status of the battery by going to Current values > Inverter.

Webserver menu - statistics

Shows the yield for the day, month, year and total.

■ Yield statistics

Shows the yield/consumption values.

Parameter	Function
Day	Shows the yield/consumption values for the current day.
Month	Shows the yield/consumption values for the current month.
Year	Shows the yield/consumption values for the current year.
Total	Shows all yield/consumption values that have accumulated in the battery inverter.

Webserver menu - log data

Retrieve log data from the battery inverter. 

Menu item	Function
Log data download	Restricted time period: Download a selected time period of log data from the battery inverter (max. 100 days).

The log data of the battery inverter can be downloaded as a file (logData.csv). The data in the file is in CSV format and can be viewed with any spreadsheet program (e.g. Excel).

For more information, see  **Ch. 7.2.**

The data is saved on your hard drive. After saving, this data can be displayed and further processed. 



INFO

The data is saved in the battery inverter for around 365 days. When the internal memory is full, the oldest data will be overwritten.



INFO

If the battery inverter is not connected to a solar portal, regular backup copies of the log data should be created.

Webserver menu - settings

The battery inverter and the external components (e.g. ripple control receiver etc.) can be configured under Settings.

■ Basic settings

Set the general parameters of the battery inverter.

Inverter name

Set the general parameters of the battery inverter.

Menu item	Function
Inverter name	Input of battery inverter name (max. 63 characters). The following characters are permitted: a–z, A–Z, 0–9 and "-". Spaces or special characters are not possible. The browser connection to the Webserver can be established with the new name following the name change or can continue using the IP address.

■ **Time setting**

Set time/date or select a time server.

Menu item	Function
Date and time	Input of time / date. The time can be taken from the PC.
Time zone	Set the time zone (e.g. UTC (+1:00) for CET)
Use time server (NTP)	Activate/deactivate a timer server (NTP server). After activation, the time from the time server is used. By using the NTP server, the switch between summer and winter time is also performed automatically.
NTP server	Input of IP address or name of NTP server (Network Time Protocol). Other, alternative NTP servers can be added via Plus. There are numerous free NTP servers in the Internet, which can be used here.



Change password

Change Webserver password.

Menu item	Function
Change password	Change Webserver password. The password must comprise at least 8 characters and include the following combination of characters: lower-case letters (a-z), upper-case letters (A-Z) and numbers (0-9).

■ **Network**

Set the communication parameters of the battery inverter.

Menu item	Function
Automatically acquire IPv4 address	If the box is ticked, the IP address is generated automatically by a DHCP server. Most routers provide a DHCP server as standard. 
IPv4 address (only with manual configuration)	Enter the IP address of the battery inverter 
Subnet mask (only with manual configuration)	Enter the subnet mask e. g. 255.255.255.0
Router/gateway (only with manual configuration)	Enter the IP address of the router
DNS server 1 (only with manual configuration)	Enter the IP address of the DNS server (Domain Name System)
DNS server 2 (only with manual configuration)	Enter the IP address of the backup DNS server (Domain Name System)

■ **Modbus / SunSpec (TCP)**

Activate the protocol, which can be used in the battery inverter to exchange data with external data loggers, linked to the battery inverter via the LAN interface.

Menu item	Function
Activate Modbus	Output of port (1502) and ID (71) parameters for Modbus / SunSpec. Activate the protocol on the LAN TCP/IP interface. Used for an external data logger, for example. No further settings are needed.



INFO

The "Obtain IP address automatically" option is activated by default. This means that the battery inverter obtains its IP address from a DHCP server.



INFO

If the battery inverter is not allocated an IP address automatically through a DHCP server, the battery inverter can be configured manually.

The data necessary for configuration, such as IP, subnet mask, router and DNS addresses, can be found on your router/gateway.

■ **Solar portal**

Input of solar portal configuration. If you want to use a solar portal, the log data and events can be sent to the solar portal. 

Menu item	Function
Use portal	Activates the transfer to the solar portal.
Portal	Selection of solar portal.
Last transfer	Indicates when the battery inverter last transferred data to the solar portal (provided the function is active).
Last successful transfer	Indicates when the battery inverter last successfully transferred data to the solar portal (provided the function is active).



INFO

The solar portal can only be used for inverters, which are linked to the Internet.

■ **Reset system owner settings**

Reset system owner settings to factory settings.

Menu item	Function
Reset system owner settings	The values for the basic settings, network, Modbus/SunSpec and solar portal are reset to the factory settings.

Webserver menu - Service menu - General

The installer can find more configuration options for configuring the battery inverter in the Service menu. In order to configure these settings, precise knowledge of the requirements of the public grid specified by the energy supply company (e.g. reduce active power, set parameters, which are specified by the energy supply company) is required. 

■ Energy management (can only be configured with service code)

Selection of the connected energy meter on the battery inverter and the feed-in limitation to the public grid. 

Menu item	Function
Energy meter	Selection of connected energy meter.
Sensor position	The energy meter must be installed at the grid connection point (position 2). Position 1 (home consumption path) is not possible.



INFO



The settings in this menu requires special knowledge of the grid configuration.



INFO

A list of approved energy meters and their purpose are available in the download area for the product on our homepage at www.kostal-solar-electric.com

■ **Battery settings**

If a battery is connected to the battery inverter, its behaviour and usage of the battery can be configured here.  

Parameter	Function
Battery type	Selection of battery connected to battery inverter. 
Battery usage from a grid demand of xxx W	Input of a minimum grid demand value from which the battery is used. (Standard 50 W.) Example: If a value of 200 W is set, the battery can only be released to cover the home consumption when the measured grid demand from the public grid exceeds 200 W. The battery is blocked again for home consumption when the grid demand falls 50 W below the set value (in this example 150 W).
Battery charge from excess energy as from [W]	Input of a minimum value. From this value on, the battery is charged as from excess AC energy from the house grid (default 0 W). Example: If a value of 200 W is set, the battery will be charged as soon as the energy meter measures an excess of AC energy in the house grid of more than 200 W. The battery is blocked again for storage when the value falls below 50 W of the set value (here in the example 150 W).



INFO

Some of the functions described here will only be made available later via a software update.





IMPORTANT INFORMATION

If a battery is set up at a later date via the Webserver or battery inverter, use the DC switch to switch the battery inverter off and on again after configuration so that the settings are adopted.



INFO

You will find a list of approved battery storage systems in the download area for the product on our homepage at www.kostal-solar-electric.com

Parameter	Function
Battery use strategy	<p>Select battery use strategy.</p> <p>The following modes are available: automatically (standard), automatically economical.</p> <p>Automatically:  The battery inverter controls the battery charge automatically. In this mode, the battery is not switched off.</p> <p>Automatically economical:  The battery inverter controls the battery charge automatically, but switches the battery off if there is not enough energy available to charge the battery for long periods.</p>





INFO

This setting is recommended for regions with little snowfall.



INFO

This setting is recommended for regions with a lot of snowfall.

Parameter	Function
External battery management	<p>The battery can be controlled by an external battery management system (e.g. energy supplier). In this case, the charge/discharge capacity of the battery is controlled by the external supplier. The plant owner then receives remuneration for the energy provided, e.g. from the external supplier  Ch. 8.1.</p> <p>Internal (standard): The external control is deactivated.</p> <p>Via Modbus (TCP): The external battery management is provided via the Modbus RTU protocol. The control signals are received via the LAN interface. If there are no control signals, the system switches to internal control. Interrogation of the device status via Modbus (TCP) / SunSpec is still possible in parallel.</p> <p>Via digital I/O: External battery management is carried out via the digital inputs on the Smart Communication Board (terminal X401) of the inverter. A presetting can be selected or the digital inputs can be configured according to the provider's specifications. If there are no control signals, the system switches to internal control. Interrogation of the device status via Modbus (TCP) / SunSpec is still possible in parallel  Ch. 8.1.</p>
Min. charge status (SOC) [%]	<p>Set the minimum depth of discharge of the battery. </p>



INFO

Setting the depth of discharge allows you to keep a reserve in the battery.

For example, a value of 100 % prevents the battery from having to be continually recharged from the public grid in the winter because the battery cannot be charged using AC energy sources, for example.

A value of 100 % is the equivalent of a fully charged battery.

Parameter	Function
Timed battery use	<p>The charging and discharging operation can be configured very flexibly at different times (tariff periods).</p> <p>There are times when the costs of electricity procurement are relatively high (different tariff models). It may therefore be useful to allow the battery to be discharged during these periods and to allow charging (also from the grid if permitted by the grid operator) outside these periods.</p> <p>The times set here can be overridden by the specifications of an activated external battery management system.</p> <p>Battery charge blocked: Discharging permitted in the event of demand from house.</p> <p>Battery discharge blocked: Charging permitted in the event of excess power.</p>
Reset battery mode (only possible with service code)	<p>This function resets the battery's winter mode (sleep mode 1 or 2) until the next inspection. </p>



INFO

This function is needed if e.g. a battery module is being exchanged in the winter in order to charge and check the function of this module.

■ **External hardware settings**

(can only be configured with service code)



Settings for hardware settings.

Menu item	Function
Residual current protection equipment	<p>Compatibility of type A RCD:</p> <p>If this function has been activated, type A RCDs can be used as residual current protection equipment. The battery inverter shuts down here when the residual current becomes incompatible for a type A RCD.</p> <p>If the function is deactivated, a type B RCD must be used as residual current protection equipment if a RCD is stipulated.</p>

■ **Digital inputs**

(can only be configured with service code)

Selection of the use of digital inputs on the Smart Communication Board (terminal X401).

Menu item	Function
none	There is nothing connected to the digital inputs.
External trip input	Setting for external switch-off via trip signal. A voltage VDD is applied here to input 1 for trip signal. 
Parameter set changeover	<p>Setting for local switching via parameter set. A voltage VDD is applied at input 3. The parameter set is then activated as soon as there is also voltage at input 2.</p> <p>The switch-off limits that can be activated for changeover via the parameter set must be set for this purpose under Grid and system protection. </p>



INFO

Please note for Italy that the connection with an external voltage source and a changeover switch to GND is mandatory.



INFO

Please note for Italy that the connection with an external voltage source and a changeover switch to GND is mandatory.

Menu item	Function
External trip and parameter set changeover	<p>Setting for external changeover via parameter set. A voltage VDD is applied at input 2. The set parameter is activated as soon as there is also voltage at input 3.</p> <p>The switch-off limits that can be activated for changeover via parameter set must be set for this purpose under Grid and system protection.</p> 
External battery control	<p>If you have activated external control via the digital I/O ports in the "Battery settings" menu, you can define the functions of the inputs here. Assign the desired charge or discharge power to the inputs.</p>



INFO

Please note for Italy that the connection with an external voltage source and a changeover switch to GND is mandatory.

■ Extra options

This function can be used to release additional options for the battery inverter.

Parameter	Explanation
Release new option	Entry of an activation code. This first has to be purchased from the KOSTAL Solar online shop. 
Released options	Overview of the currently enabled options in the battery inverter (e.g. battery function)



INFO

The activation code can be purchased from the KOSTAL Solar online shop.

To visit the shop, go to shop.kostal-solar-electric.com

Webserver menu - service menu - grid parameterization

The following menu items can be used to set the parameters in the battery inverter, which are specified by the grid operator.

Parameters may only be changed on the battery inverter by qualified electrical technicians who are familiar with the system and at the request of the grid operator.

Inappropriate settings can be hazardous and lead to injury or even death of the user or third parties. Material damage to the device and other equipment can also occur.

- **Show parameterisation report**
Issues an overview of the parameters set in the battery inverter.
- **Reactive power settings (can only be configured with service code)**

The following selection options are available:

Parameter	Function
No reactive power mode active	No reactive power is set.
Reactive power Q	The grid operator (energy supply company) specifies a fixed reactive power in Var.
Displacement factor $\cos \phi$	The grid operator specifies a fixed displacement factor $\cos \phi$.
Reactive power / voltage characteristic curve Q(U)	The grid operator specifies a characteristic curve Q(U).
Displacement factor / power curve $\cos \phi$	The grid operator specifies a characteristic curve for $\cos \phi$ (P).



IMPORTANT INFORMATION

The settings may only be adjusted by trained and qualified electrical technicians.

The electrician is responsible for ensuring that the applicable standards and regulations are observed and implemented. Work that could affect the electrical power system of the respective energy supply company at the site of the solar energy feed-in may only be carried out by qualified electricians expressly authorised (licensed) by the energy supply company.

This includes changes to the factory preset parameters of the battery inverter.

■ **Configuration of the start-up ramp
(can only be configured with service code)**

Parameter	Function
Ramp time [s]	States the time in seconds after a restart or grid error for which the battery inverter waits before starting up. The ramp time is also used for P(f) and P(U).

■ **Configuration of LVRT/HVRT
(can only be configured with service code)**

Parameter	Function
LVRT	Configuration of Low-Voltage-Ride-Through LVRT is the electrical ability to provide dynamic grid support through electrical generation units.
HVRT	Configuration of High-Voltage-Ride-Through HVRT is the electrical ability to provide dynamic grid support through electrical generation units.

■ **Configuration of power reduction at overfrequency P(f)
(can only be configured with service code)**

Parameter	Function
Reduction curve	The characteristic curve is defined by a change in frequency which is expressed as a percentage of the rated frequency and causes a 100 % change in rated output.
Conditions for returning to normal mode	Input of frequency range and waiting time in seconds

■ **Configuration of power reduction at overvoltage P(U)**
(can only be configured with service code)

Parameter	Function
Reduction curve	The characteristic curve is defined by a voltage start and end point. The power is reduced by 0 % at the start point and by 100 % at the end point.
Settling time	Selection of the settling time
Conditions for returning to normal mode	The reduction in power ends once the voltage has fallen below the specified value and the stated waiting time has passed.

■ **Settling time**
(can only be configured with service code)

Set the settling time with external control of reactive power or active power by means of ripple control receiver or Modbus.

Parameter	Function
Settling time [s]	With external control of reactive power (Q , $\cos \phi$), the settling time can be set in seconds. Select the specifications of the grid operator (energy supply company) here.
Mode	With external control of active power, the following parameters can be set. Standard: no further details needed (default) PT1: Selection of the settling time in seconds. Power gradient: Input of maximum power limit gradient. Enter the specifications of the grid operator (energy supply company) here.

■ **Grid and system protection (can only be configured with service code)**

The settings for the grid and system protection may only be changed in exceptional cases for good reason and in consultation with the grid operator (energy supply company).

Parameter	Function
Shutdown limits for voltage	The settings for the grid and system protection may only be changed in exceptional cases for good reason and in consultation with the grid operator (energy supply company). Enter the specified values in the corresponding fields.
Shutdown limits for frequency	
Use switchable shutdown limits	
Start-up conditions	

■ **Self-test for grid and system protection**

Runs a self-test with the set values and produces the result of this.

Webserver menu - update

This function can be used to load software updates into the battery inverter. To do this, drag the update file (*.swu) into the box or use the button to select a file on your computer and launch the installation.

The latest software for your product is available from the [Download area](#) on our homepage by going to Product category > Model > Country > Update.

Webserver menu - info

Displays all events and versions of the battery inverter.

■ Device information - devices

Provides information about the versions installed in the battery inverter. The information about the device can also be viewed without logging into the Webserver.

Function	Meaning
Name of device	Name of battery inverter. Can be changed by going to Settings > Basic settings.
Type designation	Type designation of battery inverter
Serial number	Serial number of battery inverter
Article number	Article number of battery inverter
UI version	User interface version
MC version	Main controller software version
IOC version	I/O controller software version
HW version	Hardware version
Guideline	Shows the set battery inverter's country setting
Battery input	Status DC input battery (default: enabled)

■ Device information - network

Provides information about the specified network settings.

Function	Meaning
Network information	Static The network settings were specified manually. DHCP The network settings are obtained automatically.
IPv4 address	Shows the specified IP address of the battery inverter
Subnet mask	Shows the specified subnet address
Gateway	Shows the router/gateway address
DNS server	Shows the address of the 1st and 2nd DNS server (Dynamic Name Server)
MAC address	Displays the MAC address of the inverter
Last connection to the solar portal	Last transfer in minutes or time

■ Device information - events

Up to 10 events can be displayed. Additional information about the event can be displayed via Info (i) next to the event.

6.5 The battery use strategy

Multiple variants of the charge strategy can be activated for a battery connected to the battery inverter.

Principle of operation of automatic mode

In automatic mode, the battery inverter controls how the battery is charged and discharged over the entire year itself. The battery is not switched off and is therefore available all year round.

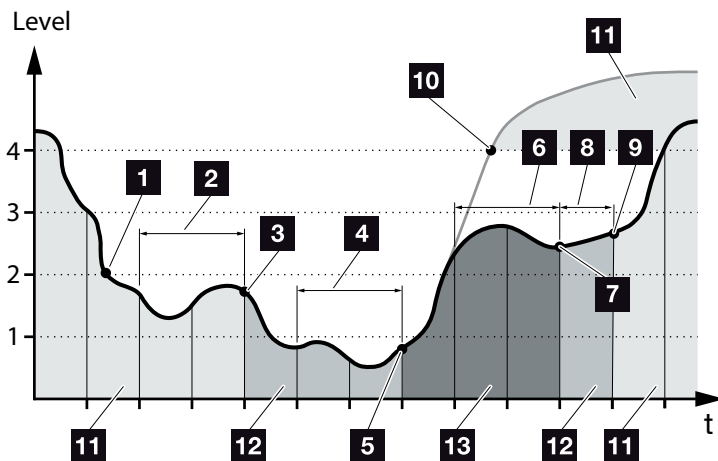

Fig. 47: Automatic mode

- 1** If the energy produced daily from local generators is above level 2, the battery inverter is in normal operation. The battery is charged by the battery inverter using the energy available from local generators and energy can be emitted to consumers in the house grid.
- 2** The energy produced daily by local generators falls below level 2 for two consecutive days.
- 3** The discharge of the battery is reduced to 40 % SOC by the battery inverter. “Battery sleep mode 1” is displayed on the battery inverter. When the minimum SOC of the battery is reached, it receives trickle charges via the battery inverter.
- 4** The energy produced daily by local generators falls below level 1 for two more days in a row.

- 5 Initially, the battery is charged using energy from local generators or, if this is not available, via the public grid. The battery inverter then stops charging and discharging the battery as long as the SOC is still below 40 %. The “Battery sleep mode 2” message is given on the battery inverter.
- 6 The energy produced daily by local generators is above level 2 for two consecutive days or rises immediately above level 3.
- 7 The battery is reactivated from sleep mode, but energy cannot yet be drawn from the battery while the SOC is still below 40 %.
- 8 The energy from local generators remains above level 2 for another day.
- 9 The battery is switched into normal mode.
- 10 If the energy from local generators rises above level 4, the battery is switched immediately to normal state.
- 11 Battery normal mode
- 12 Battery sleep mode 1
- 13 Battery sleep mode 2

“Automatically economical” functional mode

In contrast to "Automatic" mode, the battery is switched off here as soon as the energy from local generators falls below the level 1 limit for two consecutive days.

Fig. 47, It. 5

The “Battery sleep mode 2” message is given on the battery inverter.

Before the battery is switched off, it is charged.

7. System monitoring

7.1	The log data	133
7.2	Retrieving, saving and graphically depicting log data	137
7.3	The KOSTAL Solar Portal	139
7.4	Remote service	140

7.1 The log data

The battery inverter is equipped with a data logger, which regularly records the following data from the system:

- Battery inverter data
- External energy meter data
- Grid data
- ENS data
- Battery data

You can find out how to retrieve, save and graphically depict log data in the following chapter [Ch. 7.2](#)

The log data can be used for the following purposes:

- Check operating characteristics of the system
- Determine and analyse errors
- Download and graphically depict yield data

Date	DC1	DC2	DC3	DC4	DC5	DC6	DC7	DC8	DC9	DC10	DC11	DC12	DC13	DC14	DC15
01.01.2020	0	0	0	0	0	0	0	0	0	0	0	0	0	0	0
02.01.2020	237	0	0	0	0	0	0	0	0	0	0	0	0	0	0
03.01.2020	442	0	0	0	0	0	0	0	0	0	0	0	0	0	0
04.01.2020	442	0	0	0	0	0	0	0	0	0	0	0	0	0	0
05.01.2020	442	0	0	0	0	0	0	0	0	0	0	0	0	0	0
06.01.2020	442	0	0	0	0	0	0	0	0	0	0	0	0	0	0
07.01.2020	442	0	0	0	0	0	0	0	0	0	0	0	0	0	0
08.01.2020	442	0	0	0	0	0	0	0	0	0	0	0	0	0	0
09.01.2020	442	0	0	0	0	0	0	0	0	0	0	0	0	0	0
10.01.2020	442	0	0	0	0	0	0	0	0	0	0	0	0	0	0
11.01.2020	442	0	0	0	0	0	0	0	0	0	0	0	0	0	0
12.01.2020	442	0	0	0	0	0	0	0	0	0	0	0	0	0	0
13.01.2020	442	0	0	0	0	0	0	0	0	0	0	0	0	0	0
14.01.2020	442	0	0	0	0	0	0	0	0	0	0	0	0	0	0
15.01.2020	442	0	0	0	0	0	0	0	0	0	0	0	0	0	0
16.01.2020	442	0	0	0	0	0	0	0	0	0	0	0	0	0	0
17.01.2020	442	0	0	0	0	0	0	0	0	0	0	0	0	0	0
18.01.2020	442	0	0	0	0	0	0	0	0	0	0	0	0	0	0
19.01.2020	442	0	0	0	0	0	0	0	0	0	0	0	0	0	0
20.01.2020	442	0	0	0	0	0	0	0	0	0	0	0	0	0	0
21.01.2020	442	0	0	0	0	0	0	0	0	0	0	0	0	0	0
22.01.2020	442	0	0	0	0	0	0	0	0	0	0	0	0	0	0
23.01.2020	442	0	0	0	0	0	0	0	0	0	0	0	0	0	0
24.01.2020	442	0	0	0	0	0	0	0	0	0	0	0	0	0	0
25.01.2020	442	0	0	0	0	0	0	0	0	0	0	0	0	0	0

Fig. 48: Example screen "The log file"

- 1 File header
- 2 Physical variables
- 3 Entries in the log file

Log file: File header

The log file contains a file header with information about the battery inverter:

Entry	Explanation
Inverter number	Number of battery inverter (always 1)
Name	Can be assigned by the user via the browser
Current time	The system time valid at the point in time of file creation in seconds. This makes allocation possible (e.g. 1372170173 Unix time stamp = 25.06.2013 16:22:53) 

Tab. 5: Log file file header



INFO

Unix time stamp converter can be found online.

Log file: Physical variables

The file header is followed by the units of the physical variables. The following table explains the abbreviations for the physical variables:

Entry	Explanation
U	Voltage in volts [V]
I	Current strength in milliamps [mA]
P	Power in watts [W]
E	Energy in kilowatt hours [kWh]
F	Frequency in Hertz [Hz]
R	Resistance in kilohms [kOhm]
T	Counting unit in points [digits]
Aln T	Counting unit in points [digits]
Time	Time in seconds [sec] since the battery inverter was commissioned
TE	Temperature in Celsius [°C]
H	No function [%]

Tab. 6: Physical variables in the log file

Log file: Entries

The units of the physical variables are followed by various entries in the log file.

The following table explains the various entries of the log file and may deviate depending upon the model:

Entry	Explanation
Time	Time in seconds since the battery inverter was commissioned
DCx U	DC voltage: Input voltage of the respective string (x = 1, 2 and 3) in V
DCx I	DC current: Input current of the respective string (x = 1, 2 and 3) in mA
DCx P	DC power: Input power of the respective string (x = 1, 2 and 3) in W
DCx T	DC temperature: Details for service. Temperature of the respective phase (x = 1, 2 and 3) in digital values
DCx S	DC status: Details for service of the respective string (x = 1, 2 and 3)
ACx U	AC voltage: Output voltage of the respective phase (x = 1, 2 and 3) in V
ACx I	AC current: Output current of the respective phase (x = 1, 2 and 3) in mA
ACx P	AC power: Output power of the respective phase (x = 1, 2 and 3) in W
ACx T	AC temperature: Details for service. Temperature of the respective phase (1, 2 and 3) in digital values
AC F	AC frequency: Grid frequency in Hz
FC I	Residual current: Measured residual current in mA
Aln1-4	Is not used
AC S	AC status: Details for service of the operational status of the battery inverter
ERR	General malfunctions
ENS S	Status of the ENS (device for grid monitoring with assigned switching elements): Status of grid monitoring
ENS Err	Malfunctions of the ENS (device for grid monitoring with assigned switching elements)
SHx P	External current sensor power: Power of the respective phase (x = 1, 2 and 3) in W
SCx P	Self-consumption at the respective phase (x = 1, 2 and 3) in W
HC1 P	not used
HC2 P	Home consumption in W from the PV modules
HC3 P	Home consumption in W from the grid
SOC H	Battery charge status (SOC = State of charge)
BAT Te	Battery temperature
BAT Cy	Number of battery charge cycles
KB S	Internal communication status when switching to AC grid
Total E	Total energy in kWh, which has been generated by the battery inverter and is being transferred to the AC grid in the house.
OWN E	Self-consumption: Energy in kWh currently being consumed in the house, which is covered by the battery inverter.

Entry	Explanation
HOME E	Home consumption: Energy in kWh currently being consumed in the house, which is covered by the battery inverter and from the AC grid.
Iso R	Insulation resistance in kOhm when switching to AC grid
Event	POR event, "power on reset": Renewed start-up of communication after a loss of AC voltage.

Tab. 7: Log data

7.2 Retrieving, saving and graphically depicting log data

There are several variants for retrieving and permanently saving the log data:

- **Variante 1:** Download the log data with a computer and display it
- **Variante 2:** Transfer log data to a solar portal and display it

Variante 1: Download the log data with a computer and display it

1. Call up Log data menu in the Webserver.
 **Ch. 6.1**
 2. Select period (max. 100 days) and confirm with Download.
- ✓ The log data (logdata.csv) can be saved onto a computer and displayed and further processed with any common program for calculating spreadsheets (e.g. Excel).

Variante 2: Transfer log data to a solar portal and display it

With a solar portal it is possible to monitor the PV system and the performance data via the Internet.

A solar portal has the following functions, which, however, may differ depending upon the portal:

- Graphic depiction of performance data
- Worldwide online access to the portal
- Email notification of errors
- Data export (e.g. Excel file)
- Long-term storage of log data

Prerequisites for data transfer to a solar portal:

- ✓ Battery inverter has Internet connection
- ✓ Registration on a solar portal (e.g. KOSTAL Solar Portal)
- ✓ Selection of a solar portal
- ✓ Activation of data transfer in the battery inverter

Activating data transfer to a solar portal via the control panel

1. Select the "Settings/information" menu on the battery inverter's control panel.
 2. Confirm with the "ENTER" key.
 3. Use the "UP", "DOWN" and "ENTER" keys to select the "Solar portal" > "Portal" menu.
 4. Select a solar portal
 5. Press and hold down the "ENTER" key.
 6. Select the "Activate" field and confirm with "ENTER".
- ✓ Data transfer to the solar portal is now enabled. The name of the solar portal is displayed. The data export to the solar portal is being executed.



INFO

A correctly set-up network connection/Internet connection is a prerequisite for data transfer

It may take as long as 20 minutes following activation (dependent upon the portal) until the data export is visible on the solar portal.

The KOSTAL Solar Portal (www.kostal-solar-portal.com) is preset as a standard solar portal.

7.3 The KOSTAL Solar Portal

The solar portal, manufactured by KOSTAL Solar Electric GmbH, is a free internet platform for monitoring PV systems.

The inverter sends the PV system's yield data and event messages to the solar portal via the internet.

The information is then stored in the solar portal. You can view and call up this information via the internet.

Prerequisites for using the solar portal

- The inverter must have a connection to the internet.
- The inverter must not yet be logged onto the solar portal.
- The inverter must not yet be assigned to a plant.

To use the solar portal, follow these two steps:

- Activate data transfer to the solar portal in the inverter. Activation can be performed using the Webserver or the inverter menu .
- Register (free of charge) on the KOSTAL Solar Electric GmbH website to use the KOSTAL Solar Portal.



INFO

If there are several inverters in a plant, data transfer to the solar portal must be set up separately for each inverter.

7.4 Remote service

The battery inverter includes smart monitoring. Should an event occur during operation, an event code for this is shown in the display.

As the operator of the system, in the event of a service call-out, you can then read out the message and obtain assistance from your installer or service partner.

By updating the software at a later date, the service team is able to directly access the battery inverter (if you enable this option) in order to analyse the error and immediately rectify it if possible.

8. External battery control

8.1	External battery control	142
8.2	External battery control via Modbus (TCP)	143
8.3	External battery control via digital inputs	145

8.1 External battery control

With external battery control, an external market operator, e.g. an energy supply company, controls the charge/discharge of the battery by means of an external energy management system.

Here, for example, the energy of the battery can be fed into the public grid as required, e.g. by the energy supply company, or charged from the public grid to stabilise it. The battery energy can of course also be used in your own house grid.

Information about the configuration of the external control can be obtained from the relevant service provider (e.g. energy supply company).

The advantage for the plant owner is that he or she receives remuneration from the external supplier for the energy provided, for example.

The external battery control can be activated and configured in the Webserver in the Service menu under Battery settings.

The following control interfaces are available:

- External battery control via Modbus (TCP)
 📄 **Ch. 8.2**
- External battery control via digital inputs
 📄 **Ch. 8.3**

External battery control without existing energy meter (KOSTAL Smart Energy Meter)

External battery control can also be carried out without a separate energy meter (KOSTAL Smart Energy Meter). In this case, the energy flow in the house cannot be measured and control of the battery is completely taken over by the external energy management.

Here, the external energy management system is responsible for compliance with the battery limits and battery protection.

8.2 External battery control via Modbus (TCP)

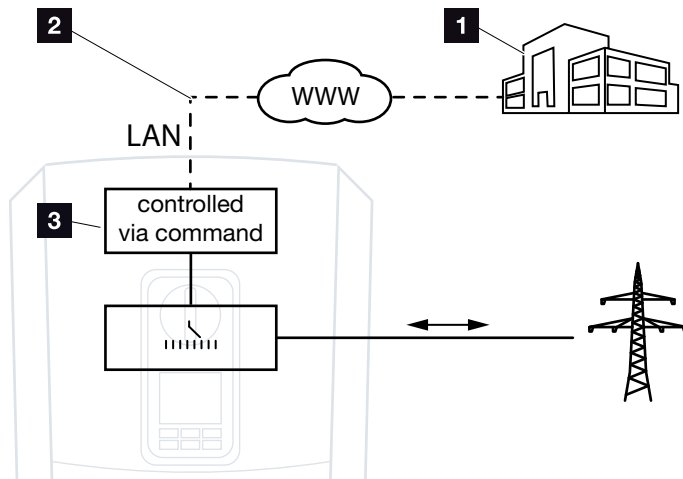

Fig. 49: External battery control via Modbus (TCP)

- 1** External energy management system (e.g. energy supply company)
- 2** Control via Modbus (TCP)
- 3** Control electronics of the battery inverter

If external battery control via Modbus (TCP) is selected, the battery inverter receives the control signals for charging and discharging the connected battery via Modbus (TCP).

For this purpose, the battery inverter must be connected to the Internet via Ethernet (LAN).



The internal energy management remains active, but is overridden by the external specifications regarding charging and discharging capacity.

The following commands are possible:

- Charging/discharging of battery via current specified as a percentage or in watts
- Charging/discharging of battery via output specified as a percentage or in watts
- Range specification of a min./max. SOC as a percentage

If external control signals are not received for a long time, the battery inverter returns to internal battery control. The time for this is set in the Webserver. The specifications of the external provider must be observed.

Activating external battery control via Modbus (TCP)

1. Connect inverter and computer.
 **Ch. 5.1**
2. Launch an Internet browser.
3. Call up the Webserver. To do this, enter the IP address of the inverter in the address line of the Internet browser and confirm with "Return". 
- The Webserver page is opened.
4. Log into the Webserver as an installer.
5. Select the "Service menu > Battery settings" menu item.
→ The "Battery settings" page opens.
6. Select the "External via protocol (Modbus TCP)" function under "Battery control".
7. Click on the "Save" button.
✓ The function is active.



INFO

The IP address can be read from the battery inverter's display.

8.3 External battery control via digital inputs

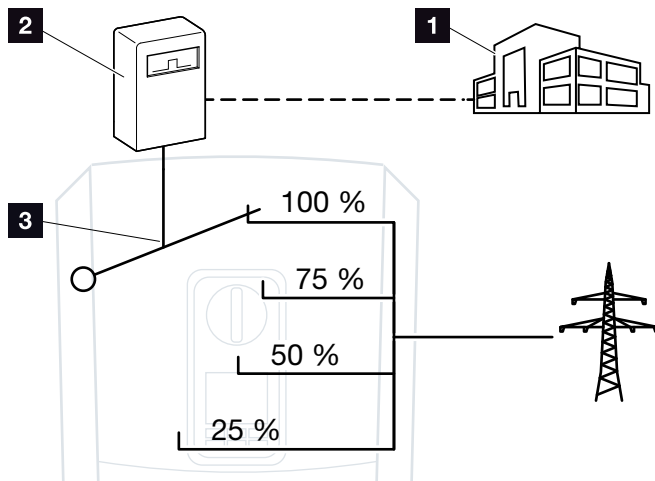

Fig. 50: External battery control via digital inputs

- 1** External energy management system (e.g. energy supply company)
- 2** External control box
- 3** Control electronics of the battery inverter

If external battery control via digital inputs is selected, the battery inverter receives the control signals for charging and discharging the connected battery via the digital inputs of the Smart Communication Board (SCB).

It is important that the digital inputs in the Webserver are configured for this purpose.



The internal energy management remains active, but is overridden by the external specifications for charging and discharging capacity.

The following commands are possible:

- Charging/discharging of battery via output specified as a percentage

The specifications of the external provider must be observed.

Activating external battery control via digital inputs

1. Connect inverter and computer.
 **Ch. 5.1**
2. Launch an Internet browser.
3. Call up the Webserver. To do this, enter the IP address of the inverter to which the control box is connected in the address line of the browser and confirm with "Return". 
- The Webserver page is opened.
4. Log into the Webserver as an installer.
5. Select the "Service menu > Battery settings" menu item.
→ The "Battery settings" page opens.
6. Select the "External via digital I/O" function under "Battery control".
7. Click on the "Save" button.
✓ The function is active.



INFO

The IP address can be read from the battery inverter's display.

Configuration of digital inputs

1. Go to "Service menu > Digital inputs".
→ The "Digital Inputs" page opens.
2. Select the "External battery management" function under "Operating mode".
3. Click on the "Save" button.
✓ The function is active.



9. Maintenance

9.1	Maintenance and cleaning	148
9.2	Housing cleaning	149
9.3	Fan cleaning	150
9.4	Updating software	154
9.5	Event codes	156

9.1 Maintenance and cleaning

Once correctly installed, the battery inverter runs virtually maintenance-free.

The following maintenance tasks are to be carried out for the battery inverter:

Activity	Interval
Check cable connections and plugs	1x annually
Clean fans  Ch. 9.3  Then carry out a fan test. The fan test can be started by going to Service menu > Fan test.	1x annually

Tab. 8: Maintenance list

If no maintenance work is carried out, this results in an exclusion of the warranty (see 'Exclusion of warranty' in our Service and warranty conditions).



DAMAGE POSSIBLE

Soiled or blocked fans mean that the battery inverter is not adequately cooled. Insufficient cooling of the battery inverter may result in reduced output or system failure.

Always mount battery inverters in such a way that falling parts cannot fall into the battery inverter through the ventilation grill.

9.2 Housing cleaning

The housing may only be wiped down with a damp cloth. Abrasive cleaners are not permitted.

9.3 Fan cleaning

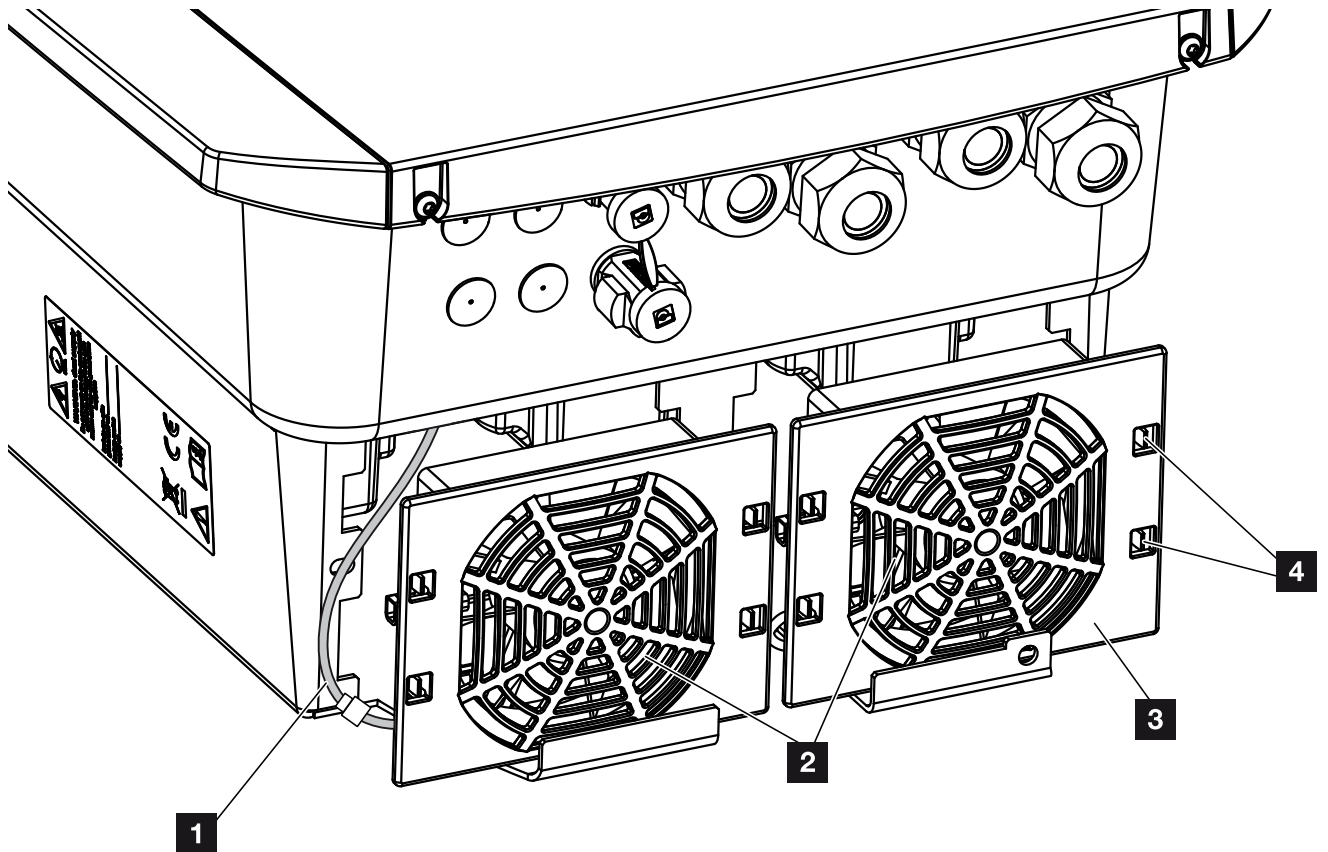

Fig. 51: Fan disassembly overview

- 1** Fan cable
- 2** Fan
- 3** Fan grill
- 4** Fastening straps

Procedure

The fan must not be removed and cleaned unless the battery inverter is switched off. Otherwise, the fan may start up.

1. Turn the DC switch on the battery inverter to OFF.

➤ Fig. 10

2. Dismantle the fan. To do this, place a screwdriver at the edge of the fan grill and apply a little pressure to the fan grill. ➤ Fig. 52

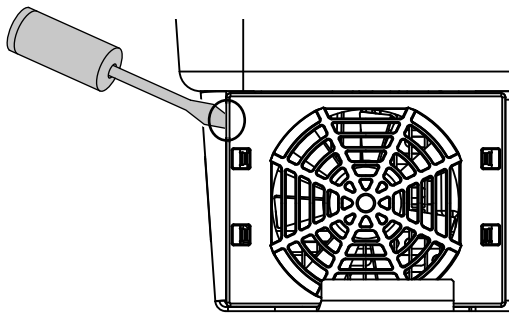

Fig. 52: Loosen fan grill

3. Press the fastening straps toward the centre of the fan with a second screwdriver.

Pull the fan unit slightly forward. ➤ Fig. 53

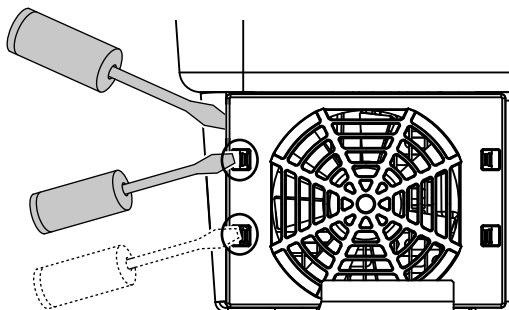



Fig. 53: Loosen fastening straps

4. Completely remove the fan unit from the housing. To do this, disconnect the plug of the fan cable.

 **Fig. 54** 

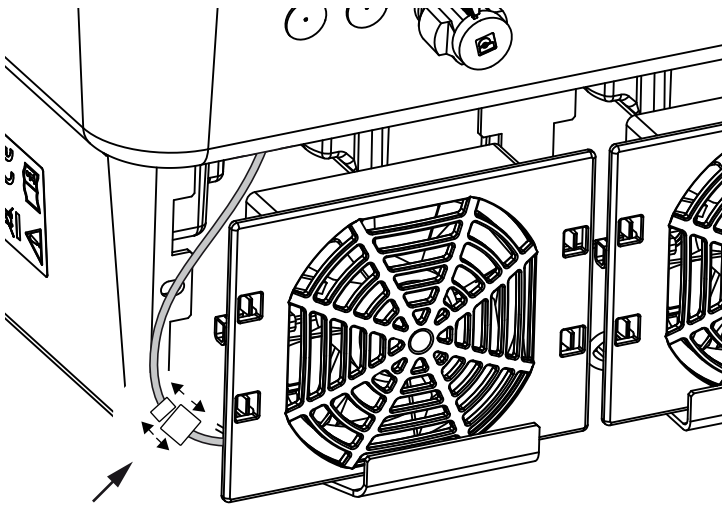

Fig. 54: Pull out fan cable

5. The fan can also be pulled off the fan grill. To do this, press the fastening straps slightly outward and pull off the fan.  **Fig. 55**

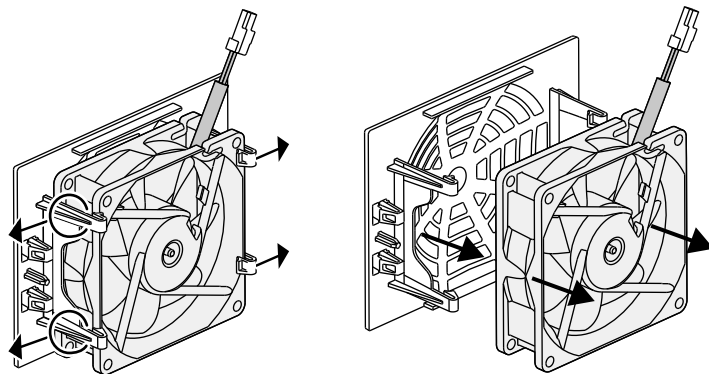

Fig. 55: Disassembly of the fan grill

6. Clean fan and housing opening with a soft brush.



**IMPORTANT
INFORMATION**

Note the cable guide inside the housing.

When installing the fan, the fan cable must be relaid in exactly the same way.

7. Note the following when installing the fan: **!**
 - the fan must be correctly installed in the fan frame (air flow direction). **↗ Fig. 56**
 - the cable must point into the housing.
 - the cable of the fan must not be jammed.

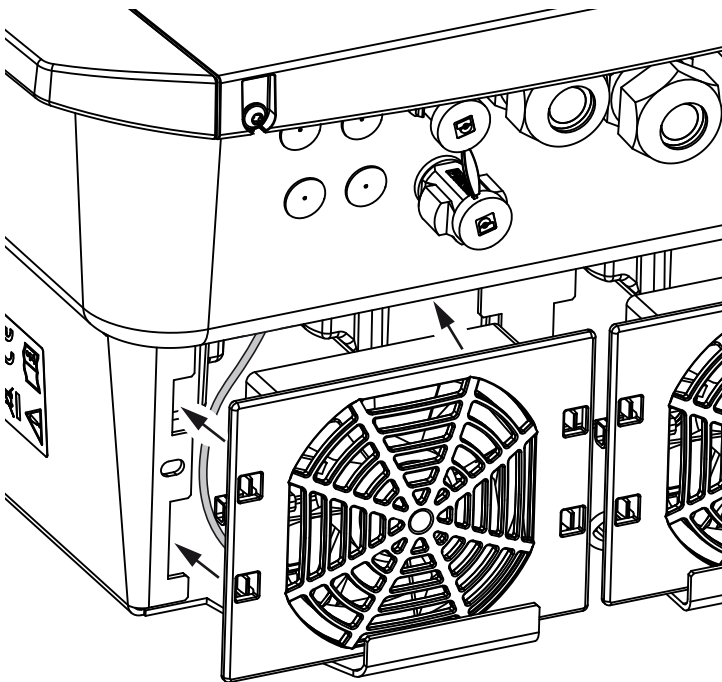

Fig. 56: Fan installation

8. Reconnect the fan cable and insert the fan into the housing. When switching on for the first time, check whether the air from the fan is drawn inwards.
9. Start up the battery inverter **↗ Ch. 4.1**



**IMPORTANT
INFORMATION**

When installing the fan ensure that the cables are laid so that they do not run into the fan. If this is not done, the fan may fail or noise may result.

9.4 Updating software

When the manufacturer updates the software, the user has the option of updating his or her version too. This brings the software and user interface (UI) of the Smart Communication Board fully up-to-date. If an update is available, you will find this on the manufacturer's website, in the download area for the product.

Procedure

- Updating using Webserverr

Updating using Webserver

Updating the battery inverter using the Webserver is a very simple process. To do this, simply select the update file (*.swu) on the computer via the Webserver and start the installation.

1. Download the update for the battery inverter from the manufacturer's website to your computer.
 2. Call up the Webserver  **Ch. 6.2**
 3. Go to "Update".
 4. Click on the "Select file" button and select the update file (*.swu) on the computer or drag the update file into the field.
 5. Start the installation using "Run".
 - The battery inverter recognises the update file and starts the installation.
 6. If you want to install the update, confirm the question with "OK".
 - The update is installed on the battery inverter. Once the update has been installed, the battery inverter is restarted. The update may take up to 10 minutes. Following the update, the successful installation is shown on the battery inverter's display.
 7. Once the update has been successfully installed, the current software version can be queried on the battery inverter or Webserver.

This is done in the battery inverter's menu by going to: Settings/information > Device information or in the Webserver by going to Info.
- ✓ The update has been installed.

9.5 Event codes

There is no need to take action when an event occurs occasionally or only briefly and the device resumes operation. When an event lasts for long periods or recurs frequently, the cause must be determined and rectified.

A list of the current event codes and measures can be found in the document "**Ereignisliste / Event list**", which can be found in the download area for your product.

10. Technical data

10.1 Technical data	158
10.2 Block diagram	162

10.1 Technical data

Subject to technical changes. Errors excepted.

You can find current information at www.kostal-solar-electric.com.

PLENTICORE BI battery inverter	Unit	5.5/13	5.5/26	10/26
Input side (DC)				
Battery inverter type		PLENTICORE BI		
Operating voltage range for battery input ($U_{DCworkbatmin} - U_{DCworkbatmax}$)	V	120...650		
Max. charging current/discharging current at battery input	A	13/13	26/26	26/26
Number of DC inputs		1		
Output side				
Rated output, $\cos \varphi = 1$ ($P_{AC,r}$)	kW	5.5	5.5	10
Max. output apparent power, $\cos \varphi_{,adj}$	kVA	5.5	5.5	10
Min. output voltage (U_{ACmin})	V	320		
Max. output voltage (U_{ACmax})	V	460		
Rated output current	A	7.94	7.94	14.43
Max. output current (I_{ACmax})	A	8.82	8.82	16.04
Switch-on current (I_{Inrush})	A	2.46	2.46	6.72
Short-circuit current (peak / RMS)	A	12.5/8.8	12.5/8.8	22.8/16.1
Number of feed-in phases		3		
Grid connection		3N~, AC, 400V		
Rated frequency (fr)	Hz	50		
Grid frequency ($f_{min} - f_{max}$)	Hz	47/53		
Setting range of the power factor $\cos \varphi_{AC,r}$		0.8...1...0.8		
Power factor for rated power ($\cos \varphi_{AC,r}$)		1		
Max. THD	%	3		
Device properties				
Standby	W	7.9		

PLENTICORE BI battery inverter	Unit	5.5/13	5.5/26	10/26
Efficiency				
Max. efficiency BATt2AC	%	96.7	96.6	96.7
Max. efficiency AC2BAT	%	96.6	96.8	96.8
System data				
Topology: Without galvanic isolation – transformerless			✓	
Protection class in accordance with IEC 60529			IP 65	
Protective class in accordance with IEC 62103			I	
Overvoltage category according to IEC 60664-1 output side (grid connection) ¹			III	
Degree of contamination ²			4	
Environmental category (indoor installation)			✓	
UV resistance			✓	
Cable diameter of AC connection cable (min-max)		8...17	8...17	8...17
Cable cross-section of AC connection cable (min-max)	mm ²	1.5...6	1.5...6	4...6
Cable cross-section of battery connection cable	mm ²	6	6	6
Torque of screws in terminal compartment	Nm	2	2	2
Torque of screws in cover	Nm	1.5	1.5	1.5
Max. fusing on output side according to IEC 60898-1		B16/C16	B16/C16	B25 / C25
Compatibility with external residual current protection devices		Type A RCD		
Internal operator protection according to EN 62109-2 (compatible with type A RCB as of FW 01.14)			✓	
Independent disconnection device according to VDE V 0126-1-1 ³			✓	
Electronic DC disconnection device integrated			✓	
Reverse polarity protection, DC-side			✓	
Height/width/depth	mm (in)	563/405/233 (22.17/15.94/9.17)		

PLENTICORE BI battery inverter	Unit	5.5/13	5.5/26	10/26
Weight	kg (lb)	19.6 (43.21)	17.9 (39.46)	19.9 (43.87)
Cooling principle – regulated fans			✓	
Max. air throughput	m ³ /h		184	
Noise emission (typical) ⁴	dB(A)		39	
Ambient temperature	°C (°F)		-20...60 (-4...140)	
Max. operating altitude above sea level	m (ft)		2000 (6562)	
Relative humidity	%		4...100	
Connection technology, DC side			SUNCLIX plug	
Connection technology, AC side			Spring-type terminal strip	
Interfaces				
Ethernet LAN (RJ45)			1	
RS485 (for battery communication)			1	
Connection of energy meter for collecting energy data (Modbus RTU)			1	
Digital inputs (e.g. for external battery management)			4	
USB 2.0			1	
Webserver (user interface)			✓	
Warranty				
Warranty following registration with the KOSTAL Solar online shop (*without registering)	Years		5 (2*)	
Warranty extension optional	Years		5/10/15	
Directives / Certification				
CE, GS, IEC62109-1, IEC62109-2, EN60529, DIN VDE 0126-1-1:2013-08, VDE AR-N4105:2018, VDE AR-N4100:2018, TOR producers, ÖNORM E8001-4-712/A2:2016, NA/EEA-CH 2014, IEC62116:2014				
(*Does not apply to all national annexes to EN 50438)				

¹ Overvoltage category III (AC output): The device is suitable for permanent connection in the grid distribution behind the meter and the line protection fuse. When the connection line travels outdoors over long distances, overvoltage protection devices may be necessary.

² Contamination degree 4: Contamination results in continuous conductivity, e.g. due to conductive dust, rain or snow; indoors or outdoors.

³ Automatic disconnection device to VDE V 0126-1-1, for Austria: The battery inverter is equipped "With automatic disconnection device in accordance with ÖVE/ÖNORM E 8001-4-712".

⁴ Measured under rated output at an ambient temperature of 23 °C. In the case of an unfavourable string connection or higher ambient temperature, the noise emission may be up to 48 dB(A).

10.2 Block diagram

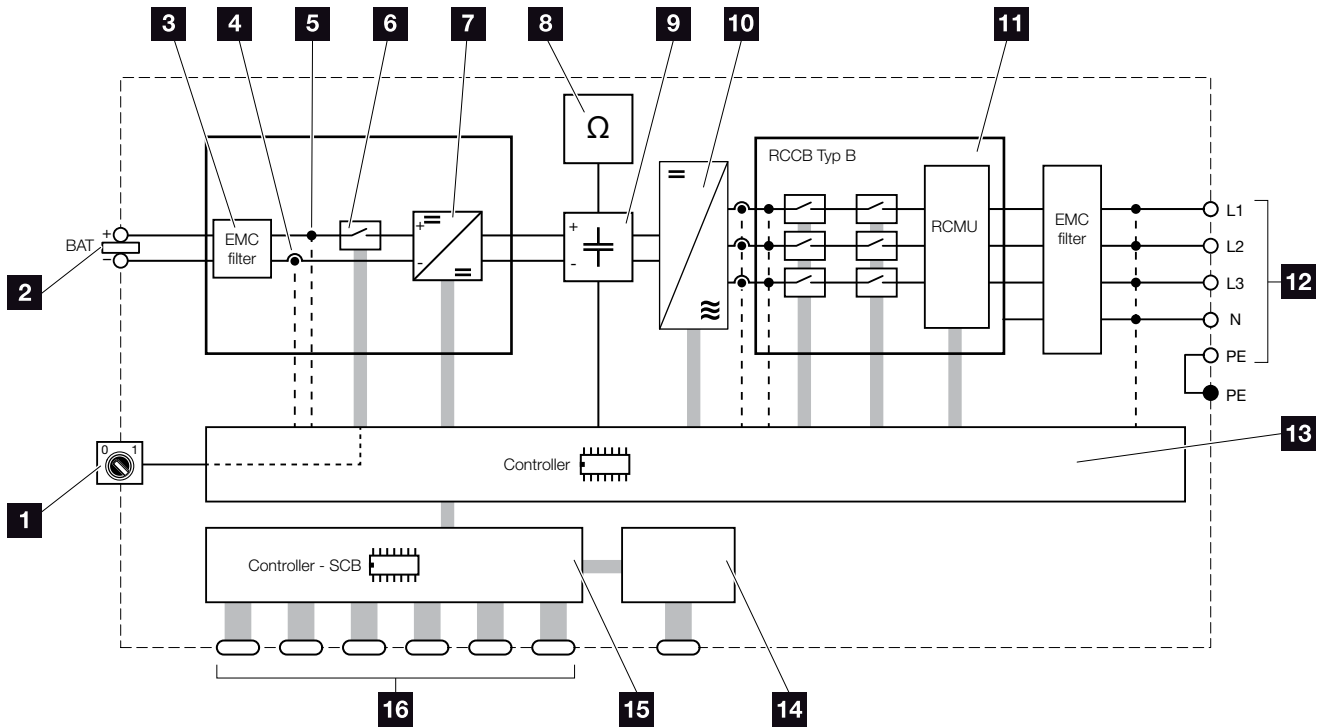

Fig. 57: Block diagram

- 1** DC switch
- 2** DC battery input
- 3** Electromagnetic compatibility (EMC) filter
- 4** Current measuring point
- 5** Voltage measuring point
- 6** Electronic DC disconnection device
- 7** DC regulator
- 8** Insulation monitoring
- 9** Intermediate circuit
- 10** Inverter bridge
- 11** Grid monitoring and shut-down
- 12** 3-phase AC output
- 13** System control
- 14** Display
- 15** Smart Communication Board (SCB)
- 16** Interfaces (e.g. Ethernet, USB, energy meter)

11. Accessories

11.1 KOSTAL Solar Portal	164
11.2 KOSTAL Solar App	165

11.1 KOSTAL Solar Portal

The KOSTAL Solar Portal allows operation of the inverters to be monitored via the Internet. You can register for the KOSTAL Solar Portal for no charge on our website.

The portal code for the KOSTAL Solar Portal (www.kostal-solar-portal.com) is P3421.

Additional information about this product is available on our website www.kostal-solar-electric.com under **Products > Tools and software > Monitoring**.

11.2 KOSTAL Solar App

The free KOSTAL Solar App provides you with a way of professionally monitoring your photovoltaic system. You can use the KOSTAL Solar App to simply and easily access all functions on your smartphone or tablet at any time.

To set up and use the app, you will need access to the KOSTAL Solar Portal and to have an inverter set up there. The same access data used for the KOSTAL Solar Portal is required to log into the app.

You can use the KOSTAL Solar App to easily monitor your photovoltaic system and to display relevant system data both when you are out and about and at home. It allows you to access the consumption and generation data over various time periods, such as day, week, month and year, and to access the historical data of your photovoltaic system. So you are always up-to-date with the KOSTAL Solar App.

Download the free KOSTAL Solar App today and benefit from new and advanced functionalities.

Additional information about this product is available on our website www.kostal-solar-electric.com under **Products > Tools and software > Monitoring**.

12. Appendix

12.1 Type plate	167
12.2 Warranty and service	168
12.3 Handover to the operator	169
12.4 Decommissioning and disposal	170

12.1 Type plate

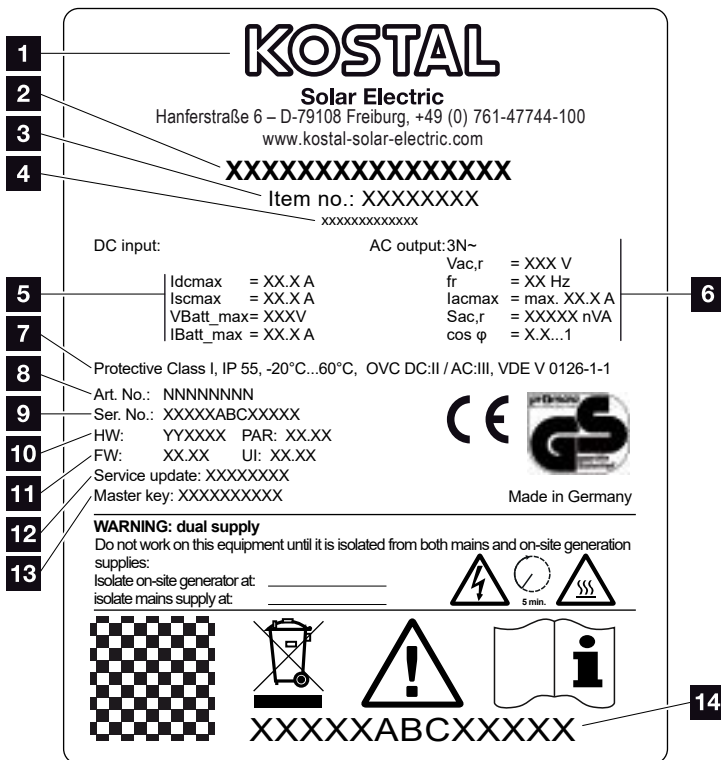

Fig. 58: Type plate

The type plate is located on the battery inverter. You will find the device type and the most important technical data listed on the type plate.

- 1** Name and address of manufacturer
- 2** Device type
- 3** Article number
- 4** Additional designation (e.g. service device)
- 5** Details of the DC input:
 - max. DC input current
 - max. DC short circuit current
 - max. DC input voltage for battery
 - max. DC input current for battery
- 6** Details of the AC output:
 - number of feed-in phases
 - output voltage (nominal)
 - grid frequency
 - max. AC output current
 - max. AC power
 - setting range of power factor
- 7** Protective class in accordance with IEC 62103, protection class, ambient temperature range, overvoltage category, requirements with which the integrated grid monitoring complies
- 8** Internal article number
- 9** Serial number
- 10** Version number of hardware, version number of parameter set
- 11** Version number of the firmware, version number of the user interface of the device
- 12** Date of last update (only for service devices)
- 13** Master key password for installer's Webserver login
- 14** Removable warranty label

12.2 Warranty and service

The warranty period for the battery inverter is 2 years from the date of purchase. If you register the battery inverter with the KOSTAL Solar online shop within the first 6 months of the date of purchase, you can extend this free of charge to our KOSTAL 5 year Smart Warranty.

More information about the service and warranty conditions for your battery inverter is available from the download area for the product on our website at www.kostal-solar-electric.com.

For service information and a possible subsequent shipment of parts, we require your device type and the serial number. You will find this information on the type plate on the exterior of the housing.

If parts are required, use only original replacement parts.

If you have any technical questions, please call our service hotline:

- Germany and other countries¹
+49 (0)761 477 44 - 222
- Switzerland
+41 32 5800 225
- France, Belgium, Luxembourg
+33 16138 4117
- Greece
+30 2310 477 555
- Italy
+39 011 97 82 420
- Spain, Portugal²
+34 961 824 927

¹ Language: German, English

² Language: Spanish, English



12.3 Handover to the operator

Following successful installation and commissioning, all documents are to be handed over to the operator. The operator must be made aware of the following points:

- Position and function of the DC switch
- Position and function of the AC line circuit breaker
- Safety when handling the device
- Appropriate procedure when checking and servicing the unit
- Meaning of the LEDs and the display messages
- Contact person in the event of a fault
- The provision of system and inspection documentation in accordance with DIN EN 62446 (VDE 0126-23) (optional).

12.4 Decommissioning and disposal

To disassemble the battery inverter, proceed as follows:

1. De-energise battery inverter on AC and DC side.
 **Ch. 4.3** 
2. Open cover of battery inverter.
3. Loosen terminals and cable glands.
4. Remove all DC and AC lines and communication cables.
5. Close cover of battery inverter.
6. Loosen screw underneath the battery inverter.
7. Loosen screws on top of the battery inverter.
8. Lift battery inverter off the wall.

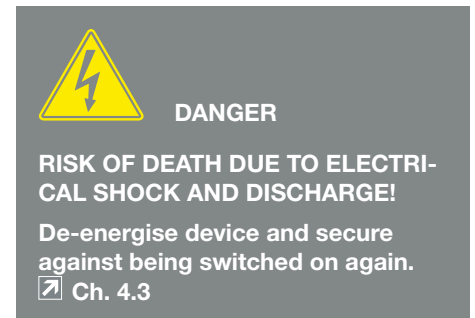

Proper disposal

Electronic equipment labelled with a dustbin with a line through it may not be disposed of with household waste. This equipment can be handed in to waste collection points free of charge.



Find out about the local requirements for the separate collection of electrical and electronic equipment in your country.

Index

A

Accessories 163

B

Battery configuration 115

Battery usage 117

Battery use strategy 118, 130

Block diagram 162

C

Cable 160

Calling up Webserver 98

Control buttons 26

Current operating manual 12

D

Data export 137, 138

DC cables 57, 170

DC connections 68

DC switch 23, 59, 65, 66, 67, 151, 162

DHCP server 114

Display 41, 59, 69, 70, 71, 72

Disposal 170

E

EMS 28

Ethernet 51, 52, 91, 92, 93

Ethernet cable 93

EU declarations of conformity 11

F

Faults 135

Firmware 167

G

Grid monitoring 135, 167

H

Hotline 7, 168

I

Initial commissioning.....59
Inputs..... 158
Interfaces..... 160
IP address 90, 99, 114, 144, 146

L

LAN..... 90
Language 2
Line circuit breaker 43, 59, 65, 67
Log data..... 111, 133, 136, 137

M

Menu..... 70, 81

N

Notes 12, 14, 17

O

Open the inverter cover 91, 93, 170
Operation 70
Operational statuses..... 72

P

Proper use..... 8
Proxy server 90

R

Ripple control receiver 112

S

Safety instructions 14

Saving interval 33

Scope of delivery 39

Self-consumption 135

Settings 26, 69, 79, 90, 93, 99, 138

Sleep mode 130, 131

Solar portal 137

Spring-loaded terminal strips 46

Storage 38

Strings 135

T

Technical data 158

Terminal 45

Transport 38

Type plate 167, 168

W

Wall mount 42

Warnings 15

Warranty 9, 168

Webserver 32, 91, 96, 97, 98, 112

KOSTAL

KOSTAL Solar Electric GmbH
Hanferstr. 6
79108 Freiburg i. Br.
Germany
Telephone: +49 761 47744 - 100
Fax: +49 761 47744 - 111

KOSTAL Solar Electric Ibérica S.L.
Edificio abm
Ronda Narciso Monturiol y Estarriol, 3
Torre B, despachos 2 y 3
Parque Tecnológico de Valencia
46980 Valencia
España
Teléfono: +34 961 824 - 934
Fax: +34 961 824 - 931

KOSTAL Solar Electric France SARL
11, rue Jacques Cartier
78280 Guyancourt
France
Téléphone: +33 1 61 38 - 4117
Fax: +33 1 61 38 - 3940

KOSTAL Solar Electric Hellas E.Π.Ε.
47 Steliou Kazantzidi st., P.O. Box: 60080
1st building – 2nd entrance
55535, Pilea, Thessaloniki
Ελλάδα
Τηλέφωνο: +30 2310 477 - 550
Φαξ: +30 2310 477 - 551

KOSTAL Solar Electric Italia Srl
Via Genova, 57
10098 Rivoli (TO)
Italia
Telefono: +39 011 97 82 - 420
Fax: +39 011 97 82 - 432

www.kostal-solar-electric.com