

## Installation environment



Max. +50°C



Min. -10°C



RH. +5%~+95%

## Installation tools



## System size

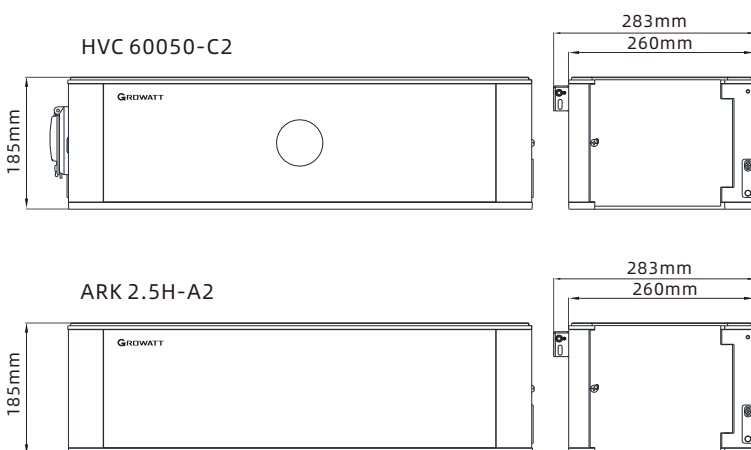

## 1. Check

### 1-1 Check HVC60050-C2 List

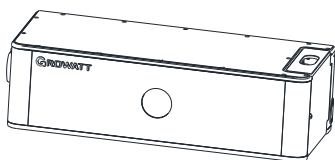

HVC60050-C2 X1

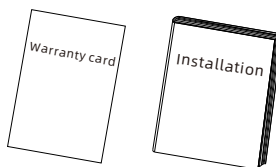

Warranty card X1  
Quick installation Manual X1

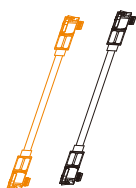

Power cable ( to battery) X1

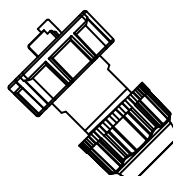

Plug X1

## 1-2 Check ARK 2.5H-A2 List

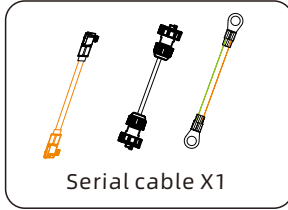
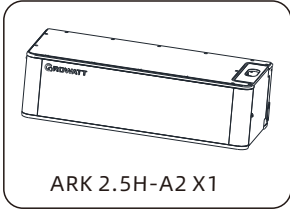

## 1-3 Check accessories

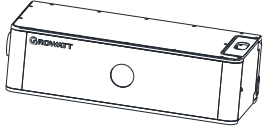

A

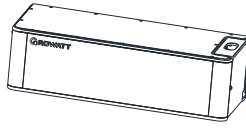

B

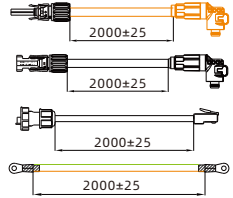

C

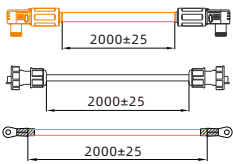

D

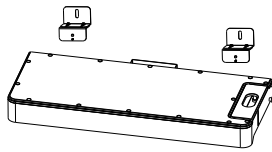

E

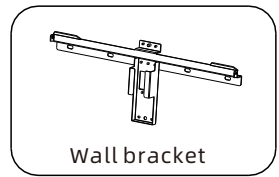

F

Installation Method	Compound Mode
Standard Wall-Mounted Installation	A+B+C+F*n
Standard floor installation	A+B+C+E
Wall-Mounted Battery system stacked in two line	A+B+C+D+F*n
Floor installation battery system stacked in two line	A+B+C+D+E*2

**Note:** Wall mounted, one battery with one Wall bracket.

## 2. Floor installation with base

### 2-1 Installation Location Requirements

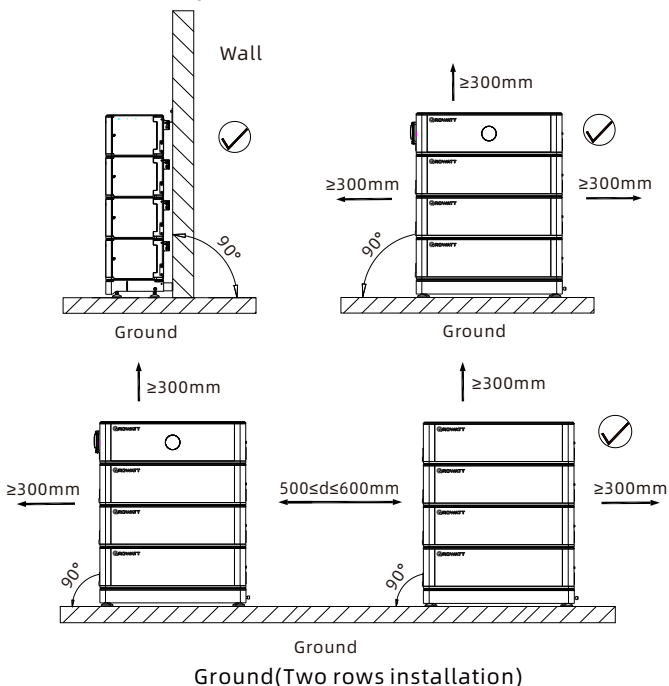

#### **Note:**

1. If more than 4 batteries are used, base mounting is recommended.
2. For floor installation with base., the maximum stack number of the battery is ten. But if the battery number is greater than six, we recommend stacking them in two lines.

## 2-2 Installation Procedure

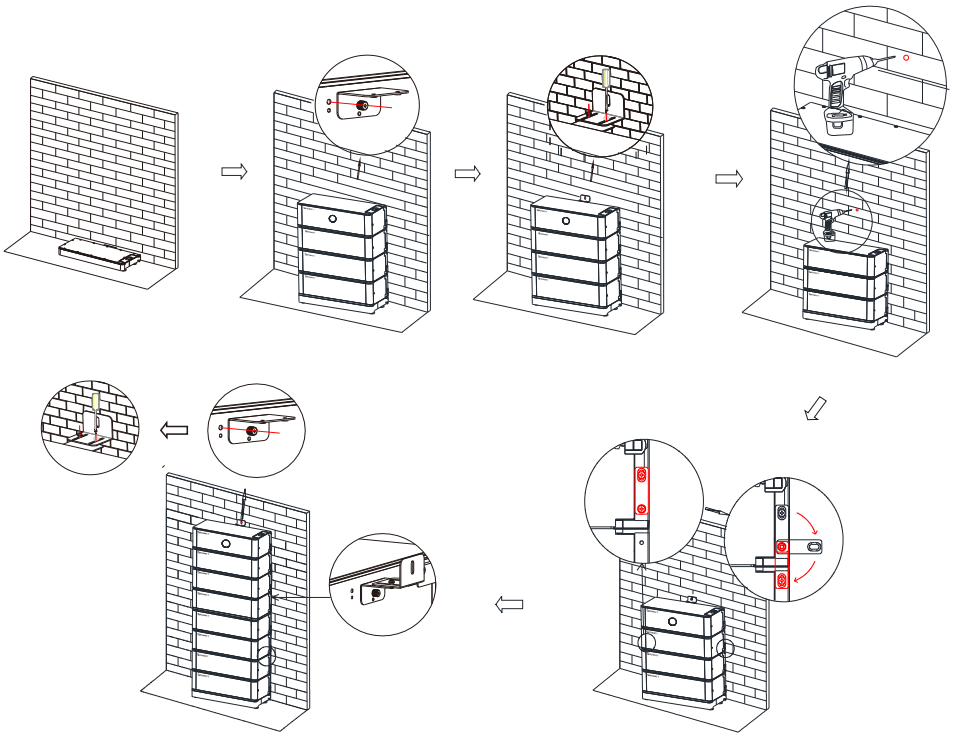

**Note:** The safety part needs to be installed at the top battery, however, once the number of the battery pack is higher than 7, one more safety part should be installed in the middle battery which is shown the last step.

## 3. Wall-Mounted Installation Process

### 3-1 Installation Location Requirements

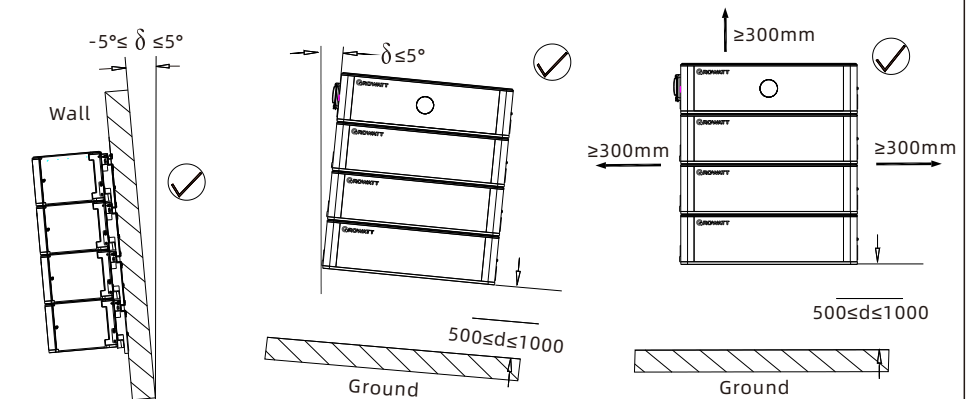

**Note:** The number of wall-mount installations should not exceed four. Please make sure that the weight capacity of wall should exceed 150kg.

### 3-2 Installation Procedure

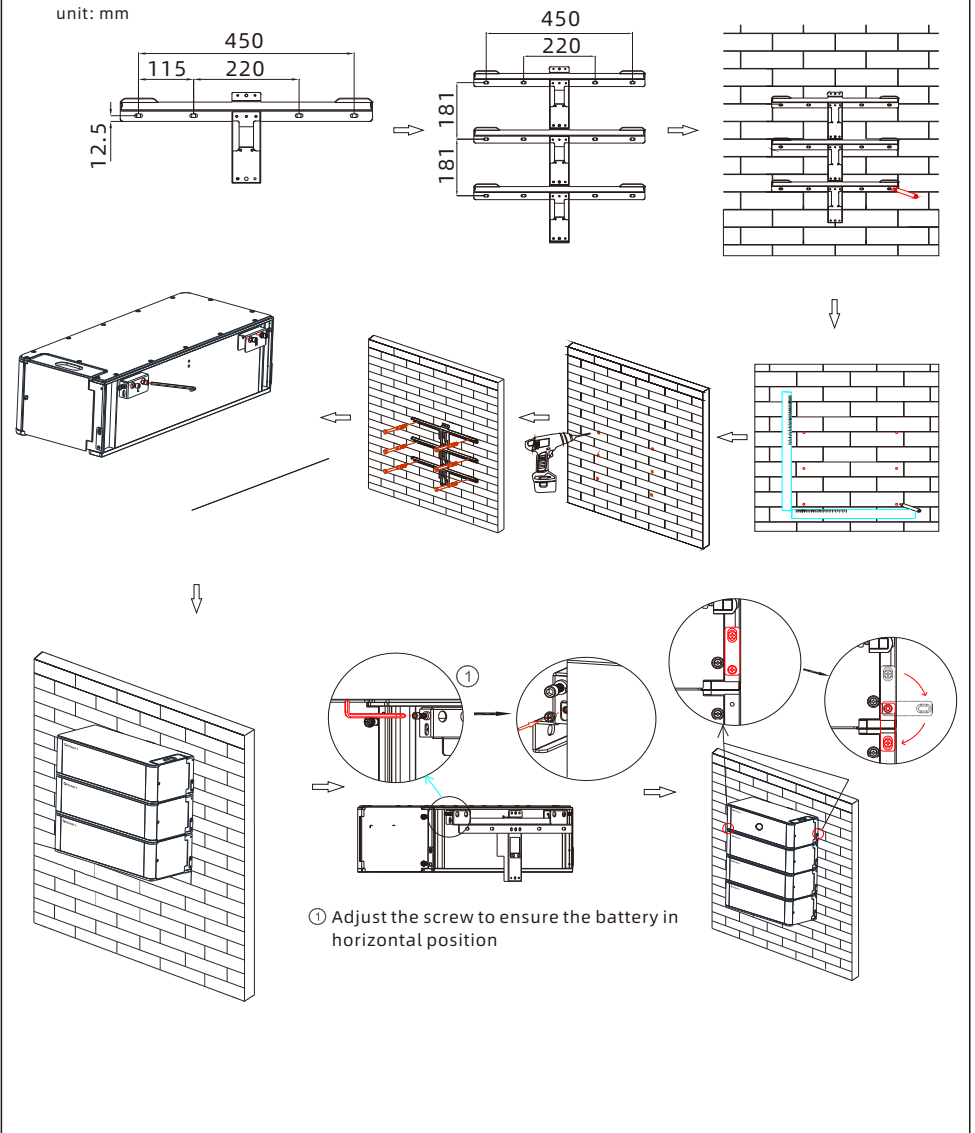

### 4. Install Environment

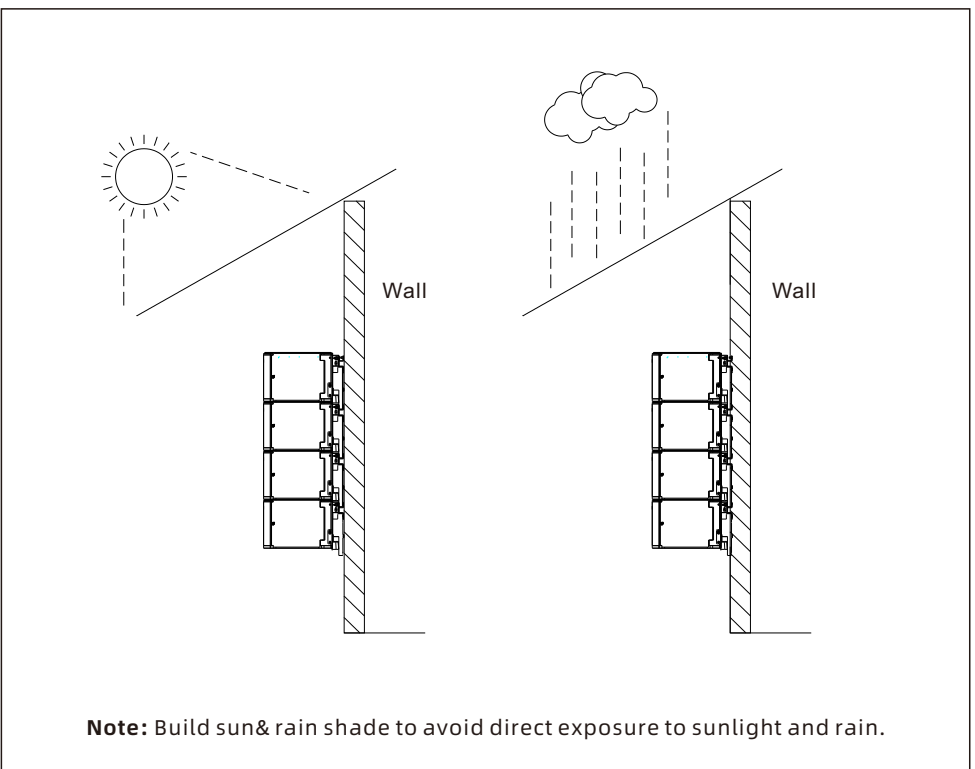

## 5. Wire Connection

### 5-1 HVC 60050-C2 Interface introduction

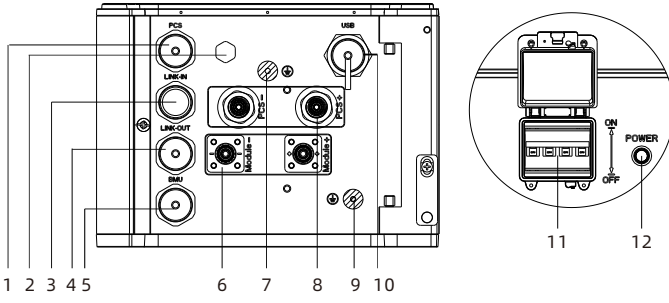

1	Communication with PCS	7	Ground terminal
2	Pressure relief valve	8	Terminal connected to PCS
3	Parallel communication input	9	Ground terminal
4	Parallel communication output	10	USB interface
5	Communication with battery	11	Breaker
6	Terminal connected to battery	12	Power button

### 5-2 ARK 2.5H-A2 Connection end face introduction

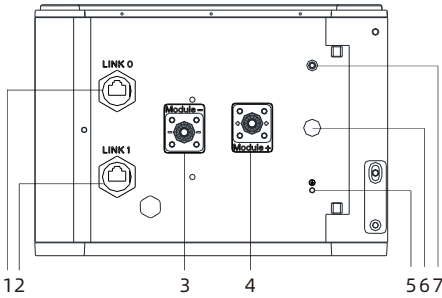

1	Communication input	5	Ground terminal
2	Communication output	6	Pressure relief valve
3	Module negative terminal	7	Ground terminal
4	Module positive terminal		

### 5-3 Diagram of wiring connection

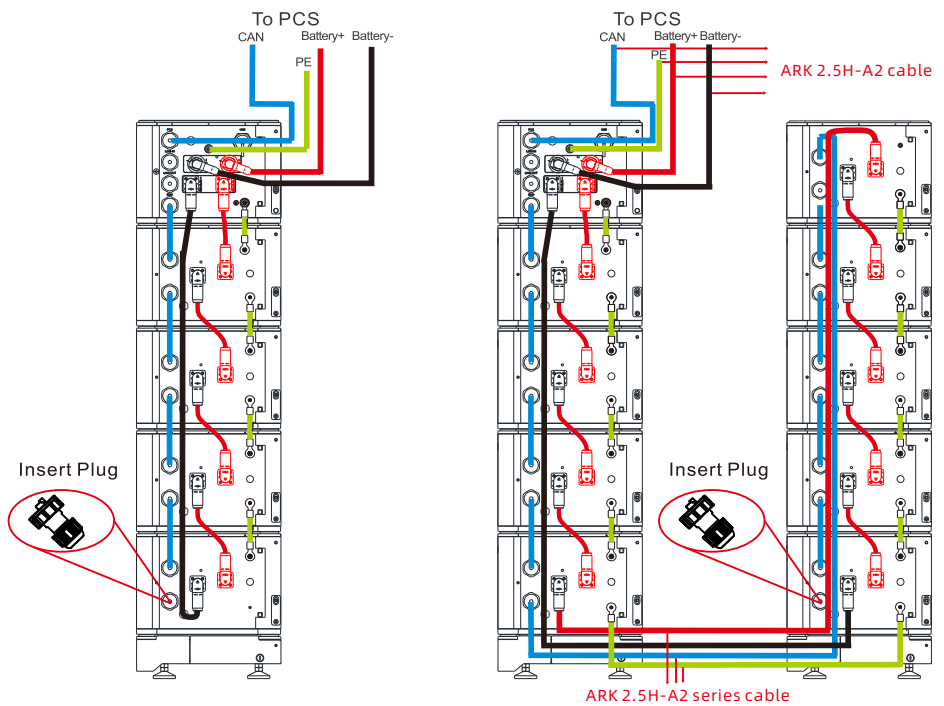

#### Note:

- Before installing the system, ensure that the voltage difference of the battery pack is less than 0.5V;
- For the same system, it is recommended to select the battery with the manufacturing date difference within 3 months, otherwise the system capacity will be limited.
- If there is a switch between PCS and battery, it is recommended to use a circuit breaker with rated voltage greater than 750V and rated current greater than 63A.

## 6. Terminal Connection

### 6-1 Power terminal

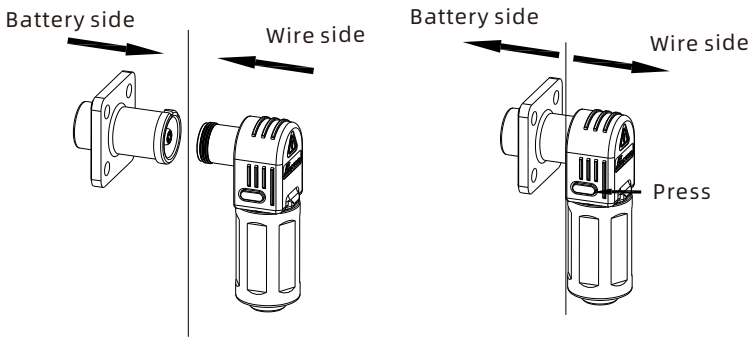

**Note:** Press the position indicated in the figure above before disconnecting the power terminal.

### 6-2 Communication terminal

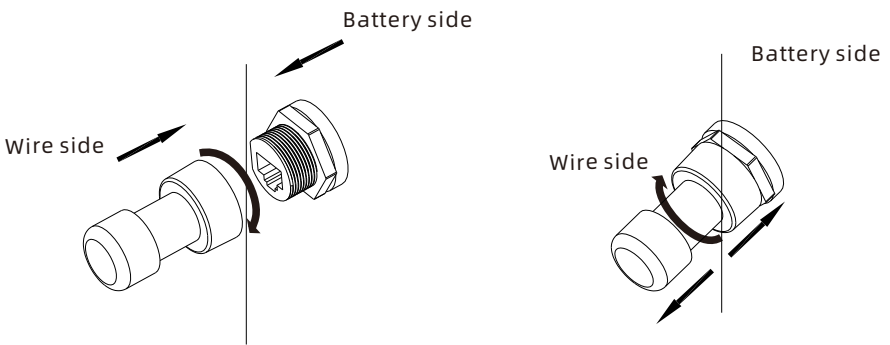

## 7. Battery system switch operation

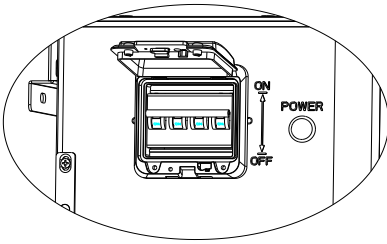

Power ON battery system

a、 Power on battery system:  
Turn the circuit breaker to the "on" state,  
then press the "POWER" button for 5-6 seconds,  
and wait until the LED of the battery system lights up,  
indicating that the power on is completed

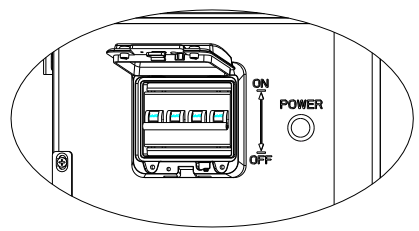

Power OFF battery system

b、 Power off battery system:  
Turn the circuit breaker to "off" to  
turn off the entire battery system

## 8. Service and contact

### Shenzhen Growatt New Energy Co., Ltd.

4-13/F, Building A, Sino-German (Europe) Industrial Park,  
Hangcheng Blvd, Bao'an District, Shenzhen, China

T +86 755 2747 1942  
E service@ginverter.com  
W en.growatt.com



Download  
Manual



Growatt New Energy

GR-UM-411-A-00 (PN:044.0125100)