

BENNING



Installation Tester

BENNING IT 130

Operating Manual

Manufacturer:

BENNING Elektrotechnik und Elektronik GmbH & Co. KG

Münsterstraße 135 - 137

D - 46397 Bocholt

Phone: +49 (0) 2871 - 93 - 0 • Fax: +49 (0) 2871 - 93 - 429

www.benning.de • duspol@benning.de



This symbol on your device ensures that the device complies with the requirements laid down by the EU (European Union) with regard to safety and electromagnetic compatibility of devices.

© 05/2020 BENNING

This document must not be reproduced or used in any other form without the express written consent of BENNING.

IDNo. 20 752 249

Part no.: 10110213.06

Table of contents

1	Preface	6
2	Safety and operating instructions	7
2.1	Warnings.....	7
2.2	Batteries / storage batteries and charger.....	11
2.3	Standards applied	13
3	Device description	14
3.1	Front panel.....	14
3.2	Connection panel	15
3.3	Rear panel	16
3.4	Carrying the installation tester	17
3.4.1	<i>Attachment of the carrying strap</i>	18
3.5	Scope of delivery and optional accessories.....	19
3.5.1	<i>Standard scope of delivery</i>	19
3.5.2	<i>Optional accessories</i>	20
4	Operating the BENNING IT 130 installation tester	21
4.1	Indications and acoustic warning signals.....	21
4.1.1	<i>Connection monitor</i>	21
4.1.2	<i>Battery indication</i>	21
4.1.3	<i>Warnings and messages</i>	21
4.1.4	<i>Evaluation field</i>	22
4.1.5	<i>Acoustic warning signals</i>	22
4.1.6	<i>Help menu ("HELP" key)</i>	23
4.1.7	<i>Background lighting and contrast</i>	23
4.2	Function selector switch	24
4.3	"AUTO" mode.....	24
4.4	"SETTINGS" mode.....	25
4.4.1	<i>Memory</i>	25
4.4.2	<i>Language</i>	25
4.4.3	<i>Date and time</i>	26
4.4.4	<i>Earthing system (power supply network)</i>	26
4.4.5	<i>RCD testing</i>	27
4.4.6	<i>Isc factor (scaling factor)</i>	28
4.4.7	<i>Commander ON/OFF</i>	29
4.4.8	<i>Initial settings</i>	29
4.4.9	<i>Clamp settings</i>	30
5	Measurements	32
5.1	TRMS voltage, frequency and phase sequence	32
5.2	Insulating resistance.....	34
5.3	Low-impedance resistance / continuity test	36
5.3.1	<i>Low-impedance resistance with a testing current of 200 mA</i>	36
5.3.2	<i>Continuity test with a testing current of 7 mA</i>	37
5.3.3	<i>Compensation (null balance) of the test cable resistance</i>	38
5.4	RCD testing.....	40
5.4.1	<i>Contact voltage (U_c)</i>	41
5.4.2	<i>Tripping time (RCDt)</i>	42
5.4.3	<i>Tripping current (RCD I)</i>	42
5.4.4	<i>Automatic test</i>	43

5.5	Loop impedance and prospective short-circuit current.....	46
5.6	Line impedance and prospective short-circuit current / voltage drop.....	48
5.6.1	<i>Line impedance and prospective short-circuit current</i>	49
5.6.2	<i>Voltage drop</i>	50
5.7	Earthing resistance	52
5.8	Testing the protective conductor connection (PE)	54
5.9	TRMS current by means of current clamp adapter	56
5.10	Single-fault leakage current (ISFL) in IT networks	57
5.11	Luminous intensity	59
6	Management of measured values	61
6.1	Memory structure	61
6.2	Saving measuring results	63
6.3	Recalling measuring results	64
6.4	Deleting measuring results	65
6.4.1	<i>Deleting the entire measured value memory</i>	65
6.4.2	<i>Deleting all measurements of each storage location and subordinate storage locations</i>	65
6.4.3	<i>Deleting an individual measurement</i>	66
6.5	Renaming installation structure fields	67
6.5.1	<i>Renaming installation structure fields by means of the PC software</i>	67
6.5.2	<i>Renaming the installation structure fields by means of the barcode scanner</i>	67
6.6	USB and RS232 interface	68
7	Maintenance	69
7.1	Fuse replacement	69
7.2	Cleaning.....	69
7.3	Periodic calibration.....	69
7.4	Service.....	70
8	Technical data	71
8.1	Insulating resistance.....	71
8.2	Low-impedance resistance / continuity test	72
8.2.1	<i>Low-impedance resistance R LOW</i>	72
8.2.2	<i>Continuity test</i>	72
8.3	Residual current protection devices (RCDs).....	73
8.3.1	<i>General data</i>	73
8.3.2	<i>Contact voltage (U_c)</i>	74
8.3.3	<i>Tripping time (RCD t)</i>	74
8.3.4	<i>Tripping current (RCD I)</i>	74
8.4	Loop impedance and prospective short-circuit current.....	76
8.4.1	<i>Z_s function (for systems without RCD)</i>	76
8.4.2	<i>Z_srcd function (for systems with RCD)</i>	76
8.5	Line impedance and prospective short-circuit current / voltage drop	77
8.6	Earthing resistance	78
8.7	TRMS voltage, frequency and phase sequence	78
8.7.1	<i>TRMS voltage (AC/DC)</i>	78
8.7.2	<i>Voltage of the connection monitor</i>	78
8.7.3	<i>Frequency</i>	78
8.7.4	<i>Phase sequence (rotary field)</i>	78
8.8	TRMS current (AC / DC) via current clamp adapter.....	79
8.9	Single-fault leakage current (ISFL) in IT networks	79
8.10	Luminous intensity	80
8.11	General data	81

Appendix A	Fuse table – Prospective short-circuit current	82
Appendix B	Standard and optional accessories for specific measuring functions	85
Appendix C	"Commander" test probe, "Commander" test plug.....	86
C.1	 Safety warnings	86
C.2	Batteries.....	86
C.3	Description of the "Commanders".....	87
C.4	LED indications of the "Commanders".....	88

1 Preface

BENNING would like to congratulate you on purchasing this BENNING IT 130 installation tester and its accessories. The BENNING IT 130 installation tester is a multifunctional tester for testing electrical installations in compliance with IEC 60364-6 (DIN VDE 0100-600) and EN 50110 (DIN VDE 0105-100).

The device is intended for the following measurements and tests:

- ❑ TRUE RMS voltage, frequency and rotary field (phase sequence)
- ❑ low-impedance resistance, continuity test
- ❑ insulating resistance
- ❑ residual current protection devices (RCD)
- ❑ loop impedance without RCD tripping
- ❑ line impedance and voltage drop
- ❑ TRUE RMS current by means of optional current clamp adapters
- ❑ earthing resistance by means of optional earthing kit
- ❑ luminous intensity by means of optional luxmeter
- ❑ single-fault leakage current in IT networks

The graphic display with background lighting allows easy reading of measuring results, indications, measuring parameters and messages. Two "PASS" / "FAIL" indications (red / green LEDs) are located next to the LC display.

The BENNING IT 130 installation tester is equipped with all accessories necessary for comfortable testing. It is kept in a padded carrying case together with all accessories.

2 Safety and operating instructions

The following symbols are used both in the operating manual and on the installation tester:



Attention! Danger! Please observe the operating manual!



Warning of dangerous voltage!



Protection class II



Earth (voltage to earth)

2.1 Warnings

In order to ensure a high degree of operational safety during the tests and measurements and to avoid damaging of the BENNING IT 130 installation tester, the general warnings listed in the following must be adhered to.



Warnings – general information:

- In case the installation tester is not used according to this operating manual, the protection provided by the installation tester might be impaired!**
- Please read this operating manual carefully, because otherwise the use of the installation tester might involve dangers for the user, the installation tester or the test object!**
- Never use the installation tester or the corresponding accessories, if they exhibit visible damages!**
- Absolutely observe all general safety instructions in order to avoid the risk of an electric shock when handling dangerous voltages!**
- If the fuse F1 has blown, please follow the instructions of this operating manual to replace it! Only use a fuse complying with the specification (see chapter 7.1) as replacement.**
If one of the fuses F2 or F3 has blown, the device must not be used anymore. In this case, the device must be sent to BENNING for inspection and repair.
- Never use the installation tester in AC supply systems with voltages higher than 550 V AC.**
- Any service, repair or adjustments of the installation tester and of the corresponding accessories must be carried out by authorized qualified personnel only!**
- Please use standard or optional BENNING accessories only which are available from your authorized specialty retailer!**

- ❑ Please observe that the measuring category of some accessories might be lower than that of the installation tester. Test probes and "Commander" test probes are provided with detachable protective caps. If these attachable protective caps are removed, the measuring category will be reduced to CAT II. Please check the markings of the accessories!
without attachable protective cap, 18 mm tip: CAT II 1000 V to earth
with attachable protective cap, 4 mm tip: CAT II 1000 V / CAT III 600 V /
CAT IV 300 V to earth
- ❑ The installation tester comes with rechargeable NiMh storage batteries. The storage batteries must be replaced only as shown on the label at the battery compartment cover or as described in this operating manual and must be replaced with storage batteries of the same type only. Do not use standard alkaline batteries while the charger is connected, because otherwise these batteries might explode!
- ❑ Dangerous voltages are applied to the interior of the device! Disconnect all test cables, disconnect the charger and switch off the installation tester before opening the cover of the battery / fuse compartment.
- ❑ Do not connect any voltage source to the C1 input. This input must be used for connection of the current clamp adapters only. The maximum input voltage is 3 V!
- ❑ Absolutely observe all common safety instructions in order to avoid the risk of an electric shock when working on electrical installations!



Warnings with regard to measurements:

Insulating resistance

- ❑ Measurements of the insulating resistance must be carried out only at test objects which are free of voltage!
- ❑ Never touch the test object during measurement before it is completely discharged! Danger of life-threatening electric shocks!
- ❑ If the insulating resistance is measured on capacitive test objects, discharging might take place time-delayed! During discharge, the warning  as well as the current voltage (Udisch) are displayed until the voltage falls below 30 V.
- ❑ Do not connect any measuring input to an external voltage higher than 550 V (AC or DC) in order not to damage the installation tester!

Low-impedance measurement / continuity test

- ❑ Low-impedance measurements / continuity tests must be carried out on discharged test objects only!
- ❑ The test result might be influenced by parallel impedances.

Testing the PE connection

- ❑ If a phase voltage is detected at the PE connection, immediately stop all measurements. Make sure that the error in the installation is eliminated before going on with the measurements!

Remarks with regard to measurements:**General**

- ❑ The  icon means that the selected measurement cannot be carried out due to irregular conditions at the input terminals.
- ❑ Carry out measurements of the insulating resistance, low-impedance resistance, continuity and earthing resistance on discharged objects only!
- ❑ The "PASS" / "FAIL" indication is activated, if a limiting value has been defined. Choose appropriate limiting values for evaluating the measuring results.
- ❑ If only two of the three test cables are connected to the electrical installation to be tested, only the voltage value between those two test cables shall be valid.

Insulating resistance

- ❑ The three-wire test cable as well as the "Commander" test probe can be used for measuring the insulating resistance.
- ❑ If a voltage higher than 30 V (AC or DC) is measured at the testing terminals, the measurement of the insulating resistance cannot be carried out.
- ❑ The installation tester automatically discharges test objects after the measurement is finished.
- ❑ Double-click the "TEST" key to carry out a continuous measurement.

Low-impedance measurement / continuity test

- ❑ If a voltage higher than 10 V (AC or DC) is measured at the testing terminals, the low-impedance measurement / continuity test cannot be carried out.
- ❑ Before carrying out a low-impedance measurement / continuity test, compensate the test cable resistance (if necessary).

Earthing resistance

- ❑ If a voltage higher than 30 V (AC or DC) is measured at the testing terminals, the measurement of the earthing resistance cannot be carried out.
- ❑ If an interference voltage higher than 5 V is detected at the testing terminals H and E or S, the warning symbol "⚡" will be displayed indicating that the measuring result might have been influenced!

Residual current protection devices (RCDs)

- ❑ The parameters set for a measuring function will be taken over for other RCD measurements as well!
- ❑ Contact voltage measurement usually does not involve any tripping of the residual current protection devices (RCD). However, the tripping threshold might be exceeded due to leakage currents via the protective conductor (PE) or via capacitive connections between the conductors L and PE.
- ❑ Compared to the loop impedance R_L (contact voltage subresult), the measurement of the loop impedance Z_{sRCD} needs more time, but offers a considerably higher degree of accuracy.
- ❑ The tripping time and tripping current measurement is only carried out, if the contact voltage at nominal differential current is lower than the preset limiting value of the contact voltage.
- ❑ The automatic test sequence (RCD AUTO function) is stopped, if the tripping time is outside the admissible value.

Loop impedance

- ❑ The lower limiting value of the prospective short-circuit current depends on the fuse type, on the fuse current rating and tripping time as well as on the I_{sc} scaling factor.
- ❑ The stated accuracy of the parameters tested shall only apply, if the mains voltage is stable during measurement.
- ❑ Loop impedance measurements (Z_s) involve tripping of residual current protection devices (RCDs).
- ❑ Loop impedance measurements (Z_{sRCD}) normally do not involve tripping of the residual current protection device (RCD). However, the tripping threshold might be exceeded due to leakage currents flowing to the protective conductor (PE) or via the capacitive connection between the conductors L and PE.

Line impedance / voltage drop

- ❑ During phase-to-phase measurements of the line impedance $Z_l(L-L)$ with the test cables PE and N being connected, a warning of dangerous PE voltages is displayed. However, the measurement will be carried out.
- ❑ The stated accuracy of the parameters tested shall only apply, if the mains voltage is stable during measurement.
- ❑ Depending on the connection voltage detected, the test terminals L and N are inverted automatically.

Luminous intensity

- ❑ Shadows and irregular exposure to light might influence the measuring result!
- ❑ Artificial light sources reach their full capacity (see Technical Data of the light sources) only after a certain time and therefore should be switched on until they reach this capacity before carrying out measurements.

Testing the protective conductor connection (PE)

- ❑ The PE connection can be tested only in switch positions "FI/RCD", " $Z_s(L-PE)$ " and " $Z_l(L-N/L)$ "!
- ❑ For correct measurement of the PE connection, the "TEST" key must be touched for several seconds.
- ❑ Make sure not to stand on an insulated floor, because otherwise the test result might be incorrect!

2.2 Batteries / storage batteries and charger

The installation tester can be operated with six alkaline batteries (type AA) or with rechargeable NiMh batteries (storage batteries). The specified operating time refers to storage batteries with a nominal capacity of 2100 mAh. The batteries' state of charge is permanently displayed in the lower right part of the LC display. If the battery voltage is too low, this will be displayed as shown in figure 2.1. This indication is shown several seconds before the tester switches off.

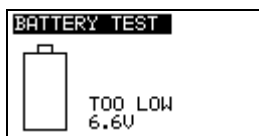

Figure 2.1: Indication of discharged batteries

The rechargeable NiMh storage batteries will be charged automatically as soon as the charger is connected with the charging jack of the installation tester. The polarity of the charging jack will be displayed as shown in figure 2.2. An integrated protective circuit controls the charging process and ensures an optimum battery lifetime.



Figure 2.2: Polarity of the charging jack

Symbol:



Indication of the storage battery charging process

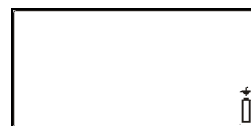

Figure 2.3: Charging in progress



General warnings:

- ❑ If the installation tester is connected to an installation, a dangerous voltage might be applied to the battery compartment! Disconnect all test cables / accessories from the installation tester and switch the installation tester off before replacing the batteries / storage batteries and before opening the cover of the battery / fuse compartment!
- ❑ Please make sure that the batteries / storage batteries are inserted correctly, because otherwise the installation tester cannot be operated and the storage batteries will discharge.
- ❑ Do not recharge alkaline batteries!
- ❑ Use only the charger included in the delivery!

Notes:

- ❑ Before the first use! Insert the storage batteries into the battery compartment and charge the storage batteries for at least 16 hours.
- ❑ The charger inside the installation tester is a cell pack charger. This means that the storage batteries are connected in series during charging. For this reason, the storage batteries must be equivalent (same state of charge, same condition, same type and same age).
- ❑ If the installation tester is not used for a longer period of time, remove all storage batteries from the battery compartment.
- ❑ Use alkaline batteries or rechargeable NiMh batteries of size AA only! It is recommended to use storage batteries with a minimum capacity of 2100 mAh.

- ❑ Unpredictable chemical processes might occur during the charging of storage batteries that have not been used for a longer period of time (more than 6 months). In this case, it is recommended to repeat the charging / discharging cycle at least 2 to 4 times.
- ❑ If no improvement is achieved after several charging / discharging cycles, every storage battery should be tested individually (by comparing the storage battery voltages, testing by means of a cell charger etc.). It is very likely that only some of the storage batteries have lost capacity. If one storage battery differs from the other ones, this might affect the correct functioning of the entire storage battery block!
- ❑ The effects described above must not be confused with the normal battery capacity decrease over time. All rechargeable batteries (storage batteries) lose some of their battery capacity when being charged / discharged several times. This information is provided in the technical data specified by the battery manufacturer.

2.3 Standards applied

The BENNING IT 130 installation tester is manufactured and tested in compliance with the following regulations:

Electromagnetic compatibility (EMC)

EN 61326-1 Electrical equipment for measurement, control and laboratory use
– EMC requirements
Class B (hand-held equipment in controlled EM environments)

Safety (LVD)

EN 61010-1 Safety requirements for electrical equipment for measurement, control and laboratory use – Part 1: General requirements

EN 61010-2-030 Safety requirements for electrical equipment for measurement, control and laboratory use – Part 2-030: Particular requirements for testing and measuring circuits

EN 61010-031 Safety requirements for electrical equipment for measurement, control and laboratory use – Part 031: Safety requirements for hand-held probe assemblies for electrical measurement and test

EN 61010-2-032 Safety requirements for electrical equipment for measurement, control and laboratory use – Part 2-032: Particular requirements for hand-held and hand-manipulated current sensors for electrical test and measurement

Functionality

EN 61557 Electrical safety in low-voltage distribution systems up to 1000 V_{AC} and 1500 V_{DC} – Equipment for testing, measuring or monitoring of protective measures
Part 1: General requirements
Part 2: Insulation resistance
Part 3: Loop impedance
Part 4: Resistance of earth connection and equipotential bonding
Part 5: Resistance to earth
Part 6: Effectiveness of residual current devices (RCD) in TT, TN and IT systems
Part 7: Phase sequence
Part 10: Combined measuring equipment for testing, measuring or monitoring of protective measures

DIN 5032 Photometry
Part 7: Classification of illuminance meters and luminance meters

Reference standards for electrical installations and components

EN 61008 Residual current operated circuit-breakers without integral overcurrent protection for household and similar uses (RCCBs)

EN 61009 Residual current operated circuit-breakers with integral overcurrent protection for household and similar uses (RCBOs)

EN 60364-4-41 Low-voltage electrical installations – Part 4-41: Protection for safety – Protection against electric shock

BS 7671 IEE Wiring Regulations (17th edition)

AS / NZS 3017 Electrical installations – Verification guidelines

Note on EN and IEC standards:

- This operating manual contains references to European standards. All standards of the series EN 6XXXX (e.g. EN 61010) correspond to the respective IEC standards with the same number (e.g. IEC 61010). They only differ in the modified parts due to the European harmonization procedures.

3 Device description

3.1 Front panel

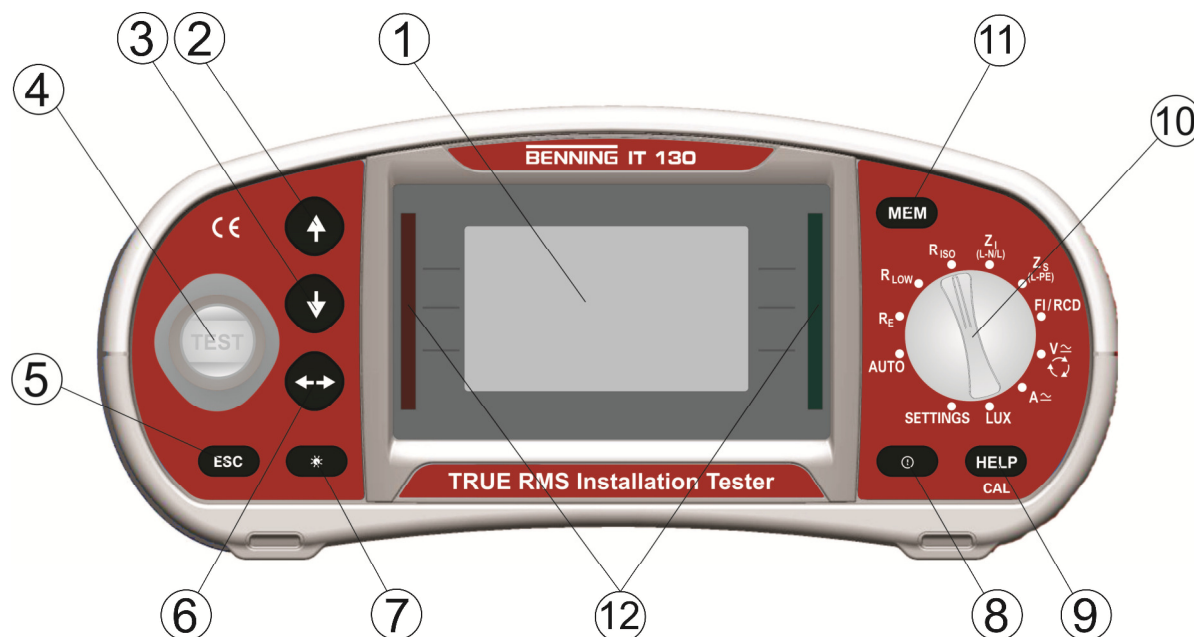

Figure 3.1: Front panel

Caption:

1	LCD	Matrix display with 128 x 64 pixels and background lighting
2	UP	Modifies selected parameters
3	DOWN	
4	TEST	Start of measurement PE contact electrode for protective conductor connection
5	ESC	Back / cancel
6	TAB	Selects parameters in the measuring function selected
7	Backlight, Contrast	Modifies background lighting and contrast
8	ON / OFF	Switches the tester on or off; automatic switch-off ("APO") after 15 minutes without pressing a key
9	HELP / CAL	Help function with connection diagrams (press approx. 2 seconds for R LOW and ΔU) For calibrating the test cables in the R LOW and CONTINUITY function Starts the Z_{REF} measurement in the sub-function ΔU voltage drop
10	Function selector switch	Rotary switch for selecting the measuring functions, "AUTO" switch position and "SETTINGS" mode
11	MEM	Storage / recall of measuring results; stores the settings of the current clamp adapter
12	Green / red LED	PASS / FAIL indication of the measuring results

3.2 Connection panel

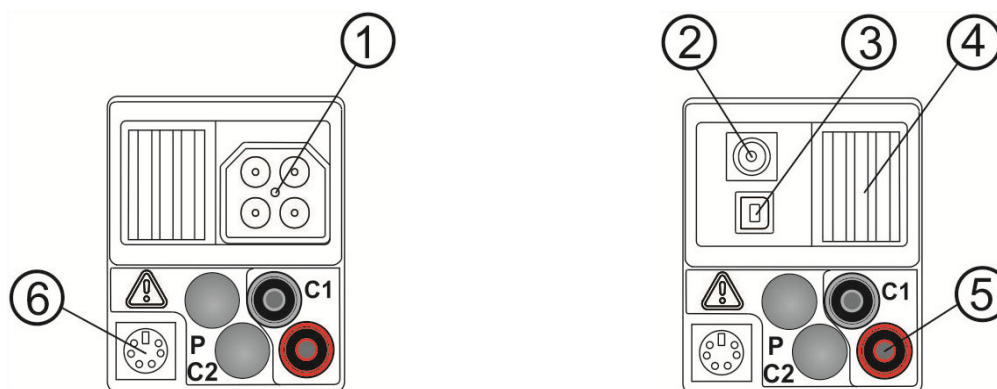

Figure 3.2: Connection panel

Caption:

1	Test connection	Measuring inputs / outputs
2	Charging jack	For charging rechargeable NiMh storage batteries
3	USB port	USB interface (1.1) for PC connection
4	Protective cover	
5	C1	Measuring input for optional current clamp adapter BENNING CC 1 / BENNING CC 2 / BENNING CC 3
6	PS/2 port	Serial RS232 interface for PC connection; connection for optional BENNING luxmeter type B (044111) and barcode scanner (009371)



Warnings!

- ❑ The maximum admissible voltage between the testing terminals and earth is 550 V!
- ❑ The maximum admissible voltage between the testing terminals is 550 V!
- ❑ The maximum admissible voltage at the measuring input C1 is 3 V!
- ❑ The maximum admissible short-term voltage of the external charger is 14 V!

3.3 Rear panel

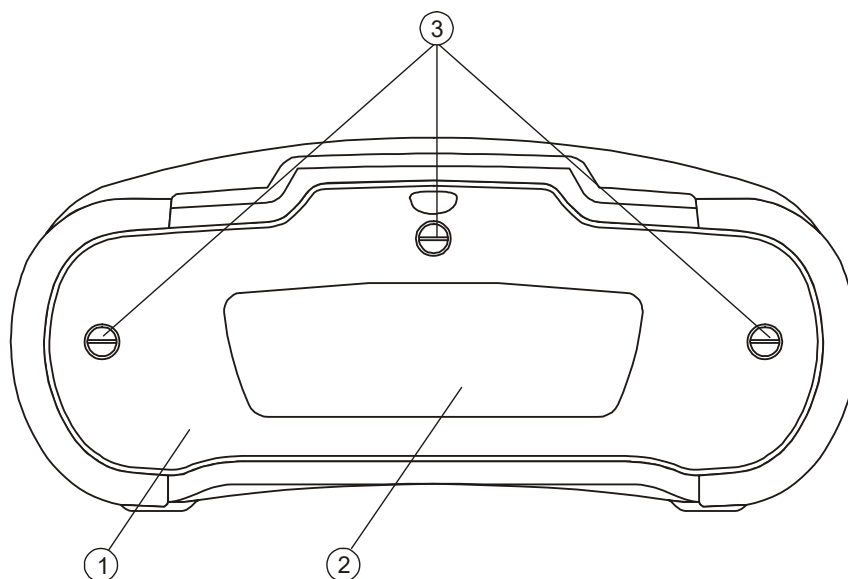

Figure 3.3: Rear panel

Caption:

1	Cover of the battery / fuse compartment
2	Information label
3	Screws for the battery / fuse compartment cover

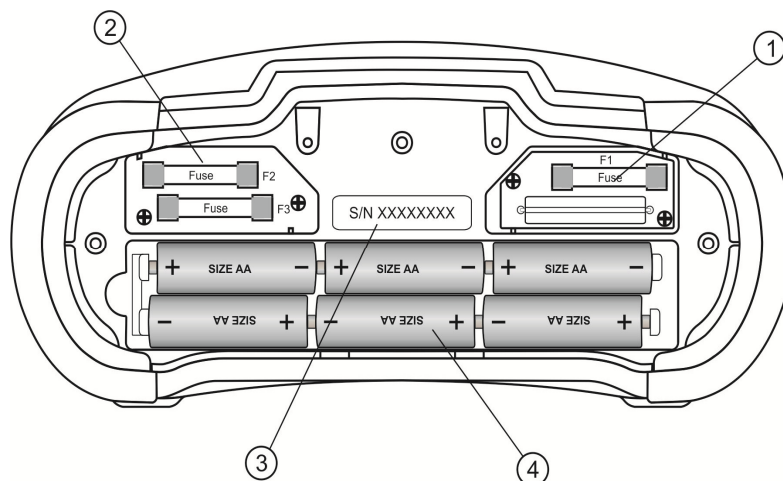

Figure 3.4: Battery / fuse compartment

Caption:

1	Fuse F1	M 315 mA / 250 V
2	Fuses F2 and F3	If one of the fuses F2 or F3 has blown, the device must not be used anymore. In this case, the device must be sent to BENNING for inspection and repair.
3	Serial number label	
4	Storage batteries / batteries	Size AA, alkaline / rechargeable NiMh, quantity: 6 pieces

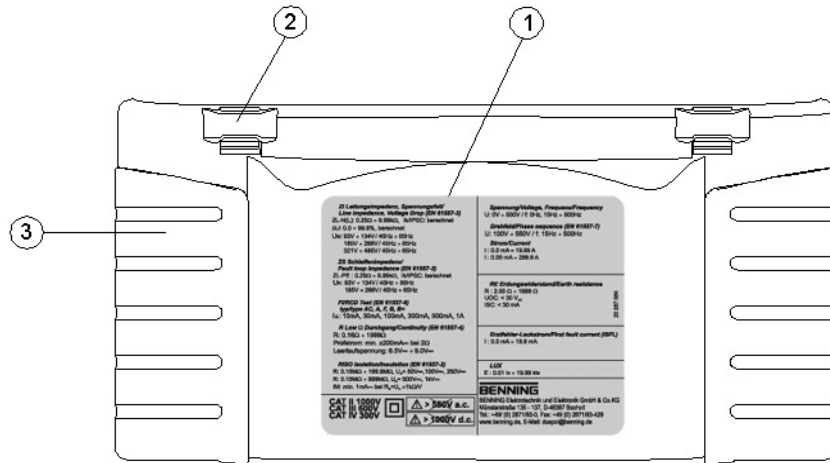

Figure 3.5: Bottom view

Caption:

1	Information label
2	Carrying strap openings
3	Lateral covers

3.4 Carrying the installation tester

The installation tester can be carried in different ways by means of the accessories included in the standard scope of delivery.



The tester can be hung around the operator's neck by means of the carrying strap.



It is also possible to carry the tester in the padded carrying case and to use it in a horizontal position. The carrying case is provided with an aperture for passing through the test cable.

3.4.1 Attachment of the carrying strap

Please choose one of the two methods shown:

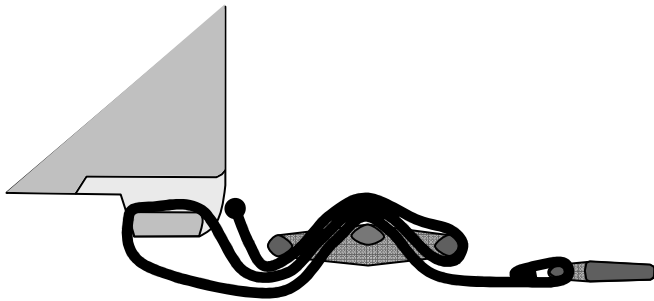

Figure 3.6: First method

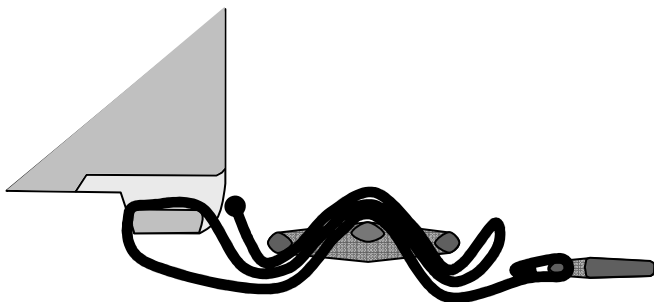

Figure 3.7: Alternative method

Please check the carrying strap for safe fastening regularly.

3.5 Scope of delivery and optional accessories

3.5.1 Standard scope of delivery

- 1 x BENNING IT 130 installation tester
- 1 x padded carrying case (item no. 10008291)
- 1 x "Commander" test probe (switchable by means of "TEST" key) (item no. 044155)
- 1 x test cable with shock-proof plug (item no. 10008295)
- 1 x universal three-wire test cable (black, blue, green) (item no. 10008296)
- 1 x set of test probes (black, blue, green) (item no. 10008304 - 10008306)
- 1 x set of alligator clips (black, blue, green) (item no. 10008301 - 10008303)
- 1 x carrying strap (item no. 10008290)
- 1 x RS 232-PS/2 interface cable (item no. 10008313)
- 1 x USB interface cable (item no. 10008312)
- 6 x rechargeable NiMh storage batteries of size AA
- 2 x batteries of size AAA
- 1 x charger (item no. 10008308)
- 1 x CD-ROM with BENNING PC-WIN IT 130 logging software, operating manual and quick reference guide in PDF format
- 1 x quick reference guide
- 1 x calibration certificate

3.5.2 Optional accessories





<p>Earthing kit Earthing kit, 2 earth rods, 3 test cables, 2 x L = 20 m, 1 x L = 4.5 m Item no.: 044113</p>	
<p>Current clamp adapters BENNING CC 1, 1 A to 400 A AC Output: 1 mV per 1 A Item no.: 044037 BENNING CC 3, 0.2 A to 300 A AC / DC Output: 1 mV / 10 mV per 1 A Item no.: 044038</p>	
<p>Luminous intensity sensor BENNING Luxmeter type B For the planning and installation of interior and exterior lighting. Item no.: 044111</p>	
<p>"Commander" test plug For shock-proof socket, switchable with "TEST" and "MEM" keys, with "PASS" / "FAIL" indication by means of green/red LED, PE contact electrode for detecting the phase voltage at the protective conductor connection (PE). Item no.: 044149</p>	
<p>CEE measuring adapter 16 A, 5-pin, for measuring the voltage and phase sequence (rotary field) at 16 A CEE sockets. Item no.: 044148</p>	
<p>Measuring line (40 m) 40 m measuring line with rewriter and wrist strap, for measuring protective conductor connections. Item no.: 044039</p>	
<p>Barcode scanner Barcode scanner with PS/2 interface for identifying the measuring point and renaming the storage location. Item no.: 009371</p>	

4 Operating the BENNING IT 130 installation tester

4.1 Indications and acoustic warning signals

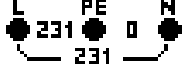

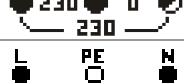
4.1.1 Connection monitor

The connection monitor shows the voltages applied to the testing terminals as well as information on active testing terminals in the AC mains.

	The voltage applied is displayed together with the testing terminal indication. All three testing terminals L, N and PE are used for the selected measurement.
	The voltage applied is displayed together with the testing terminal indication. The testing terminals L and N are used for the selected measurement.
	The testing terminals L and PE are active testing terminals. The testing terminal N should be connected as well to show a correct input voltage.
	The polarity of the testing voltage applied (R LOW, R ISO) is displayed at the output terminals L and N.







4.1.2 Battery indication













The battery indication shows the current state of charge of the storage battery as well as whether an external charger is connected.

	Battery capacity indication
	Low state of charge. The storage battery's state of charge is too low to ensure correct measuring results. Replace the batteries or recharge the storage batteries.
	Charging in progress (with the charger being connected)



4.1.3 Warnings and messages

The following warnings and messages are displayed:

	Warning! High voltage is applied to the testing terminals.
	Warning! Dangerous voltage at the PE connection! Immediately stop the measuring process and eliminate the fault / the connection problem before continuing with the measurement!
DC VOLTAGE!	Warning! Too high DC voltage (> 50 V DC) applied to the testing terminals!
	The conditions at the input terminals allow starting the measurement. Please observe further warnings and messages!
	The conditions at the input terminals do not allow starting the measurement. Please observe further warnings and messages!
	Measurement is in progress. Please observe warnings that might be displayed!
	The tester is overheated. Measurements are interrupted until the internal temperature has dropped below the admissible limiting value.

	Results can be saved.
	A high interference voltage has been detected during measurement. This might result in incorrect measuring results.
	L and N have been interchanged.
	RCD has been tripped during measurement (in RCD functions).
	Portable RCD (PRCD) has been selected (only for documentation purposes).
	RCD of type EV (Electric Vehicle)
	RCD of type MI (Mobile Installation)
	The test cable resistance for low-impedance measurement / continuity test has been compensated.
	High earthing resistance of the measuring probes. This might result in incorrect measuring results.
	The current is too low for the accuracy specified. This might result in incorrect measuring results. Please check in the current clamp adapter settings whether the sensitivity of the current clamp adapter can be increased.
	The measuring signal is outside the measuring range This might result in incorrect measuring results.
	Single fault in the IT network.
	Fuse F1, F2 or F3 is defective. If one of the fuses F2 or F3 has blown, the device must not be used anymore. In this case, the device must be sent to BENNING for inspection and repair.

4.1.4 Evaluation field

	The measuring result is within the preset limiting values (green LED).
	The measuring result is outside the preset limiting values (red LED).
	Measurement has been aborted. Please observe the warnings and messages displayed.

4.1.5 Acoustic warning signals

Continuous sound	Warning! Dangerous voltage at the PE connection!
------------------	---

4.1.6 Help menu ("HELP" key)

HELP	Opens the help menu.
-------------	----------------------

Help menus are available for all measuring functions. The help menu contains graphic connection diagrams showing how to connect the installation tester to the electrical installation. After having selected the desired measuring function, press the "HELP" key to view the corresponding help menu.

Keys used in the help menu

UP / DOWN	Selects the next / previous connection diagram
ESC / HELP / function selector switch	Use these keys to exit the help menu.

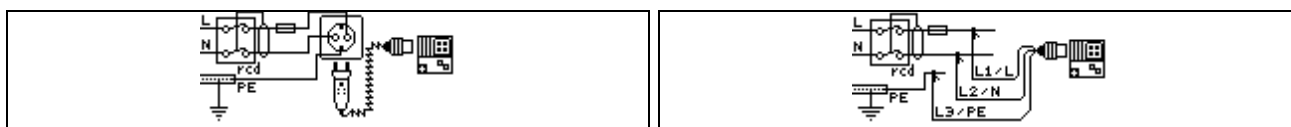

Figure 4.1: Connection diagrams of the help menu

4.1.7 Background lighting and contrast

Use the key for background lighting and contrast to make the following settings:

Briefly press the key	Activates the background lighting for approx. 10 seconds
Press and hold the key for 1 second	Switches the background lighting on permanently until the tester switches off or the key is pressed again
Press and hold the key for 2 seconds	Allows to set the LCD contrast

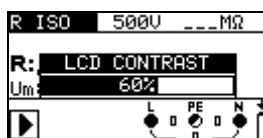

Figure 4.2: LCD contrast setting

Keys used for contrast setting

UP	Increases the contrast
DOWN	Reduces the contrast
TEST	Applies the adjusted contrast
ESC	Exits the settings without any changes

4.2 Function selector switch

The function selector switch is intended for selecting the

- test and measuring functions
- "AUTO" mode
- "SETTINGS" mode

Key functions after having selected the **test / measuring function**:

UP / DOWN	Selects the sub-function of the adjusted test / measuring function (only for rotary switch positions R_{LOW} , Z_I , Z_S , FI/RCD)
TAB	Selects the parameters and limiting values
TEST	Start of measurement
MEM	Storage / recall of the measuring results
ESC	Back / cancel

Key functions in the **Parameters** field:

UP / DOWN	Modifies the selected parameter
TAB	Selects the next parameter
MEM	Storage / recall of the measuring results

Parameters and limiting values for evaluating the measuring results:

Parameter, limiting value	WITHOUT	No parameters / limiting values, indication: <u> </u> .
	ON	Measuring results – will be marked as "PASS" / "FAIL" according to the parameters and limiting values set

Please find further information on how to use the test / measuring functions of the installation tester in chapter **5. Measurements**.

4.3 "AUTO" mode

Turn the function selector switch to the **"AUTO"** mode to select the test / measuring functions carried out by means of the "Commander" test probe or the optional "Commander" test plug for shock-proof sockets (044149).

Select the test / measuring function by means of the  keys of the "Commander". Please find a detailed description of the "Commander" test probe and the optional "Commander" test plug for shock-proof sockets (044149) in Appendix C.

4.4 "SETTINGS" mode

Turn the measuring function selector switch to the "SETTINGS" mode in order to make the following settings at the tester:

- ❑ **MEMORY** (recall data, delete data, delete entire memory)
- ❑ **SELECT LANGUAGE** (GB, D, E, F, NL)
- ❑ **SET DATE / TIME**
- ❑ **EARTHING SYSTEM** (TN/TT or IT network)
- ❑ **RCD TESTING** (according to EN 61008 / EN 61009, IEC 60364-4-41, BS 7671, AS/NZS 3017)
- ❑ **SET Isc FACTOR** (0.20 - 3.00)
- ❑ **COMMANDER ON/OFF**
- ❑ **INITIAL SETTINGS** (reset to factory settings)
- ❑ **CLAMP settings** (selection of the optional current clamp adapters BENNING CC 1 (044037), BENNING CC 3 (044038))

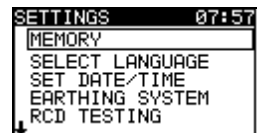

Figure 4.3: "SETTINGS" mode

Keys used:

UP / DOWN	Selects the respective option
TEST	Confirms the selected option
ESC / function selector switch	Back / cancel without any changes

4.4.1 Memory

In this menu, it is possible to recall stored data and to delete the data of a measuring point or even the entire memory.

Please refer to chapter 6 Management of measured values for further information.

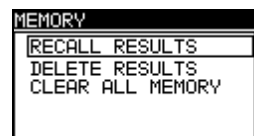

Figure 4.4: Memory options

Keys used:

UP / DOWN	Selects the respective option
TEST	Confirms the selected option
ESC	Back / cancel to the Settings menu
Function selector switch	Back / cancel to the selected measuring function

4.4.2 Language

In this menu, it is possible to select the respective language.



Figure 4.5: Selecting the language

Keys used:

UP / DOWN	Selects the language
TEST	Confirms the selected language and returns to the Settings menu
ESC	Back / cancel to the Settings menu
Function selector switch	Back / cancel to the selected measuring function

4.4.3 Date and time

In this menu, it is possible to set the date and time.

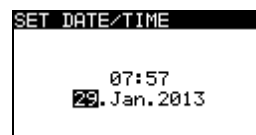

*Figure 4.6:
Setting date and time*

Keys used:

TAB	Selects the date / time field
UP / DOWN	Modifies the selected field
TEST	Confirms the change and returns to the Settings menu
ESC	Back / cancel to the Settings menu
Function selector switch	Back / cancel to the selected measuring function

Note:

- If the batteries are removed for more than 1 minute, the date and time settings will be lost.

4.4.4 Earthing system (power supply network)

In this menu, it is possible to set the available earthing system (power supply network).

The following options are available:

- TN / TT network
- IT network

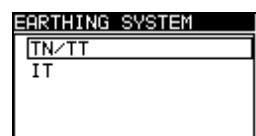

*Figure 4.7:
Selecting the earthing system*

Keys used:

UP / DOWN	Selects the earthing system
TEST	Confirms the selected earthing system and returns to the Settings menu
ESC	Back / cancel to the Settings menu
Function selector switch	Back / cancel to the selected measuring function

4.4.5 RCD testing

In this menu, it is possible to set the standard used for RCD testing.

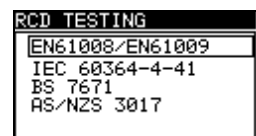

Figure 4.8:
Selecting the RCD standard

Keys used:

UP / DOWN	Selects the standard
TEST	Confirms the selected standard and returns to the Settings menu
ESC	Back / cancel to the Settings menu
Function selector switch	Back / cancel to the selected measuring function

The maximum RCD tripping times vary from standard to standard.

The times specified in the individual standards are listed in the following.

By default, the tripping times in compliance with the EN 60364-4-41 standard are preset. The EN 60364-4-41 standard defines different tripping times for TN/IT networks and TT networks as can be seen in table 41.1.

Tripping times in compliance with **EN 60364-4-41:**

	U _o	1/2 × I _{ΔN} [*]	I _{ΔN}	2 × I _{ΔN}	5 × I _{ΔN}
TN/IT	≤120 V	t _Δ > 800 ms	t _Δ ≤ 800 ms	t _Δ < 150 ms	t _Δ < 40 ms
	≤230 V	t _Δ > 400 ms	t _Δ ≤ 400 ms		
TT	≤120 V	t _Δ > 300 ms	t _Δ ≤ 300 ms		
	≤230 V	t _Δ > 200 ms	t _Δ ≤ 200 ms		

U_o: Nominal voltage of external conductor to earth

Example of a tripping time evaluation for I_{ΔN}, U_o: ≤230 V

Setting	Tripping time t _Δ	Evaluation field
IEC 60364-4-41 TN/IT	< 400 ms	✓
	400 ms < t _Δ < 999 ms	✗
	> 999 ms	✗
IEC 60364-4-41 TT	< 200 ms	✓
	200 ms < t _Δ < 999 ms	✗
	> 999 ms	✗

Tripping times in compliance with **EN 61008/EN 61009:**

	1/2 × I _{ΔN} [*]	I _{ΔN}	2 × I _{ΔN}	5 × I _{ΔN}
Standard RCDs (undelayed)	t _Δ > 300 ms	t _Δ < 300 ms	t _Δ < 150 ms	t _Δ < 40 ms
Selective RCDs (delayed)	t _Δ > 500 ms	130 ms < t _Δ < 500 ms	60 ms < t _Δ < 200 ms	50 ms < t _Δ < 150 ms

Tripping times in compliance with **BS 7671:**

	1/2 × I _{ΔN} [*]	I _{ΔN}	2 × I _{ΔN}	5 × I _{ΔN}
Standard RCDs (undelayed)	t _Δ > 1999 ms	t _Δ < 300 ms	t _Δ < 150 ms	t _Δ < 40 ms
Selective RCDs (delayed)	t _Δ > 1999 ms	130 ms < t _Δ < 500 ms	60 ms < t _Δ < 200 ms	50 ms < t _Δ < 150 ms

Tripping times in compliance with **AS/NZS 3017**)**:

RCD type	$I_{\Delta N}$ [mA]	$\frac{1}{2} \times I_{\Delta N}^*)$ t_{Δ}	$I_{\Delta N}$ t_{Δ}	$2 \times I_{\Delta N}$ t_{Δ}	$5 \times I_{\Delta N}$ t_{Δ}	Remark
I	≤ 10	> 999 ms	40 ms	40 ms	40 ms	maximum tripping time
II	$> 10 \leq 30$		300 ms	150 ms	40 ms	
III	> 30		300 ms	150 ms	40 ms	
IV S	> 30	> 999 ms	500 ms	200 ms	150 ms	minimum non-tripping time
			130 ms	60 ms	50 ms	

*) Minimum testing time for a current of $\frac{1}{2} \times I_{\Delta N}$, RCD must not trip

***) Testing current and measuring accuracy correspond to the requirements specified by AS/NZS 3017

Maximum testing times and selected testing current for standard (undelayed) RCDs:

Standard	$\frac{1}{2} \times I_{\Delta N}$	$I_{\Delta N}$	$2 \times I_{\Delta N}$	$5 \times I_{\Delta N}$
EN 60364-4-41	1000 ms	1000 ms	150 ms	40 ms
EN 61008 / EN 61009	300 ms	300 ms	150 ms	40 ms
BS 7671	2000 ms	300 ms	150 ms	40 ms
AS/NZS 3017 (I, II, III)	1000 ms	1000 ms	150 ms	40 ms

Maximum testing times and selected testing current for selective (delayed) RCDs:

Standard	$\frac{1}{2} \times I_{\Delta N}$	$I_{\Delta N}$	$2 \times I_{\Delta N}$	$5 \times I_{\Delta N}$
EN 60364-4-41	1000 ms	1000 ms	200 ms	150 ms
EN 61008 / EN 61009	500 ms	500 ms	200 ms	150 ms
BS 7671	2000 ms	500 ms	200 ms	150 ms
AS / NZS 3017 (IV)	1000 ms	1000 ms	200 ms	150 ms

4.4.6 Isc factor (scaling factor)

In this menu, it is possible to set the Isc factor (scaling factor) for calculating the short-circuit current (I_k) in the functions ZI (L-N/L) and Zs (L-PE).

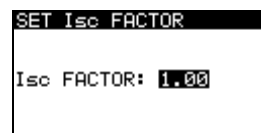

Figure 4.9:
Selecting the Isc factor

Keys used:

UP / DOWN	Modifies the Isc factor
TEST	Confirms the adjusted Isc factor
ESC	Back / cancel to the Settings menu
Function selector switch	Back / cancel to the selected measuring function

The short-circuit current I_k in the power supply system is of particular importance for the selection and testing of protective circuits (fuses, overcurrent protection devices, RCDs). The default value of the Isc factor (I_k) is 1.00. The value has to be set according to local requirements.

The Isc factor can be set within the range of $0.20 \div 3.00$.

4.4.7 Commander ON/OFF

In this menu, it is possible to enable or disable the "Commander" (switchable test probe).

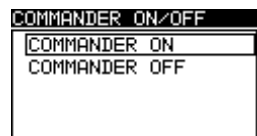

Figure 4.10: Selecting the "Commander" support

Keys used:

UP / DOWN	Selects Commander ON (enabled) / Commander OFF (disabled)
TEST	Confirms the selected option
ESC	Back / cancel to the Settings menu
Function selector switch	Back / cancel to the selected measuring function

Note:

- ❑ The "Commander OFF" (disabled) option is intended for deactivating the operating keys of the "Commander" (except for the background lighting key). It is useful to disable the "Commander", if strong sources of interference might affect the correct functioning of the "Commander".

4.4.8 Initial settings

In this menu, it is possible to reset the settings, measuring parameters and limiting values of the installation tester to their initial (factory) settings.

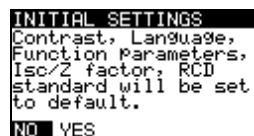

Figure 4.11: Initial settings dialog

Keys used:

UP / DOWN	Selects the option [YES, NO]
TEST	Confirms the selected option
ESC	Back / cancel to the Settings menu
Function selector switch	Back / cancel to the selected measuring function

Note:

- ❑ If the tester is reset to its initial (factory) settings, all settings made will be lost!
- ❑ If the batteries are removed for more than 1 minute, all settings made will be lost.

The initial (factory) settings are defined as follows:

Settings of the tester	Default setting
Language	German
Contrast	50 %
Earthing system	TN / TT
Isc factor	1.00
RCD standards	EN 60364-4-41
"Commander" test probe	ON
Current clamp settings	BENNING CC 3

Measuring function Sub-function	Parameter / limiting value
RE	No limiting value
R ISO	without limiting value, nominal testing voltage: 500 V
R LOW CONTINUITY	No limiting value No limiting value
ZI (L-N/L) line impedance ΔU voltage drop	Fuse type: none selected ΔU : 4.0 %, Z_{REF} : 0.00 Ω
Zs (L-PE) loop impedance Zsrcd	Fuse type: none selected Fuse type: none selected
RCD	RCD t Nominal differential current: $I_{\Delta N}$ =30 mA RCD type: AC, undelayed Testing current with initial polarity:  (0°) Limiting value for contact voltage: 50 V Nominal differential current multiplier: $\times 1$

Note:

- It is also possible to reset the tester to its initial (factory) settings by pressing the "TAB" key when simultaneously switching the tester on.

4.4.9 Clamp settings

In the **CLAMP settings** menu, it is possible to configure the C1 measuring input to the current clamp adapter used.

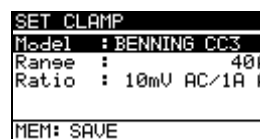

Figure 4.12:

Configuring the current clamp measuring input

Setting parameters:

Type	BENNING CC 1
Measuring range	400 A AC
Type	BENNING CC 3
Measuring range	40 A / 300 A AC / DC

Selecting the parameters

Keys used:

UP / DOWN	Selects the respective options
TEST	Confirms the selected option
MEM	Saves the settings
ESC	Back / cancel to the Settings menu
Function selector switch	Back / cancel to the selected measuring function

Modifying the selected parameters**Keys used:**

UP / DOWN	Modifies the selected parameter
TEST	Confirms the selected parameter
MEM	Saves the settings
ESC	Back / cancel to the Settings menu
Function selector switch	Back / cancel to the selected measuring function

Note:

- Please pay attention to the measuring range of the installation tester. The measuring range of the current clamp might be higher than that of the installation tester.

5 Measurements

5.1 TRMS voltage, frequency and phase sequence

The voltages applied to the testing terminals are permanently displayed by means of the connection monitor. In the **VOLTAGE TRMS** measuring range (true RMS voltage value), the measured values for voltage (AC/DC) and frequency as well as the phase sequence (rotary field) detected can be saved. The measurements are carried out in compliance with the EN 61557-7 standard.

Key function as described in chapter

4.2 Function selector switch

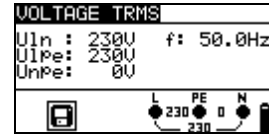

Figure 5.1:
Voltage in a single-phase system

Testing parameters

It is not necessary to set any parameters.

Connection plan

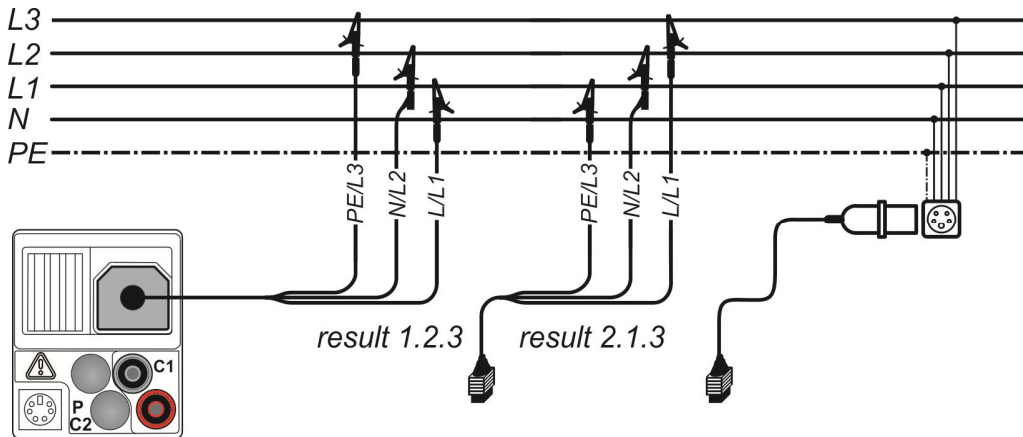

Figure 5.2: Connection of the three-wire test cable and the optional CEE measuring adapter (044148) in a three-phase system

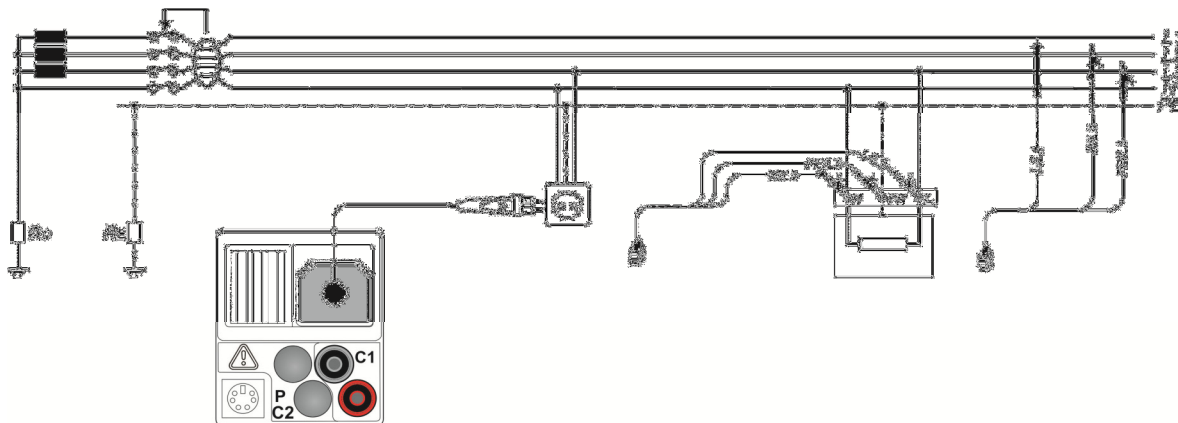

Figure 5.3: Connection of the optional "Commander" test plug (044149) and the three-wire test cable in a single-phase / three-phase system

How to perform voltage measurements

- ❑ Select the **V_~** function by means of the function selector switch. The display shows **VOLTAGE TRMS**.
- ❑ Connect the test cables to the test object (see figure 5.2 and figure 5.3).
- ❑ Save the measuring result by pressing the "**MEM**" key.

The measurement is performed immediately after the **VOLTAGE TRMS** function has been selected.



Figure 5.4: Examples for voltage measurements in single-phase and three-phase systems

Results displayed for single-phase systems:

- Uln** voltage between phases and neutral conductor
- U1pe** voltage between phase and protective conductor
- Unpe** voltage between neutral and protective conductors
- f** frequency

Results displayed for three-phase systems:

- U12** voltage between testing terminals L1 and L2
- U13** voltage between testing terminals L1 and L3
- U23** voltage between testing terminals L2 and L3
- 1.2.3** correct connection – clockwise phase sequence
- 3.2.1** wrong connection – counter-clockwise phase sequence
- f** frequency

Results displayed for IT systems:

- U12** voltage between testing terminals L1 and L2
- U1pe** voltage between testing terminals L1 and PE
- U2pe** voltage between testing terminals L2 and PE
- f** frequency

5.2 Insulating resistance

The measurement of the insulating resistance is performed in order to prove the proper condition of the insulation and in order to exclude electrical danger.

Typical applications are the following cases:

- ❑ Insulating resistance between the active conductors (L/N) of an installation and the protective conductor / earth (PE) => protection against electric shock,
- ❑ Insulating resistance between the active conductors (L/N) of an installation => protection against short-circuit (over-current) and guarantee of the functional safety,
- ❑ Insulating resistance of non-conductive rooms (walls and floors),
- ❑ Insulating resistance of earthing cables and
- ❑ Resistance of semiconductive (antistatic) floors.

Key function as described in chapter
4.2 Function selector switch

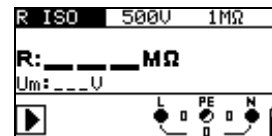

Figure 5.5:
 Insulating resistance

Testing parameters

Uiso	Nominal testing voltage [50 V, 100 V, 250 V, 500 V, 1000 V]
Limiting value	Minimum insulating resistance [without limits (---), 0.01 MΩ ÷ 200 MΩ]

Connection plan

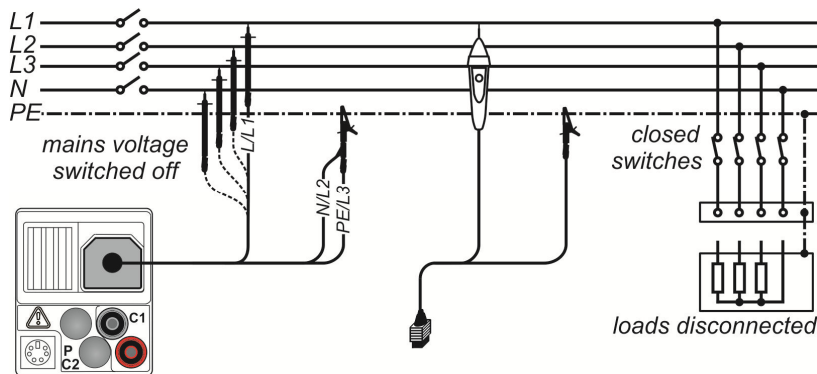

Figure 5.6: Connection of the three-wire test cable and the "Commander" test probe

How to perform insulating resistance measurements

- ❑ Select the **R_{ISO}** function by means of the function selector switch.
- ❑ Set the required testing voltage and the limiting value (optional).
- ❑ Make sure that the test object is free of voltage and discharge available capacities.
- ❑ Connect the test cables to the test object (see figure 5.6).
- ❑ Press the "**TEST**" key to start the measurement. Double-click the "**TEST**" key (MΩ flashes) to perform a continuous measurement. Press the key again to finish the measurement.
- ❑ After measurement, wait until the test object is completely discharged.
- ❑ Save the measuring result by pressing the "**MEM**" key (optional).



Figure 5.7: Example of an insulating resistance measurement

Results displayed:

R insulating resistance
Um testing voltage (actual value)

Attention:

- ❑ Measurements of the insulating resistance must be carried out only at test objects which are free of voltage!
- ❑ Disconnect all loads and close all switches for measuring the insulating resistance between conductors of the installation.
- ❑ Do not touch the test object during measurement and before it is completely discharged! There is danger of a life-threatening electric shock!
- ❑ If the insulating resistance measurement is carried out on a capacitive object, automatic discharging might take place time-delayed. The warning symbol and the actual voltage will be displayed during discharging.
- ❑ Do not connect the test cables to external voltages higher than 550 V (AC or DC) in order not to damage the BENNING IT 130 installation tester!

5.3 Low-impedance resistance / continuity test

The measurement of the low-impedance resistance / continuity test is intended for testing the protective conductor, earthing conductor and equipotential bonding conductor connections of an electrical installation.

Two sub-functions are available:

- **R LOWΩ** – resistance measurement in compliance with EN 61557-4 with a testing current of 200 mA and polarity reversal
- **CONTINUITY** – continuous continuity test with a reduced testing current of 7 mA.

Key function as described in chapter 4.2 Function selector switch

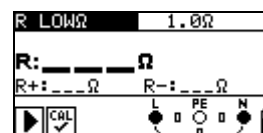

Figure 5.8: Low-impedance resistance RLOW Ω with a testing current of 200 mA

Testing parameters

Test	Sub-function [R LOWΩ, CONTINUITY]
Limiting value	Maximum resistance [without limits (---), 0.1 Ω ÷ 20.0 Ω]

Additional testing parameter for continuity test sub-function:

	Buzzer ON (sounds if the resistance is lower than the limiting value set) or OFF
--	---

5.3.1 Low-impedance resistance with a testing current of 200 mA

The resistance measurement is performed with automatic polarity reversal of the testing voltage.

Connection plan

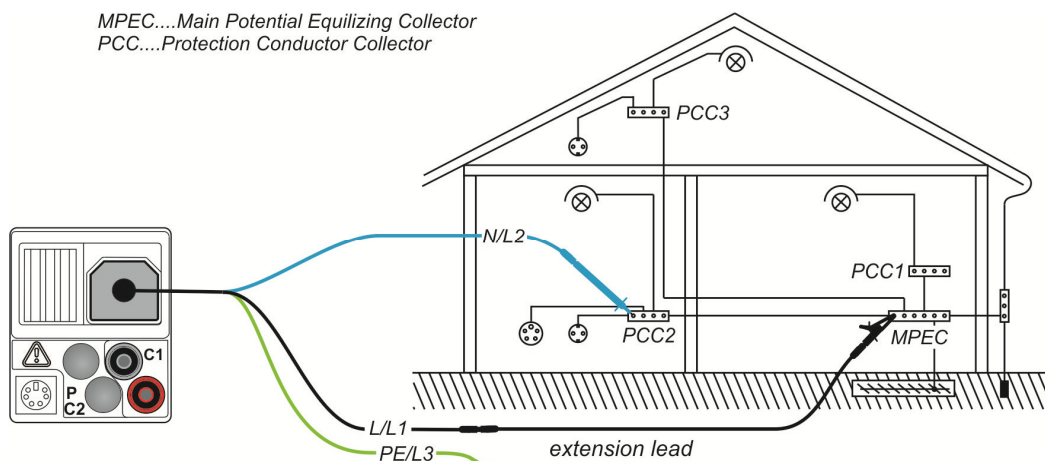

Figure 5.9: Connection of the three-wire test cable and the optional 40 m measuring line BENNING TA 5 (044039)

How to perform low-impedance measurements R LOWΩ

- ❑ Select the **R_{LOW}** function by means of the function selector switch.
- ❑ Set the sub-function to **R LOWΩ**.
- ❑ Set the limiting value (optional).
- ❑ Connect the test cables to the installation tester and compensate the test cable resistance, if necessary (see section 5.3.3 Compensation (null balance) of the test cable resistance).
- ❑ Make sure that the test object is free of voltage and discharge available capacities.
- ❑ Connect the test cables to the test object (see figure 5.9).
- ❑ Press the "TEST" key to start the measurement.
- ❑ Save the measuring result by pressing the "MEM" key (optional).



Figure 5.10: Example of a low-impedance measurement RLOWΩ

Results displayed:

- R R LOWΩ – low-impedance resistance
- R+ partial result at positive polarity
- R- partial result at negative testing polarity

5.3.2 Continuity test with a testing current of 7 mA

This test function can be compared to the continuity test function of a digital multimeter or of a continuity tester with low testing current. The continuous test is done without polarity reversal and can be used for testing inductive components.

Connection plan

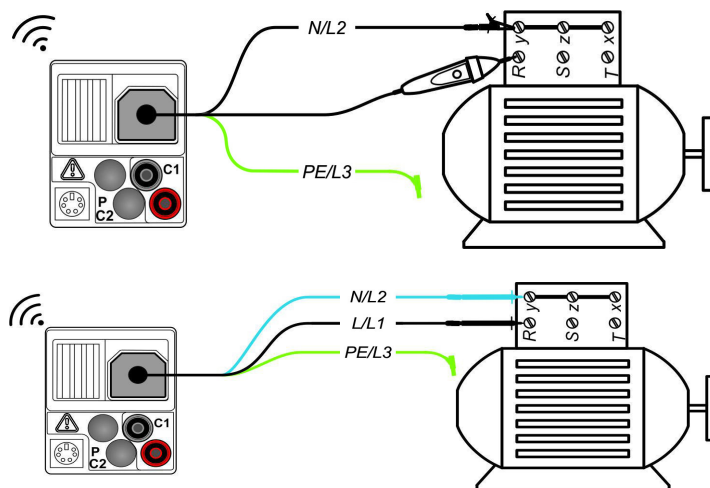

Figure 5.11: Using the "Commander" test probe and the three-wire test cable

How to perform continuity tests

- ❑ Select the **R_{LOW}** function by means of the function selector switch.
- ❑ Set the sub-function to **CONTINUITY**.
- ❑ Set the limiting value (optional).
- ❑ Connect the test cables to the installation tester and compensate the test cable resistance, if necessary (see section 5.3.3 Compensation (null balance) of the test cable resistance).
- ❑ Make sure that the test object is free of voltage and discharge available capacities.
- ❑ Connect the test cables to the test object (see figure 5.11).
- ❑ Press the "TEST" key to start the measurement.
- ❑ Press the "TEST" key again to stop the measurement.
- ❑ Save the measuring result by pressing the "MEM" key (optional).

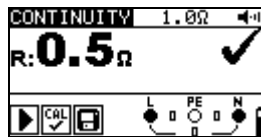

Figure 5.12: Example of a continuity test

Result displayed:

R resistance

5.3.3 Compensation (null balance) of the test cable resistance

This chapter describes how to compensate the test cable resistance in the low-impedance measurement (R_{LOW}) and continuity test (CONTINUITY) functions. Compensation is necessary, because the test cable resistance and the internal resistance of the installation tester might influence the measuring result. The compensation of the test cables is particularly required when using measuring lines of different lengths.

The  icon is displayed, if the test cable resistance has been compensated successfully.

Connection plan

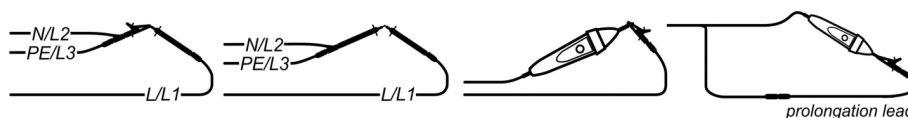

Figure 5.13: Shorted test cables

How to carry out compensation

- ❑ Select the **R_{LOW}** or **CONTINUITY** function.
- ❑ Connect the test cables to the installation tester and short-circuit the test cables (see figure 5.13.)
- ❑ Press the "TEST" key to perform the resistance measurement.
- ❑ Press the "CAL" key to compensate the test cable resistance.

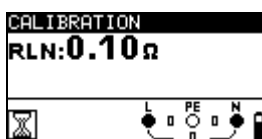



Figure 5.14: Result before calibration



Figure 5.15: Result after calibration

Note:

- The highest value for test cable compensation is 5 Ω . If the resistance is higher, the compensation value will be reset to the default value.

The  icon is displayed, if the test cable resistance has not been compensated.

5.4 RCD testing

The testing of RCDs in RCD-protected installations requires various tests and measurements. The measurements are based on the EN 61557-6 standard.

The following measurements and tests can be performed:

- Contact voltage, tripping time, tripping current and
- Automatic RCD testing

Key function as described in chapter 4.2 Function selector switch

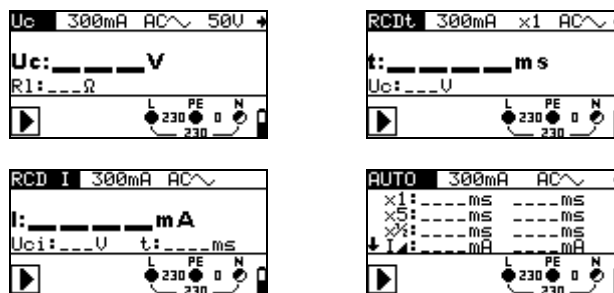

Figure 5.16: RCD tests

Testing parameters

Test	Sub-function [Uc, RCDt, RCD I, AUTO]
I_{ΔN}	Nominal tripping differential current I_{ΔN} [10 mA, 30 mA, 100 mA, 300 mA, 500 mA, 1000 mA]
RCD type	Type [AC, A, F, B, B+] Initial polarity [~ , ~ , ~ , ~ , ⊕ , ⊖] Properties [selective <input checked="" type="checkbox"/> , standard undelayed <input type="checkbox"/> , PRCD, PRCD-S, PRCD-K, EV RCD, MI RCD].
MUL	Multiplier of testing current [½x, 1x, 2 x, 5xI _{ΔN}]
Ulim	Limiting value of contact voltage [25 V, 50 V]

Note:

- The limiting value of the contact voltage can be set only in the Uc sub-function.
- Selective (delayed) RCDs have delayed tripping times. As the contact voltage measurement and other RCD tests influence delayed RCDs, it takes a certain time until they have returned to their normal condition. For this reason, a time delay of 30 seconds is added before the standard tripping test is performed.
- During testing of some portable PRCDs (e.g. PRCD-K) in which the protective conductor is guided through the converter in opposite direction, this portable RCD trips already at the 0.5-fold value of the nominal tripping differential current. The installation tester evaluates the early tripping as "accidental tripping" and aborts the test without any measuring result. If this test has been carried out with a positive result, i.e. it has been proven that the portable PRCD trips at the 0.5-fold value of the nominal tripping differential current and thus the protective conductor is not interrupted, it is possible to continue the test by changing the contacting of the protective conductor. In this case, it is necessary to establish a contact to the protective conductor (PE) of an adjacent socket instead of establishing a contact to the protective conductor (PE) of the coupling socket for further testing. Then, the test can be performed just as for an ordinary RCD.
- Testing of the AC function of the RCDs of types EV and MI is performed in the same way as for a general (non-delayed) RCD.

- ❑ Testing of the DC function of the RCDs of types EV and MI is performed by means of a DC current and it is considered to be passed if the tripping current is between $0.5 \times I_{\Delta NDC}$ and $1.0 \times I_{\Delta NDC}$.
- ❑ **Connection plan**

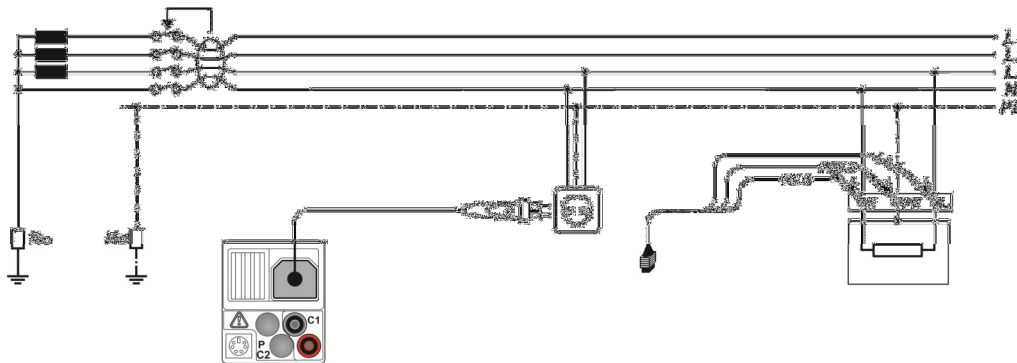

Figure 5.17: Connection of the optional "Commander" test plug (044149) and the three-wire test cable

5.4.1 Contact voltage (Uc)

Leakage current flowing to earth via the protective conductor connection causes a voltage drop at the earthing resistance, i.e. a voltage difference between the PE equipotential bonding and earth. This voltage difference is called contact voltage and is applied to all accessible conductive parts connected to protective earth (PE). The contact voltage always should be lower than the maximum admissible contact voltage. Contact voltage is measured with a testing current lower than $\frac{1}{2} I_{\Delta N}$ in order to avoid tripping of the RCD and then to be normalized to the nominal value $I_{\Delta N}$.

How to perform contact voltage measurements

- ❑ Select the **F/RCD** function by means of the function selector switch.
- ❑ Set the sub-function to **Uc**.
- ❑ Set the testing parameters.
- ❑ Connect the test cables to the test object (see figure 5.17).
- ❑ Press the "TEST" key to start the measurement.
- ❑ Save the measuring result by pressing the "MEM" key (optional).

The contact voltage displayed refers to the rated differential current of the RCD and is multiplied with an appropriate factor for safety reasons. The factor 1.05 is applied in order to avoid a negative tolerance of the result. Table 5.1 describes how the contact voltage is calculated.

RCD type		Contact voltage Uc proportional to	Nominal value $I_{\Delta N}$
AC, EV/MI (AC part)	<input type="checkbox"/>	$1.05 \times I_{\Delta N}$	any
AC	<input checked="" type="checkbox"/>	$2 \times 1.05 \times I_{\Delta N}$	$\geq 30 \text{ mA}$
A, F	<input type="checkbox"/>	$1.4 \times 1.05 \times I_{\Delta N}$	
A, F	<input checked="" type="checkbox"/>	$2 \times 1.4 \times 1.05 \times I_{\Delta N}$	$< 30 \text{ mA}$
A, F	<input type="checkbox"/>	$2 \times 1.05 \times I_{\Delta N}$	
A, F	<input checked="" type="checkbox"/>	$2 \times 2 \times 1.05 \times I_{\Delta N}$	any
B, B+	<input type="checkbox"/>	$2 \times 1.05 \times I_{\Delta N}$	
B, B+	<input checked="" type="checkbox"/>	$2 \times 2 \times 1.05 \times I_{\Delta N}$	

Table 5.1: Relation between Uc and $I_{\Delta N}$

The loop resistance is a purely indicative value and is calculated from the contact voltage (without additional proportional factors). $R_L = \frac{U_c}{I_{\Delta N}}$.

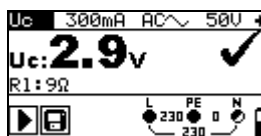

Figure 5.18: Example of a contact voltage measurement

Results displayed:

- Uc**contact voltage
- RL**loop resistance (fault loop resistance)

5.4.2 Tripping time (RCDt)

The tripping time measurement serves to test the sensitivity of the residual current protection devices (RCDs) at different nominal tripping differential currents $I_{\Delta N}$.

How to perform tripping time measurements

- Select the **F/RCD** function by means of the function selector switch.
- Set the sub-function to **RCDt**.
- Set the testing parameters.
- Connect the test cables to the test object (see figure 5.17).
- Press the "TEST" key to start the measurement.
- Save the measuring result by pressing the "MEM" key (optional).

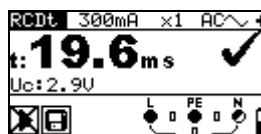

Figure 5.19: Example of a tripping time measurement

Result displayed:

- t**.....tripping time
- Uc**contact Voltage

5.4.3 Tripping current (RCD I)

For tripping current measurement, a continuously increasing fault current serves to determine the limiting sensitivity for RCD tripping. The installation tester increases the fault current in small steps within the whole range as follows:

Norm **EN 60364-4-41**, (SETTINGS mode → RCD TESTING):

RCD type	Increasing fault current		Curve shape
	Initial value	Final value	
AC, EV/MI (AC part)	$0,1 \times I_{\Delta N}$	$1,1 \times I_{\Delta N}$	sinusoidal
A, F ($I_{\Delta N} \geq 30$ mA)	$0,1 \times I_{\Delta N}$	$1,5 \times I_{\Delta N}$	pulsating
A, F ($I_{\Delta N} = 10$ mA)	$0,1 \times I_{\Delta N}$	$2,2 \times I_{\Delta N}$	
B, B+, EV/MI (DC part)	$0,1 \times I_{\Delta N}$	$2,2 \times I_{\Delta N}$	DC

Norm **EN 61008/EN 61009**, (SETTINGS mode → RCD TESTING):

RCD type	Increasing fault current		Curve shape
	Initial value	Final value	
AC, EV/MI (AC part)	$0,2 \times I_{\Delta N}$	$1,1 \times I_{\Delta N}$	sinusoidal
A, F ($I_{\Delta N} \geq 30 \text{ mA}$)	$0,2 \times I_{\Delta N}$	$1,5 \times I_{\Delta N}$	pulsating
A, F ($I_{\Delta N} = 10 \text{ mA}$)	$0,2 \times I_{\Delta N}$	$2,2 \times I_{\Delta N}$	
B, B+, EV/MI (DC part)	$0,2 \times I_{\Delta N}$	$2,2 \times I_{\Delta N}$	DC

The maximum testing current is I_{Δ} (tripping current) or corresponds to the final value, if the RCD does not trip.

How to perform tripping current measurements

- Select the **F/RCD** function by means of the function selector switch.
- Set the sub-function to **RCD I**.
- Set the testing parameters.
- Connect the test cables to the test object (see figure 5.17).
- Press the "TEST" key to start the measurement.
- Save the measuring result by pressing the "MEM" key (optional).



Figure 5.20: Example of a tripping current measurement

Results displayed:

- Itripping current
- Ucicontact voltage at tripping current I or final value, if RCD does not trip
- t.....tripping time

5.4.4 Automatic test

The automatic RCD test is intended to perform a complete RCD test (tripping time at different fault currents, tripping current and contact voltage) in a sequence of automatic tests controlled by the installation tester.

Additional key

HELP / DISPLAY	As soon as measurement is finished, the "HELP" key toggles between the upper and lower part of the result field.
-----------------------	--

How to perform an automatic test

Steps of the automatic test	Note
<ul style="list-style-type: none"> □ Select the F/RCD function by means of the function selector switch. □ Set the sub-function to AUTO. □ Set the testing parameters. □ Connect the test cables to the test object (see figure 5.17). □ Press the "TEST" key to start the measurement. 	Start of test
<ul style="list-style-type: none"> □ Testing with $I_{\Delta N}$, 0° (step 1) 	RCD should trip
<ul style="list-style-type: none"> □ Activating the RCD □ Testing with $I_{\Delta N}$, 180° (step 2) 	RCD should trip
<ul style="list-style-type: none"> □ Activating the RCD □ Testing with $5 \times I_{\Delta N}$, 0° (step 3) 	RCD should trip
<ul style="list-style-type: none"> □ Activating the RCD □ Testing with $5 \times I_{\Delta N}$, 180° (step 4) 	RCD should trip
<ul style="list-style-type: none"> □ Activating the RCD □ Testing with $\frac{1}{2} \times I_{\Delta N}$, 0° (step 5) □ Testing with $\frac{1}{2} \times I_{\Delta N}$, 180° (step 6) 	RCD must not trip RCD must not trip
<ul style="list-style-type: none"> □ Tripping current test, 0° (step 7) 	RCD should trip
<ul style="list-style-type: none"> □ Activating the RCD □ Tripping current test, 180° (step 8) 	RCD should trip
<ul style="list-style-type: none"> □ Activating the RCD □ Save the measuring result by pressing the "MEM" key (optional). 	End of test

Example of the test steps:

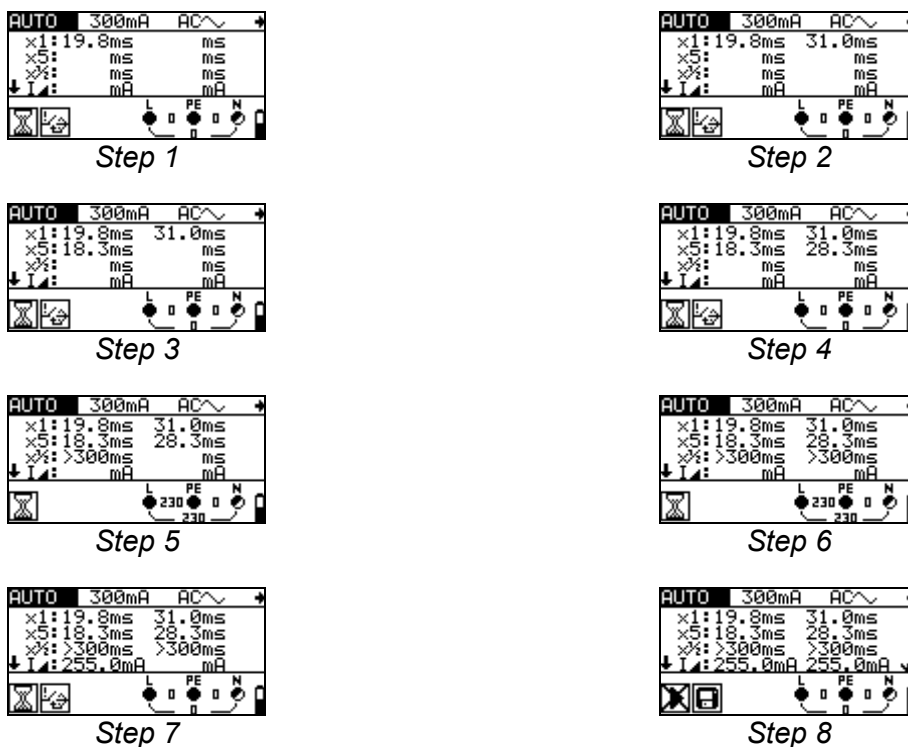

Figure 5.21: Test steps of the automatic test



Figure 5.22: The "HELP" key toggles between the upper and the lower part of the result field.

Results displayed:

- x1step 1 tripping time ($I_{\Delta}=I_{\Delta N}$, 0°)
- x1step 2 tripping time ($I_{\Delta}=I_{\Delta N}$, 180°)
- x5step 3 tripping time ($I_{\Delta}=5 \times I_{\Delta N}$, 0°)
- x5step 4 tripping time ($I_{\Delta}=5 \times I_{\Delta N}$, 180°)
- x $\frac{1}{2}$ step 5 tripping time ($I_{\Delta}=\frac{1}{2} \times I_{\Delta N}$, 0°)
- x $\frac{1}{2}$ step 6 tripping time ($I_{\Delta}=\frac{1}{2} \times I_{\Delta N}$, 180°)
- Lstep 7 tripping current (0°)
- Lstep 8 tripping current (180°)
- U_ccontact voltage for nominal value $I_{\Delta N}$

Notes:

- The automatic test will be stopped immediately, if any invalid condition is detected, e.g. exceedance of the maximum admissible contact voltage or a tripping time outside the admissible range.
- During the automatic testing of RCDs of the types A and F with nominal tripping differential currents of 300 mA, 500 mA and 1000 mA, the test of $5 \times I_{\Delta N}$ will not be carried out. In this case, the test shall be passed, if all other test have been passed.
- The tripping current measurement (I_{Δ} , steps 7 and 8) is not carried out for selective RCDs.
- In the automatic test, the tripping time of RCDs of types B and B+ is measured with a sinusoidal testing current. The tripping current is measured with a smooth DC fault current.

5.5 Loop impedance and prospective short-circuit current

The loop impedance is a complex AC current resistance within a fault loop (earth fault L-PE) consisting of current source, external conductor and protective conductor. The installation tester measures the impedance of the loop and calculates the short-circuit current. The measurement complies with the requirements specified in the EN 61557-3 standard.

Key function as described in chapter 4.2 Function selector switch

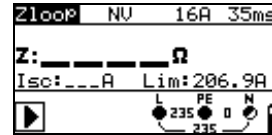

Figure 5.23: Loop impedance

Testing parameters

Test	Selects the loop impedance sub-function [Zloop , Zsrcd]
Fuse type	Selects the fuse type [---, gL/gG, B, C, K, D]
Nominal current	Nominal current of the fuse
Tripping time	Maximum tripping time of the fuse
Lim (limiting value)	Lower limit of the prospective short-circuit current

See Appendix A "Fuse table".

Connection plan

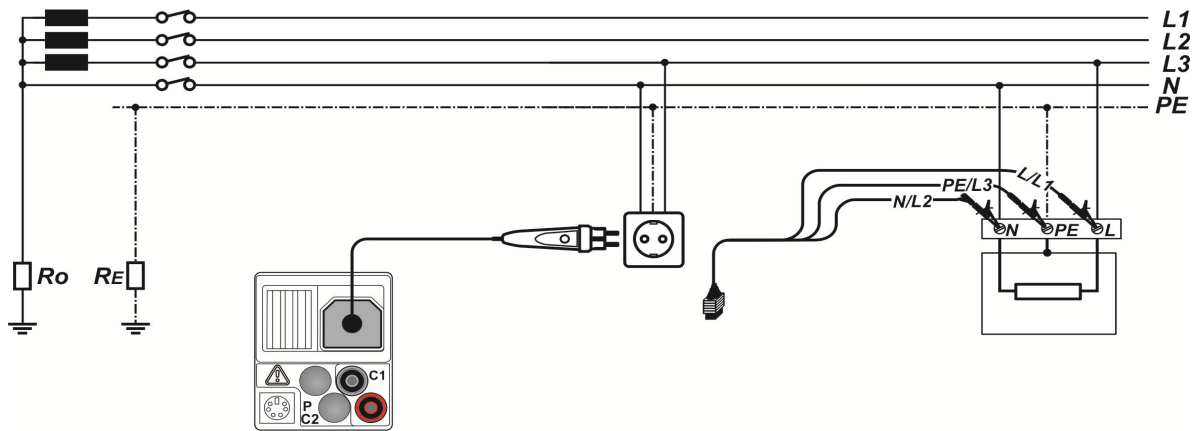

Figure 5.24: Connection of the optional "Commander" test plug (044149) and the three-wire test cable

How to perform loop impedance measurements

- ❑ Select the **Z_s (L-PE)** [English: Z_{LOOP} (L-PE)] function by means of the function selector switch.
- ❑ Set the sub-function to **Z_{loop}** or **Z_{srcd}** (for systems with RCDs).
- ❑ Set the testing parameters.
- ❑ Connect the test cables to the test object (see figure 5.24).
- ❑ Press the "TEST" key to start the measurement.
- ❑ Save the measuring result by pressing the "MEM" key (optional).



Figure 5.25: Example of a loop impedance measurement

Results displayed:

- Z**..... loop impedance
- I_{sc}**..... prospective short-circuit current
- Lim**..... lower limit of the prospective short-circuit current

The prospective short-circuit current I_{sc} is calculated as follows:

$$I_{sc} = \frac{U_n \times k_{sc}}{Z}$$

with:

- U_n..... nominal voltage L-PE (see table below),
- k_{sc}..... correction factor for short-circuit current I_{sc} (see chapter 4.4.6 I_{sc} factor (scaling factor))

U _n	Voltage range (L-PE)
110 V	(93 V ≤ U _{L-PE} ≤ 134 V)
230 V	(185 V ≤ U _{L-PE} ≤ 266 V)

Notes:

- ❑ High fluctuations of the nominal voltage might influence the measuring results (⏏ icon on the LC display). In this case, it is recommended to repeat the measurements and to check whether the measuring results are stable.
- ❑ The loop impedance measurement Z_{loop} trips the residual current protection devices (RCDs).
- ❑ Select the Z_{srcd} measurement in order to prevent the tripping of a residual current protection device (RCD).

5.6 Line impedance and prospective short-circuit current / voltage drop

The line impedance is a complex AC resistance within a current loop (short-circuit L-N or L-L) consisting of current source, external and neutral conductor (single-phase system) or between two external conductors (three-phase system).

The line impedance measurement complies with the requirements specified in the EN 61557-3 standard.

The "voltage drop" sub-function is intended to check whether a voltage in an electrical installation remains above an admissible value, if the maximum nominal current of the upstream fuse is flowing in the circuit. The limiting values are described in the EN 60364-5-52 standard.

Sub-functions:

- **Z_{line}** – line impedance measurement in compliance with EN 61557-3 and
- **ΔU** – voltage drop measurement

Key function as described in chapter 4.2 Function selector switch

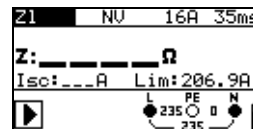

Figure 5.26:
Line impedance

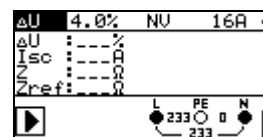

Figure 5.27:
Voltage drop

Testing parameters

Test	Sub-functions [Z_{line}], [ΔU]
Fuse type	Selects the fuse type [---, gL/gG, B, C, K, D]
Nominal current	Nominal current of the fuse
Tripping time	Maximum tripping time of the fuse
Lim (limiting value)	Lower limit of the prospective short-circuit current

See Appendix A "Fuse table".

Additional testing parameter for voltage drop measurement:

ΔU_{MAX}	Maximum voltage drop [3.0 % ÷ 9.0 %]
-------------------------	---

5.6.1 Line impedance and prospective short-circuit current

Connection plan

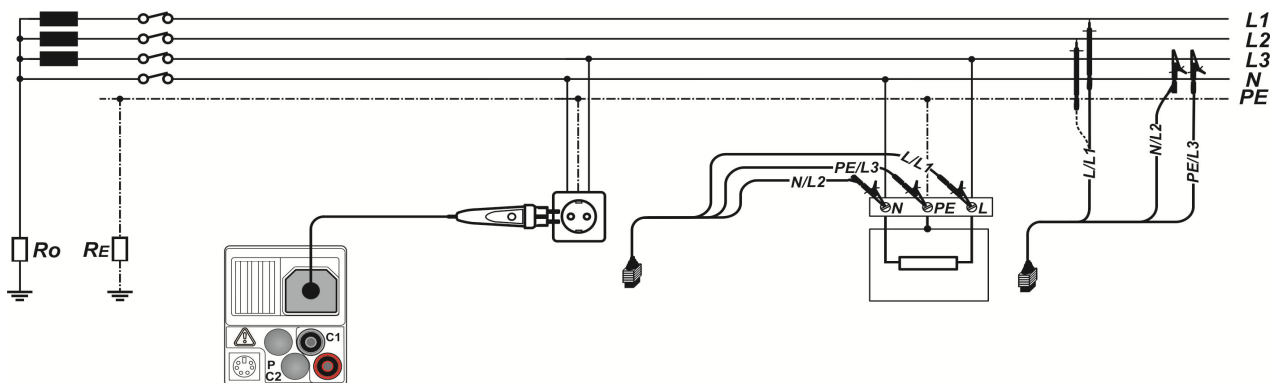

Figure 5.28: Connection of the optional "Commander" test plug (044149) and the three-wire test cable

How to perform line impedance measurements

- ❑ Select the **Z_l(L-N/L)** [English: Z_{LINE} (L-N/L)] function by means of the function selector switch.
- ❑ Set the sub-function to **Z_{line}**.
- ❑ Set the testing parameters.
- ❑ Connect the test cables to the test object (see figure 5.28).
- ❑ Press the "TEST" key to start the measurement.
- ❑ Save the measuring result by pressing the "MEM" key (optional).



Figure 5.29: Example of a line impedance measurement

Results displayed:

- Z**..... line impedance
- Isc**..... prospective short-circuit current
- Lim**..... lower limit of the prospective short-circuit current

The prospective short-circuit current is calculated as follows:

$$I_{sc} = \frac{U_n \times k_{sc}}{Z}$$

with:

- U_n.....nominal voltage L-N or L1-L2 (see table below),
- k_{sc}.....correction factor for short-circuit current I_{sc} (see chapter 4.4.6 I_{sc} factor (scaling factor))

U _n	Voltage range (L-N or L1-L2)
110 V	(93 V ≤ U _{L-N} < 134 V)
230 V	(185 V ≤ U _{L-N} ≤ 266 V)
400 V	(321 V < U _{L-L} ≤ 485 V)

Note:

- High fluctuations of the nominal voltage might influence the measuring results (📉 icon on the LC display). In this case, it is recommended to repeat the measurements and to check whether the measuring results are stable.

5.6.2 Voltage drop

Voltage drop calculation is based on the difference between the line impedance at the measuring point (e.g. socket) and the line impedance at the reference point (e.g. distribution).

Connection plan

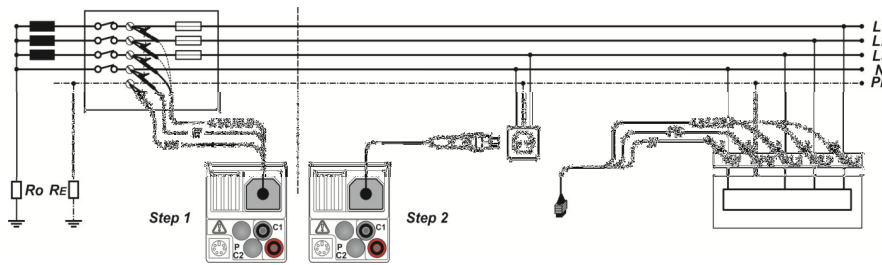

Figure 5.30: Connection of the optional "Commander" test plug (044149) and the three-wire test cable

How to perform voltage drop measurements

Step 1: Measuring the impedance Z_{ref} at the reference point

- Select the Z_L (L-N/L) [English: Z_{LINE} (L-N/L)] function by means of the function selector switch.
- Set the sub-function to ΔU .
- Set the testing parameters.
- Connect the test cables to the test object (see figure 5.30).
- Press the "CAL" key to start the measurement.

Step 2: Measuring the voltage drop at the measuring point

- Set the sub-function to ΔU .
- Set the testing parameters (the fuse type has to be selected).
- Connect the test cables to the test object (see figure 5.30).
- Press the "TEST" key to start the measurement.
- Save the measuring result by pressing the "MEM" key (optional).

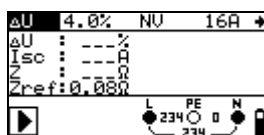

Step 1 - Zref

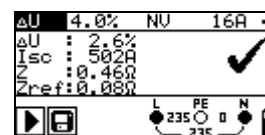

Step 2 - Voltage drop

Figure 5.31: Example of a voltage drop measurement

Results displayed:

- ΔU** voltage drop
- Isc** prospective short-circuit current
- Z** line impedance at the measuring point
- Zref** line impedance at the reference point

The voltage drop is calculated as follows:

$$\Delta U[\%] = \frac{(Z - Z_{REF}) \cdot I_N}{U_N} \cdot 100$$

with:

- ΔU** calculated voltage drop
- Z** line impedance at the measuring point
- Z_{REF}** line impedance at the reference point
- I_N** nominal current of the fuse
- U_N** nominal voltage (see table below)

U _n	Voltage range (L-N or L1-L2)
110 V	(93 V ≤ U _{L-N} < 134 V)
230 V	(185 V ≤ U _{L-N} ≤ 266 V)
400 V	(321 V < U _{L-L} ≤ 485 V)

Notes:

- ❑ If the reference impedance is not set, Z_{REF} is assumed to be 0.00 Ω.
- ❑ The Z_{REF} value is deleted (set to 0.00 Ω) by pressing the "CAL" key, if the installation tester is not connected to a voltage source.
- ❑ The I_{SC} value is calculated as described in chapter 5.6.1 "Line impedance and prospective short-circuit current".
- ❑ If the voltage measured is outside the ranges listed in the table above, the ΔU value will not be calculated.
- ❑ High fluctuations of the nominal voltage might influence the measuring results (⏏ icon on the LC display). In this case, it is recommended to repeat the measurements and to check whether the measuring results are stable.

5.7 Earthing resistance

An adequate and reliably effective earth connection is an important prerequisite for the correct functioning and safety of electrical installations.

In combination with the optional earthing kit (044113), it is possible to perform earthing resistance measurements at main earthing systems, lightning arresters and local earth connections. The measurement complies with the EN 61557-5 standard.

Earthing resistance measurement is performed using the three-wire measuring method by means of two earth rods.

Key function as described in chapter 4.2 Function selector switch

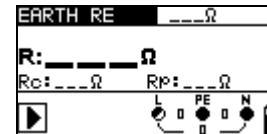

Figure 5.32: Earthing resistance

Testing parameters

Limiting value	Maximum resistance [without limits (---), 1 Ω ÷ 5 kΩ]
-----------------------	---

How to perform earthing resistance measurements

- ❑ Select the **R_E** function by means of the function selector switch. The display shows **EARTH RE**.
- ❑ Set the limiting value (optional).
- ❑ Connect the test cables to the test object (see figure 5.33 and 5.34)
- ❑ Press the "TEST" key to start the measurement.
- ❑ Save the measuring result by pressing the "MEM" key (optional).

Connection plan

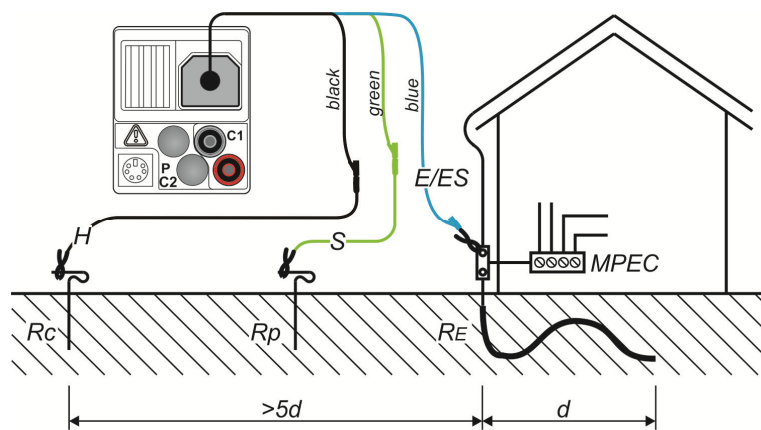

Figure 5.33: Connection of the optional earthing kit (044113) – Measurement of the main earthing system

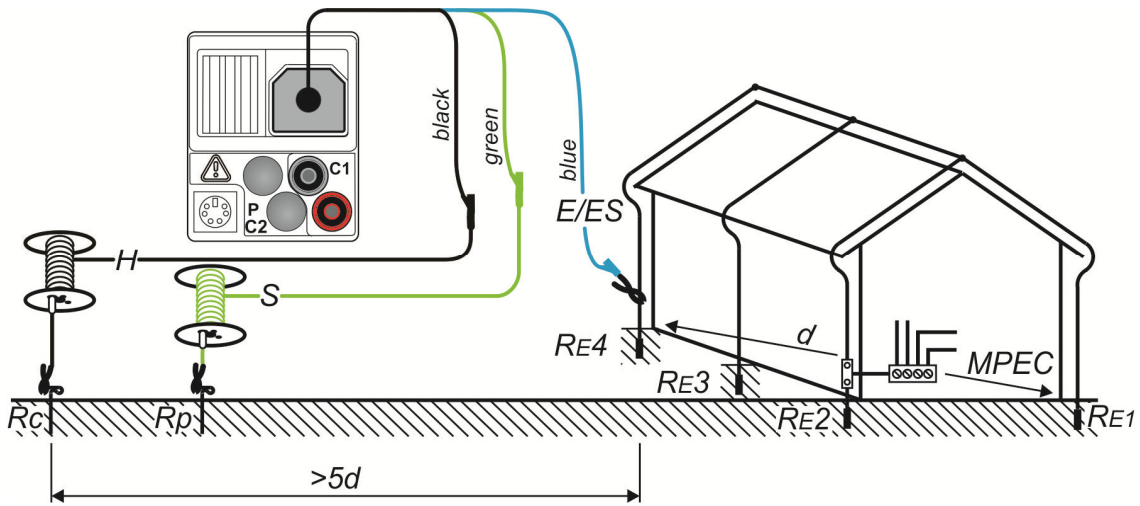

Figure 5.34: Connection of the optional earthing kit (044113) – Measurement at the lightning arrester



Figure 5.35: Example of an earthing resistance measurement

Results displayed:

- R** earthing resistance
- R_p** resistance of the S probe, probe resistance (potential)
- R_c** resistance of the H probe, auxiliary earth electrode resistance (current)

Notes:

- ❑ An excessive resistance of the S and H probes might influence the measuring results. In this case, the warnings “Rp” and “Rc” will be displayed. The results will not be evaluated with "PASS" / "FAIL".
- ❑ High parasitic currents and interference voltages might influence the measuring results. In this case, the tester displays the  warning.
- ❑ The probes must be positioned with sufficient distance from the test object. The distance between the earth connection (E/ES) and the probe (H) should be at least five times larger than the depth or length of the earth connection (see figures 5.33 and 5.34).

5.8 Testing the protective conductor connection (PE)

In case of new or modified installations, it might happen that the protective conductor (PE) and the external conductor L (phase) have been accidentally reversed. This is a very dangerous situation! For this reason, it is important to check whether a dangerous phase voltage is applied to the protective conductor connection.

The test of the protective conductor connection is performed automatically for the **Zline (L-N/L)**, **Zloop (L-PE)** and **RCD** measuring functions by touching (> 1 second) the silver "TEST" key of the installation tester, of the "Commander" test probe or the optional "Commander" test plug (044149).

Examples of incorrect wiring of the protective conductor connection (PE)

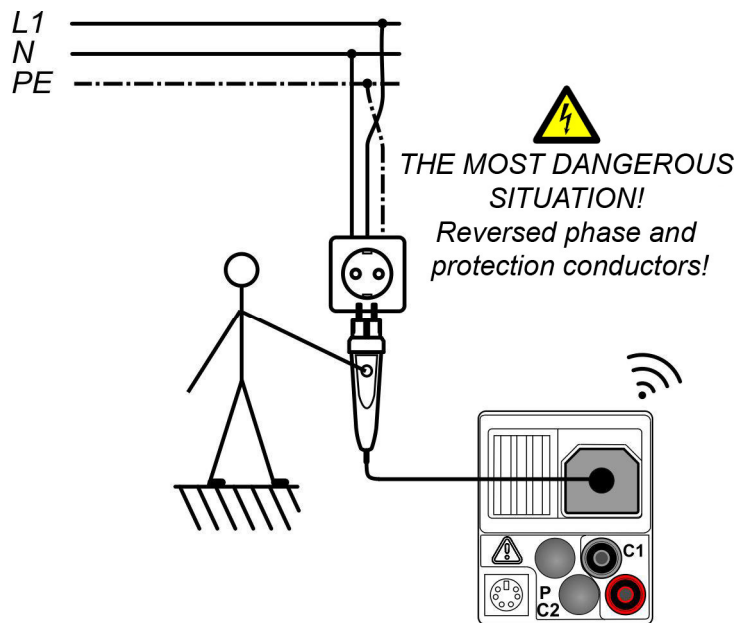

Figure 5.36: Reversed L and PE conductors – Phase voltage at the PE conductor is detected by touching the "TEST" key of the "Commander" test plug (optional).

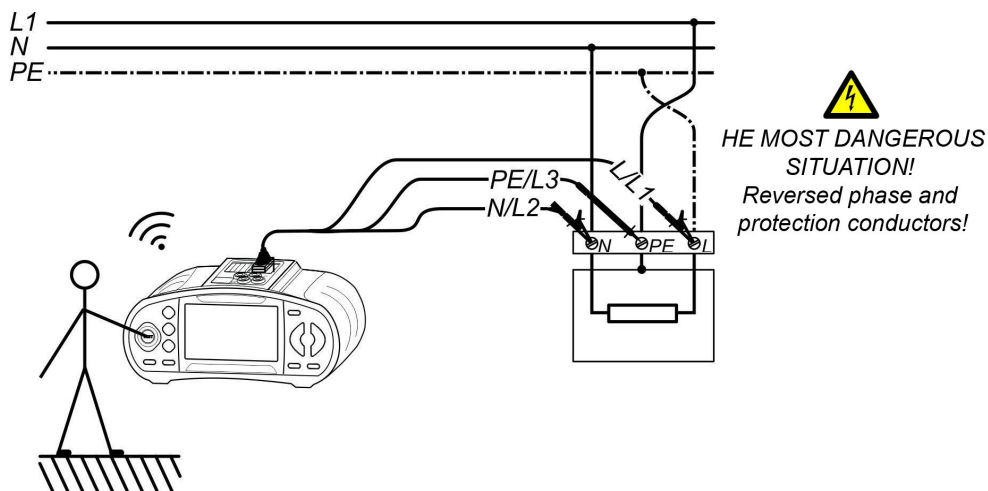



Figure 5.37: Reversed L and PE conductors – Phase voltage at the PE conductor is detected by touching the "TEST" key of the installation tester

Testing the protective conductor connection (PE)

- ❑ Select the **Z_I (L-N/L)** [English: Z_{LINE}], **Z_S (L-PE)** [English: Z_{LOOP}] or **FI/RCD** function by means of the function selector switch.
- ❑ Connect the test cables to the test object (see figure 5.36 and 5.37).
- ❑ Touch the silver contact electrode of the "TEST" key for at least two seconds.
- ❑ If phase voltage is connected to the PE connection, the  warning is shown on the LC display of the installation tester and the buzzer sounds. Further measurements in the **Z_{loop} (L-PE)** and **RCD** functions are blocked.

Warning:

- ❑ If the phase voltage is detected at the protective conductor connection (PE), immediately stop all measurements and make sure that the fault will be eliminated.

Notes:

- ❑ The protective conductor connection can only be tested in the **Z_I (L-N/L)** [English: Z_{LINE}], **Z_S (L-PE)** [English Z_{LOOP}] or **FI/RCD** positions of the function selector switch.
- ❑ A phase voltage at the protective conductor will not be detected, if the operator's body is completely insulated from the floor or the walls!
- ❑ See Appendix C "Commander".

5.9 TRMS current by means of current clamp adapter

This function allows the measurement of load currents and leakage currents by means of the optional current clamp adapters BENNING CC 1 and BENNING CC 3 using the TRMS (TRUE RMS) measuring method. This measuring method guarantees correct measuring results even in case of non-sinusoidal signals.

Key function as described in chapter 4.2 Function selector switch

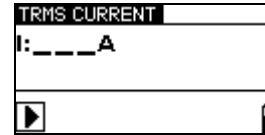

Figure 5.38: Current

Connection plan

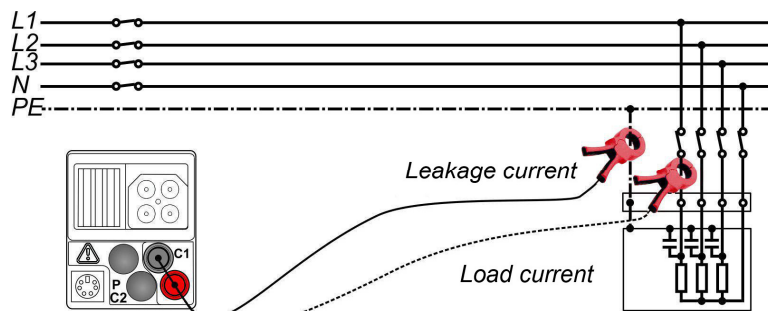

Figure 5.39: Connection of the optional current clamp adapter BENNING CC 1 or BENNING CC 3

How to perform current measurements

- ❑ Set the current clamp adapter as described in chapter 4.4.9 and connect it to measuring input C1.
- ❑ Select the **A** function by means of the function selector switch. The display shows **CURRENT**.
- ❑ Clamp the single-wire conductor by means of the current measuring clamp (see figure 5.39).
- ❑ Press the "TEST" key to start the measurement.
- ❑ Press the "TEST" key again to stop the measurement.
- ❑ Save the measuring result by pressing the "MEM" key (optional).

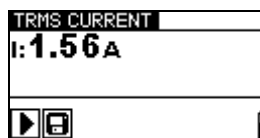

Figure 5.40: Example of a current measurement

Result displayed:

I current

5.10 Single-fault leakage current (ISFL) in IT networks

The IT system is a power supply network which is insulated from the protective conductor. It is an ungrounded power supply network. Either the network is not connected to earth directly or it is connected to earth via a relatively high impedance. It is mainly used in areas requiring additional protection against electrical accidents. A typical area of application are medical operating rooms.

A first insulation fault between an external conductor and earth represents earthing of this conductor. In this case, there is neither a potential difference between conductive housings and earth nor an electric circuit to the transformer closed via earth.

The measurement of the single-fault leakage current is carried out in order to measure the maximum current which might flow from the tested line (external conductor) to the protective conductor. This current flows through the insulating resistance and the phase-to-earth capacities between the other lines (external conductors) and the protective conductor, if the single fault is applied as short-circuit between the tested line and PE.

Key function as described in chapter

4.2 Function selector switch

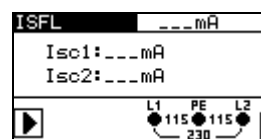

Figure 5.41: Single-fault leakage current (ISFL)

Testing parameters

Limiting value	Maximum single-fault leakage current [without limits (---), 3.0 mA ÷ 20.0 mA]
-----------------------	---

Connection plan

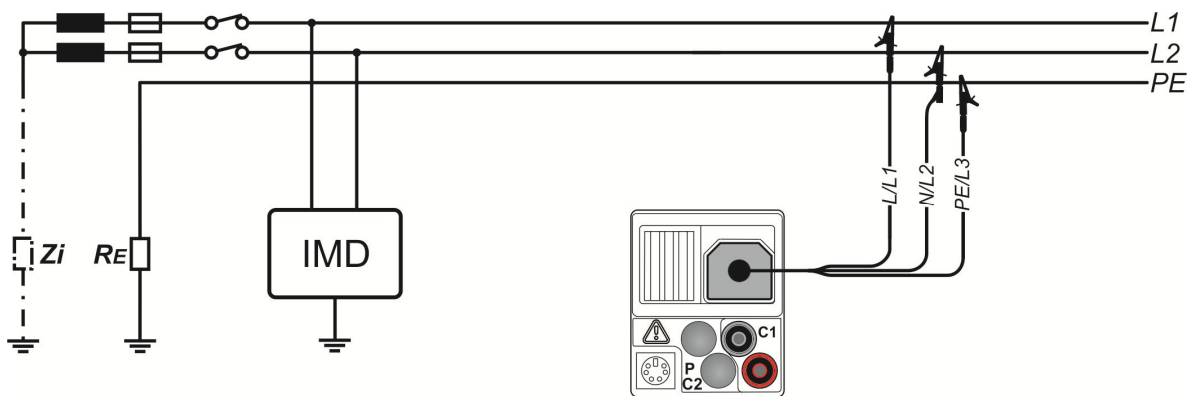

Figure 5.42: Connection of the three-wire test cable

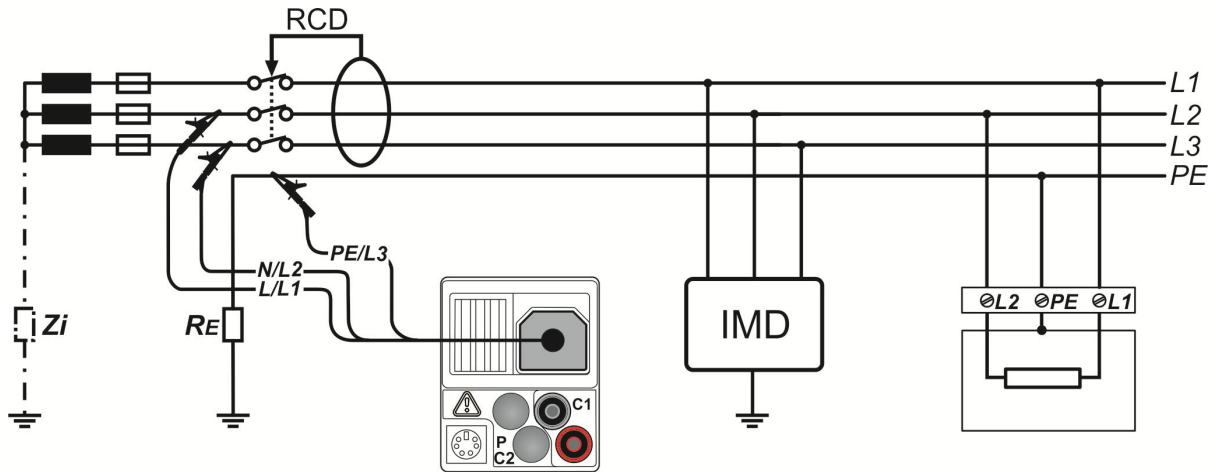

Figure 5.43: Connection of the three-wire test cable in RCD-protected installations

How to perform single-fault leakage current measurements

- ❑ Set the earthing system according to chapter 4.4.4 to the IT network type.
- ❑ Select the **R_{ISO}** function by means of the function selector switch.
- ❑ Set the sub-function to **ISFL**.
- ❑ Set the limiting value (optional).
- ❑ Connect the test cables to the test object (see figure 5.42 and 5.43).
- ❑ Press the "TEST" key to start the measurement.
- ❑ Save the measuring result by pressing the "MEM" key (optional).



Figure 5.44: Examples of single-fault leakage current measurements

Results displayed:

- I_{sc1}** single-fault leakage current at single fault (earth fault) between L1 and protective conductor (PE)
- I_{sc2}** single-fault leakage current at single fault (earth fault) between L2 and protective conductor (PE)

5.11 Luminous intensity

Luminous intensity measurement can be used for the planning and installation of interior and exterior lighting systems. The optional BENNING luxmeter type B (044111) is connected to the RS232 interface.

Key function as described in chapter 4.2 Function selector switch

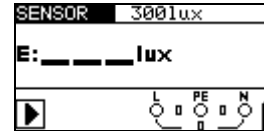

Figure 5.45: Luminous intensity

Testing parameters

Limiting value	Minimum illumination [without limits (---), 0.1 lux ÷ 20 klux]
-----------------------	--

Sensor positioning

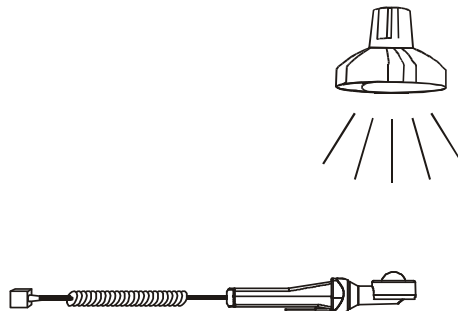

Figure 5.46: Positioning of the luxmeter

How to perform luminous intensity measurements

- Select the **LUX** function by means of the function selector switch. The display shows **SENSOR**.
- Set the limiting value (optional).
- Connect the luxmeter to the PS/2 port of the installation tester.
- Switch the luxmeter on and position it underneath the light source (see figure 5.46).
- Press the "TEST" key to start the measurement.
- Save the measuring result by pressing the "MEM" key (optional).



Figure 5.47: Example of a luminous intensity measurement

Result displayed:

E..... luminous intensity

Notes:

- ❑ Shadows and irregular exposure to light might influence the measuring result!
- ❑ Artificial light sources reach their full capacity (see Technical Data of the light sources) only after a certain time and therefore should be switched on until they reach this capacity before carrying out measurements.

6 Management of measured values

6.1 Memory structure

After measurement, the measuring results including all relevant measuring parameters can be stored in the memory of the installation tester.

The memory of the installation tester is divided into four levels with each level offering 199 storage locations. The number of measurements which can be stored in one storage location is not limited.

The installation structure field describes the storage location of the measurement (which object, block, fuse and measuring point) and how it can be accessed.

The measuring result field provides information on the type and number of measurements belonging to the selected storage location (object, block, fuse and measuring point).

RECALL RESULTS
[OBJ]OBJECT 001
[BLK]BLOCK 002
[FUS]FUSE 003
[CON]CONNECTION 004
> No. : 1/36
VOLTAGE TRMS

Figure 6.1: Installation structure field and measuring result field

The memory structure offers the following advantages

- ❑ The measuring results can be structured and stored corresponding to a typical electrical installation.
- ❑ The structure of the electrical system to be tested can be created by means of the PC software BENNING PC-Win IT 130 and can be transmitted to the BENNING IT 130 installation tester (upload of installation structures).
- ❑ Easy browsing through installation structures and corresponding measuring results
- ❑ Test reports and test certificates can be created by means of the BENNING PC-Win IT 130 logging software after the measuring results have been downloaded to a PC.

Installation structure field

RECALL RESULTS	Memory menu
[OBJ]OBJECT 001 [BLK]BLOCK 002 [FUS]FUSE 003 [CON]CONNECTION 004	Installation structure field
[OBJ]OBJECT 001	1st level: OBJECT: Default name of the storage location 001: No. of the storage location
[BLK]BLOCK 002	2nd level: BLOCK: Default name of the storage location 002: No. of the storage location
[FUS]FUSE 003	3rd level: FUSE: Default name of the storage location 003: No. of the storage location
[CON]CONNECTION 004	4th level: CONNECTION (measuring point): Default name of the storage location 004: No. of the storage location
No.: 20 [132]	Number of measurements stored in the selected storage location [number of measurements stored in the selected storage location and in subordinate storage locations]

Measuring result field

VOLTAGE TRMS

Type of measurement stored in the selected storage location

No.: 1/36

No. of the selected measurement / number of all measurements for each storage location

Example of a typical installation structure in the BENNING IT 130 installation tester:

[OBJ] OBJECT 001

[BLO] BLOCK 001

[FUS] FUSE 001

[CON] MEASURING POINT 001

No.: 1/3

R ISO

Example of a customer-specific installation structure in the BENNING IT 130 installation tester:

[OBJ] Customer Meyer

[BLO] Distributor of ground floor

[FUS] F1 kitchen

[CON] Socket 1

No.: 1/3

R ISO

Note:

The customer-specific installation structure has been created by means of the BENNING PC-Win IT 130 logging software and then downloaded to the BENNING IT 130 installation tester. Once created, installation structures can be stored in the BENNING PC-Win IT 130 logging software and transmitted once again to the installation tester for periodic testing.

6.2 Saving measuring results

After measurement, the measuring results and the corresponding parameters can be saved ( icon appears on the LC display). Press the "MEM" key to enter the memory menu.

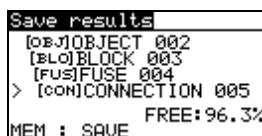

Figure 6.2: Memory menu

FREE: 96.3%

Free memory capacity for saving measuring results

Keys used in the installation structure field:

TAB	Selects the storage location (object / block / fuse / measuring point)
UP / DOWN	Selects the no. of the selected storage location (1 to 199)
MEM	Saves the measuring results to the selected storage location
ESC / TEST / function selector switch	Back / cancel without saving

Notes:

- The installation tester automatically suggests the last selected storage location for saving a new measuring result.
- If you want to save the measuring result to the same storage location as the previous one, press the "MEM" key twice.

6.3 Recalling measuring results

Press the "MEM" key, if there is no measuring result for saving yet, or select "MEMORY", "RECALL RESULTS" in the "SETTINGS" menu.

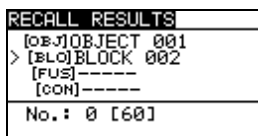

Figure 6.3:

Recall memory menu

– installation structure field selected

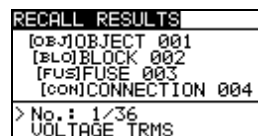

Figure 6.4:

Recall memory menu

– measuring result field selected

Keys used in the installation structure field:

TAB	Selects the storage location (object / block / fuse / measuring point)
UP / DOWN	Selects the no. of the selected storage location (1 to 199)
ESC / function selector switch	Back / cancel to the selected measuring function
TEST / MEM	Selects the corresponding measuring result field

Keys used in the measuring result field:

UP / DOWN	Selects the measurement stored
ESC / TAB	Back / cancel to the installation structure field
Function selector switch	Back / cancel to the selected measuring function
TEST / MEM	Recalls the selected measuring results

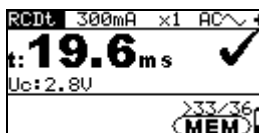

Figure 6.5: Recall of measuring results stored

Keys used in the measuring result field (measuring results are displayed)

UP / DOWN	Recalls measuring results stored in the selected storage location
MEM / ESC	Back / cancel to the measuring result field
TEST	Back / cancel to the installation structure field
Function selector switch	Back / cancel to the selected measuring function

6.4 Deleting measuring results

6.4.1 Deleting the entire measured value memory

Select the **SETTINGS** mode by means of the function selector switch.
 Select "**CLEAR ALL MEMORY**" in the "**MEMORY**" menu. The following warning will be displayed:

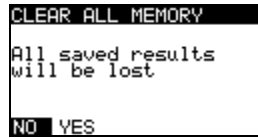

Figure 6.6: Clear all memory

Keys used:

UP / DOWN	Toggles between NO and YES
TEST	Confirms deleting the entire measured value memory
ESC / function selector switch	Back / cancel to the "MEMORY" menu

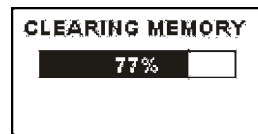

Figure 6.7: Deleting the measured value memory

6.4.2 Deleting all measurements of each storage location and subordinate storage locations

Select the **SETTINGS** mode by means of the function selector switch.
 Select "**DELETE RESULTS**" in the "**MEMORY**" menu.

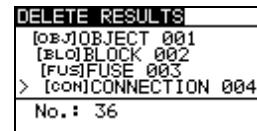
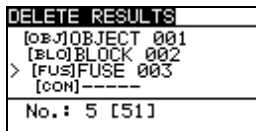

Figure 6.8: Deleting all measurements of each storage location and subordinate storage locations

Keys used in the installation structure field:

TAB	Selects the storage location (object / block / fuse / measuring point)
UP / DOWN	Selects the no. of the selected storage location (1 to 199)
Function selector switch	Back / cancel to the selected measuring function
ESC	Back / cancel to the "MEMORY" menu
TEST	Enters a dialog box for deleting all measurements of the selected storage location and its subordinate storage locations. Press the key again to delete all measurements of this storage location and its subordinate storage locations.

6.4.3 Deleting an individual measurement

Select the **SETTINGS** mode by means of the function selector switch.
 Select "DELETE RESULTS" in the "MEMORY" menu.

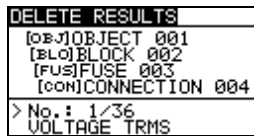

Figure 6.9: Deleting an individual measurement (installation structure field selected)

Keys used in the installation structure field:

TAB	Selects the storage location (object / block / fuse / measuring point)
UP / DOWN	Selects the no. of the selected storage location (1 to 199)
Function selector switch	Back / cancel to the selected measuring function
ESC	Back / cancel to the "MEMORY" menu
MEM	Enters the measuring result field of individual measurements

Keys used in the measuring result field:

UP / DOWN	Selects an individual measurement
TEST	Enters a dialog box for deleting an individual measurement. Press the key again to delete the individual measurement.
TAB / ESC	Back / cancel to the installation structure field
Function selector switch	Back / cancel to the selected measuring function



Figure 6.10:

Deleting an individual measurement

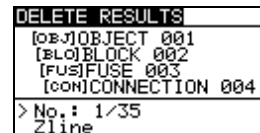

Figure 6.11:

Display after the measurement has been deleted

6.5 Renaming installation structure fields

6.5.1 Renaming installation structure fields by means of the PC software

The default installation structure field of the installation tester are "Object", "Block", "Fuse" and "Measuring point (CON)".

In the BENNING PC-Win IT 130 logging software, the default installation structure field can be renamed with customer-specific names and can be adapted to the installation to be tested. Once created, the installation structures can be stored in the BENNING PC-Win IT 130 logging software and transmitted to the BENNING IT 130 installation tester. Please refer to the help menu of the BENNING PC-Win IT 130 logging software for further information on how to transmit customer-specific installation structures to the installation tester.

RECALL RESULTS
[OBJ]APARTMENT1
[BLK]MAIN-BOARD
> [FUS]KITCHEN
No. : 72

Figure 6.12: Example of a customer-specific installation structure

6.5.2 Renaming the installation structure fields by means of the barcode scanner

The default installation structure field of the installation tester are "Object", "Block", "Fuse" and "Measuring point (CON)".

If the installation tester is in the "**SAVE RESULTS**" menu, the identification no. or the designation of the measuring point can be scanned by means of a barcode scanner.

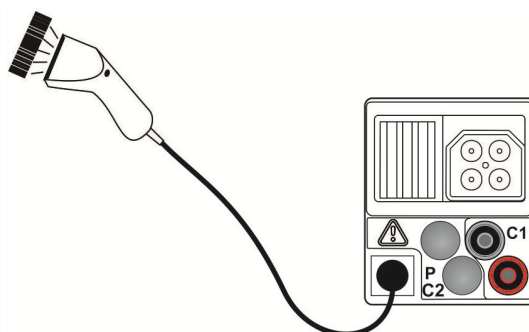

Figure 6.13: Connection of the optional barcode scanner (009371)

Renaming the storage location

- ❑ Connect the optional barcode scanner to the installation tester.
- ❑ Carry out the measurement, press the "**MEM**" key and select the storage location to be renamed in the "**SAVE RESULTS**" menu.
- ❑ Scan the identification no. or the designation of the measuring point from the barcode label in order to rename the installation structure field. The installation tester confirms the receipt by two short acoustic signals and displays the identification no. or the designation of the measuring point.

Note:

- ❑ Please use barcode scanners only which have been approved by BENNING.

6.6 USB and RS232 interface

The installation tester is provided with the two communication interfaces USB and RS 232. The transmission mode is selected automatically by the installation tester depending on the interface used. Here, the USB interface is given priority.

The stored measuring results can be transmitted to a PC by means of the BENNING PC-Win IT 130 logging software. The PC software automatically recognizes the installation tester and thus allows data transmission between the installation tester and the PC.

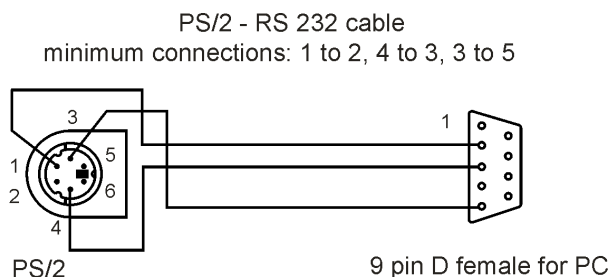

Figure 6.14: Pin assignment of the serial RS232 cable

How to set up a USB or RS232 connection

- ❑ RS232 interface: Connect the serial PS/2-RS232 interface cable to a COM port of the PC and to the PS/2 connector of the installation tester.
- ❑ USB interface: Connect the USB cable to a USB port of the PC and to the USB port of the installation tester.
- ❑ Switch on both the PC and the installation tester.
- ❑ Start the BENNING PC-Win IT 130 program.
- ❑ The PC and the installation tester automatically recognize each other.
- ❑ The installation tester is prepared for communication with a PC.

The BENNING PC-Win IT 130 logging software is compatible with Windows XP, Windows Vista, Windows 7 and Windows 8.

Note:

- ❑ Before using the USB interface, the USB driver should be installed on the PC. Please refer to the installation CD for installation instructions of the USB driver.

7 Maintenance

Unauthorized persons are not allowed to open the installation tester. The installation tester does not contain any replaceable components except for the batteries / storage batteries and the fuse F1.

7.1 Fuse F1 replacement

Three fuses are located behind the rear cover of the installation tester. Only the fuse F1 can be replaced.

If one of the fuses F2 or F3 has blown, the device must not be used anymore. In this case, the device must be sent to BENNING for inspection and repair.

- ❑ **F1**
M 0.315 A / 250 V, 20×5 mm (757211)
This fuse is intended to protect the internal switching circuits for low-impedance measurement / continuity test, if during measurement the test probes are accidentally connected to the mains voltage.

Please refer to chapter 3.3 "*Rear panel*" for information on the position of the fuse F1.

Warnings:

- ❑ Disconnect all test cables and switch off the installation tester before opening the battery / fuse compartment, as dangerous voltages are applied to the installation tester!
- ❑ Replace the defective fuse by original fuses only, because otherwise the installation tester or the accessories might get damaged and / or the operator's safety might be impaired!

7.2 Cleaning

The housing does not require any specific maintenance. Clean the surface of the installation tester or the accessories by means of a soft cloth slightly moistened with soap water or alcohol. After cleaning, let the installation tester or accessories dry completely before using them.

Warnings:

- ❑ Do not use any liquids based on benzine or hydrocarbons!
- ❑ Do not spill any cleaning liquids on the installation tester!

7.3 Periodic calibration

It is important to calibrate the installation tester regularly to make sure that the technical data listed in this operating manual are guaranteed. BENNING waarborgt de naleving van de in de gebruiksaanwijzing vermelde technische gegevens en nauwkeurigheidsinformatie gedurende het 1ste jaar na de leveringsdatum. It is recommended to calibrate the installation tester once a year. Calibration must be carried out by an authorized technician only. Please contact your specialty retailer or the BENNING Service Center for further information.

7.4 Service

For repairs or service, please contact your specialty retailer or the BENNING Service Center.

BENNING Elektrotechnik und Elektronik GmbH & Co. KG
Robert-Bosch-Str. 20
D - 46397 Bocholt

BENNING Helpdesk phone no.: +49 (0)2871 - 93 - 555

www.benning.de • hotline@benning.de

8 Technical data

8.1 Insulating resistance

Insulating resistance (nominal voltages of 50 V_{DC}, 100 V_{DC} and 250 V_{DC})

Measuring range according to EN 61557-2: 0.15 MΩ ÷ 199.9 MΩ

Measuring range (MΩ)	Resolution (MΩ)	Accuracy
0.00 ÷ 19.99	0.01	±(5 % of the measured value + 3 digits)
20.0 ÷ 99.9	0.1	±(10 % of the measured value)
100.0 ÷ 199.9		±(20 % of the measured value)

Insulating resistance (nominal voltages of 500 V_{DC} and 1000 V_{DC})

Measuring range according to EN 61557-2: 0.15 MΩ ÷ 999 MΩ

Measuring range (MΩ)	Resolution (MΩ)	Accuracy
0.00 ÷ 19.99	0.01	±(5 % of the measured value + 3 digits)
20.0 ÷ 199.9	0.1	±(5 % of the measured value)
200 ÷ 999	1	±(10 % of the measured value)

Voltage

Measuring range (V)	Resolution (V)	Accuracy
0 ÷ 1200	1	±(3 % of the measured value + 3 digits)

Nominal voltages 50 V_{DC}, 100 V_{DC}, 250 V_{DC}, 500 V_{DC}, 1000 V_{DC}

Open-circuit voltage -0 % / +20 % of the nominal voltage

Measuring current min. 1 mA at R_N=U_N×1 kΩ/V

Short-circuit current max. 3 mA

Number of possible tests > 1200, with fully charged battery / storage battery

Automatic discharge after test.

The accuracy specified shall apply for the use of the three-wire test cable and shall apply up to 100 MΩ for the use of the "Commander" test probe.

The accuracy specified shall apply up to 100 MΩ for a relative air humidity > 85 %.

If the installation tester gets wet, the results might be affected. In this case, it is recommended to let the installation tester and its accessories dry for at least 24 hours.

The maximum error under operating conditions corresponds to the maximum error under reference conditions ± 5 % of the measured value.

8.2 Low-impedance resistance / continuity test

8.2.1 Low-impedance resistance R LOW

Measuring range according to EN 61557-4: 0.16 Ω ÷ 1999 Ω

Measuring range R (Ω)	Resolution (Ω)	Accuracy
0.00 ÷ 19.99	0.01	$\pm(3\%$ of the measured value + 3 digits)
20.0 ÷ 199.9	0.1	$\pm(5\%$ of the measured value)
200 ÷ 1999	1	

Measuring range R+, R- (Ω)	Resolution (Ω)	Accuracy
0.0 ÷ 199.9	0.1	$\pm(5\%$ of the measured value + 5 digits)
200 ÷ 1999	1	

Open-circuit voltage6.5 V DC ÷ 9 V DC

Measuring current.....min. 200 mA for a load resistance of 2 Ω

Test cable compensation.....up to 5 Ω

Number of possible tests> 2000, with fully charged batteries / storage batteries

Automatic polarity reversal of the testing voltage.

8.2.2 Continuity test

Measuring range (Ω)	Resolution (Ω)	Accuracy
0.0 ÷ 19.9	0.1	$\pm(5\%$ of the measured value + 3 digits)
20 ÷ 1999	1	

Open-circuit voltage6.5 V DC ÷ 9 V DC

Short-circuit currentmax. 8.5 mA

Test cable compensation.....up to 5 Ω

8.3 Residual current protection devices (RCDs)

8.3.1 General data

Nominal tripping differential current (A, AC).. 10 mA, 30 mA, 100 mA, 300 mA, 500 mA, 1000 mA
 Nominal tripping differential current (EV, MI) 30 mA AC, 6 mA DC
 Accuracy..... -0 / +0,1·I_Δ; I_Δ = I_{ΔN}, 2×I_{ΔN}, 5×I_{ΔN}
 -0.1·I_Δ / +0; I_Δ = 0.5×I_{ΔN}
 AS / NZS: ± 5 %
 Shape of testing current..... sinusoidal (type AC, type EV/MI [AC part]),
 pulsating (type A, type F),
 smooth direct current (type B, type B+,
 type EV/MI [DC part]),
 DC offset for pulsating testing current..... 6 mA (typical)
 RCD type..... undelayed, delayed (S)
 Initial polarity of the testing current 0° or 180°
 Voltage range 93 V ÷ 134 V (45 Hz ÷ 65 Hz)
 185 V ÷ 266 V (45 Hz ÷ 65 Hz)

Current selection for RCD testing (r.m.s. value calculated for 20 ms) according to IEC 61009:

I _{ΔN} (mA)	I _{ΔN} × 1/2			I _{ΔN} × 1			I _{ΔN} × 2			I _{ΔN} × 5			RCD I _Δ		
	AC	A, F	B, B+	AC	A, F	B, B+	AC	A, F	B, B+	AC	A, F	B, B+	AC	A, F	B, B+
10	5	3,5	5	10	20	20	20	40	40	50	100	100	✓	✓	✓
30	15	10,5	15	30	42	60	60	84	120	150	212	300	✓	✓	✓
100	50	35	50	100	141	200	200	282	400	500	707	1000	✓	✓	✓
300	150	105	150	300	424	600	600	848	-	1500	-	-	✓	✓	✓
500	250	175	250	500	707	1000	1000	1410	-	2500	-	-	✓	✓	✓
1000	500	350	500	1000	1410	-	2000	-	-	-	-	-	✓	✓	-

„-“.....not applicable
 Type ACsinusoidal testing current
 Type A, type Fpulsating testing current
 Type B, type B+testing current is a smooth direct current

I _{ΔN} (mA)	I _{ΔN} × 1/2	I _{ΔN} × 1	I _{ΔN} × 2	I _{ΔN} × 5	RCD I _Δ	
	EV/MI (AC part)	EV/MI (AC part)	EV/MI (AC part)	EV/MI (AC part)	EV/MI (AC part)	EV/MI (DC part)
30 AC	15	30	60	150	✓	-
6 DC	-	-	-	-	-	✓

„-“.....not applicable
 Type EV, MI (AC part)sinusoidal testing current
 Type EV, MI (DC part)testing current is a smooth direct current

8.3.2 Contact voltage (Uc)

Measuring range according to EN 61557-6: 20.0 V ÷ 31.0 V for limiting value of 25 V

Measuring range according to EN 61557-6: 20.0 V ÷ 62.0 V for limiting value of 50 V

Measuring range (V)	Resolution (V)	Accuracy
0.0 ÷ 19.9	0.1	(-0 % / +15 %) of the measured value ± 10 digits
20.0 ÷ 99.9	0.1	(-0 % / +15 %) of the measured value

The specified accuracy shall apply for stable mains voltages and protective conductor connections without any interference voltages.

Testing current..... max. $0.5 \times I_{\Delta N}$

Limiting value for contact voltage..... 25 V, 50 V

The specified accuracy shall apply to the entire measuring range.

8.3.3 Tripping time (RCD t)

The entire measuring range complies with the requirements specified in the EN 61557-6 standard.

Measuring range (ms)	Resolution (ms)	Accuracy
0.0 ÷ 40.0	0.1	±1 ms
0.0 ÷ max. time *	0.1	±3 ms

* The maximum measuring duration depends on the RCD testing standard selected (see chapter 4.4.5 RCD testing) – The specification shall apply to maximum times >40 ms.

Testing current..... $\frac{1}{2} \times I_{\Delta N}$, $I_{\Delta N}$, $2 \times I_{\Delta N}$, $5 \times I_{\Delta N}$

$5 \times I_{\Delta N}$ is not available for $I_{\Delta N} = 1000$ mA (RCD type AC) or $I_{\Delta N} \geq 300$ mA (RCD type A, type F).

$2 \times I_{\Delta N}$ is not available for $I_{\Delta N} = 1000$ mA (RCD type A, type F).

The specified accuracy shall apply to the entire measuring range.

8.3.4 Tripping current (RCD I)

Tripping current

Norm **EN 60364-4-41**, (SETTINGS: → RCD TESTING):

The entire measuring range complies with the requirements specified in the EN 61557-6 standard.

Measuring range I_{Δ}	Resolution I_{Δ}	Accuracy
$0,1 \times I_{\Delta N} \div 1,1 \times I_{\Delta N}$ (type AC, EV/MI AC part)	$0,05 \times I_{\Delta N}$	$\pm 0,1 \times I_{\Delta N}$
$0,1 \times I_{\Delta N} \div 1,5 \times I_{\Delta N}$ (type A, $I_{\Delta N} \geq 30$ mA)	$0,05 \times I_{\Delta N}$	$\pm 0,1 \times I_{\Delta N}$
$0,1 \times I_{\Delta N} \div 2,2 \times I_{\Delta N}$ (type A, $I_{\Delta N} \geq 30$ mA)	$0,05 \times I_{\Delta N}$	$\pm 0,1 \times I_{\Delta N}$
$0,1 \times I_{\Delta N} \div 2,2 \times I_{\Delta N}$ (type B, EV/MI DC part)	$0,05 \times I_{\Delta N}$	$\pm 0,1 \times I_{\Delta N}$

Norm **EN 61008/EN 61009**, (SETTINGS: → RCD TESTING):

The entire measuring range complies with the requirements specified in the EN 61557-6 standard.

Measuring range I_{Δ}	Resolution I_{Δ}	Accuracy
$0.2 \times I_{\Delta N} \div 1.1 \times I_{\Delta N}$ (type AC, EV/MI AC part)	$0.05 \times I_{\Delta N}$	$\pm 0.1 \times I_{\Delta N}$
$0.2 \times I_{\Delta N} \div 1.5 \times I_{\Delta N}$ (type A, $I_{\Delta N} \geq 30$ mA)	$0.05 \times I_{\Delta N}$	$\pm 0.1 \times I_{\Delta N}$
$0.2 \times I_{\Delta N} \div 2.2 \times I_{\Delta N}$ (type A, $I_{\Delta N} \geq 30$ mA)	$0.05 \times I_{\Delta N}$	$\pm 0.1 \times I_{\Delta N}$
$0.2 \times I_{\Delta N} \div 2.2 \times I_{\Delta N}$ (type B, EV/MI DC part)	$0.05 \times I_{\Delta N}$	$\pm 0.1 \times I_{\Delta N}$

Tripping time

Measuring range (ms)	Resolution (ms)	Accuracy
0 ÷ 300	1	±3 ms

Contact voltage

Measuring range (V)	Resolution (V)	Accuracy
0.0 ÷ 19.9	0.1	(-0 % / +15 %) of the measured value ± 10 digits
20.0 ÷ 99.9	0.1	(-0 % / +15 %) of the measured value

The specified accuracy shall apply for stable mains voltages and protective conductor connections without any interference voltages.

Tripping current measurement is not available for $I_{\Delta N}=1000$ mA (RCD type B, type B+).

The specified accuracy shall apply to the entire measuring range.

Tripping current limits

RCD type	Tripping current	
	Lower limit	Upper limit
		$I_{\Delta N} < 30$ mA
AC (sinusoidal)	$0.5 \times I_{\Delta N}$	$I_{\Delta N}$
A, F (pulsating)	$0.35 \times I_{\Delta N}$	$2 \times I_{\Delta N}$ $1.4 \times I_{\Delta N}$
B, B+ (DC)	$0.5 \times I_{\Delta N}$	$2 \times I_{\Delta N}$

Note:

If the **EN 60364-4-41** standard has been selected (SETTINGS: → RCD testing), a tripping current of less than the lower limit will be displayed without any evaluation (~~x~~ / ✓).

8.4 Loop impedance and prospective short-circuit current

8.4.1 Zs function (for systems without RCD)

Loop impedance

Measuring range according to EN 61557-3: 0.25 Ω ÷ 9.99 kΩ

Measuring range (Ω)	Resolution (Ω)	Accuracy
0.00 ÷ 9.99	0.01	± (5 % of the measured value + 5 digits)
10.0 ÷ 99.9	0.1	
100 ÷ 999	1	±10 % of the measured value
1.00 k ÷ 9.99 k	10	

Prospective short-circuit current (calculated value)

Measuring range (A)	Resolution (A)	Accuracy
0.00 ÷ 9.99	0.01	Please observe the accuracy of the loop resistance measurement.
10.0 ÷ 99.9	0.1	
100 ÷ 999	1	
1.00 k ÷ 9.99 k	10	
10.0 k ÷ 23.0 k	100	

The accuracy specified shall apply provided that the mains voltage is stable during measurement.

Testing current (at 230 V) 6.5 A (10 ms)
 Nominal voltage range 93 V ÷ 134 V (45 Hz ÷ 65 Hz)
 185 V ÷ 266 V (45 Hz ÷ 65 Hz)

8.4.2 Zsrcd function (for systems with RCD)

Loop impedance

Measuring range according to EN 61557-3: 0.46 Ω ÷ 9.99 kΩ

Measuring range (Ω)	Resolution (Ω)	Accuracy
0.00 ÷ 9.99	0.01	±(5 % of the measured value + 10 digits)
10.0 ÷ 99.9	0.1	
100 ÷ 999	1	±10 % of the measured value
1.00 k ÷ 9.99 k	10	

Accuracy might be impaired due to interference voltages in the mains voltage.

Prospective short-circuit current (calculated value)

Measuring range (A)	Resolution (A)	Accuracy
0.00 ÷ 9.99	0.01	Please observe the accuracy of the loop impedance measurement.
10.0 ÷ 99.9	0.1	
100 ÷ 999	1	
1.00 k ÷ 9.99 k	10	
10.0 k ÷ 23.0 k	100	

Nominal voltage range 93 V ÷ 134 V (45 Hz ÷ 65 Hz)
 185 V ÷ 266 V (45 Hz ÷ 65 Hz)

No tripping of the residual current protection device (RCD).

8.5 Line impedance and prospective short-circuit current / voltage drop

Line impedance

Measuring range according to EN 61557-3: 0.25 Ω ÷ 9.99 k Ω

Measuring range (Ω)	Resolution (Ω)	Accuracy
0.00 ÷ 9.99	0.01	± (5 % of the measured value + 5 digits)
10.0 ÷ 99.9	0.1	
100 ÷ 999	1	±10 % of the measured value
1.00 k ÷ 9.99 k	10	

Prospective short-circuit current (calculated value)

Measuring range (A)	Resolution (A)	Accuracy
0.00 ÷ 0.99	0.01	Please observe the accuracy of the line impedance measurement.
1.0 ÷ 99.9	0.1	
100 ÷ 999	1	
1.00 k ÷ 99.99 k	10	
100 k ÷ 199 k	1000	

Testing current (at 230 V) 6.5 A (10 ms)

Nominal voltage range 93 V ÷ 134 V (45 Hz ÷ 65 Hz)
 185 V ÷ 266 V (45 Hz ÷ 65 Hz)
 321 V ÷ 485 V (45 Hz ÷ 65 Hz)

Voltage drop (calculated value)

Measuring range (%)	Resolution (%)	Accuracy
0.0 ÷ 99.9	0.1	Please observe the accuracy of the line impedance measurement*.

Z_{REF} measuring range 0.00 Ω ÷ 20.0 Ω

* Please refer to chapter 5.6.2 *Voltage drop* for information on how to calculate the voltage drop.

8.6 Earthing resistance

Measuring range according to EN61557-5: 2,00 Ω ÷ 1999 Ω

Measuring range (Ω)	Resolution (Ω)	Accuracy
0.00 ÷ 19.99	0.01	±(5 % of the measured value + 5 digits)
20.0 ÷ 199.9	0.1	
200 ÷ 9999	1	

Maximum auxiliary earth electrode resistance R_C ... 100× R_E or 50 k Ω (the lower value shall apply)
 Maximum probe resistance R_P 100× R_E or 50 k Ω (the lower value shall apply)
 Additional error at R_{Cmax} or R_{Pmax} ±(10 % of the measured value + 10 digits)
 Additional error at interference voltage of 3 V (50 Hz) ±(5 % of the measured value + 10 digits)
 Open-circuit voltage < 30 VAC
 Short-circuit current < 30 mA
 Frequency of testing voltage 125 Hz, sinusoidal
 Interference voltage indicating threshold 1 V (< 50 Ω , maximum)

Automatic measurement of auxiliary earth electrode resistance and probe resistance.
 Automatic monitoring of interference voltage.

8.7 TRMS voltage, frequency and phase sequence

8.7.1 TRMS voltage (AC/DC)

Measuring range (V)	Resolution (V)	Accuracy
0 ÷ 550	1	± (2 % of the measured value + 2 digits)

Measuring method true r.m.s. value (TRMS)
 Frequency range 0 Hz, 14 Hz ÷ 500 Hz

8.7.2 Voltage of the connection monitor

Measuring range (V)	Resolution (V)	Accuracy
10 ÷ 550	1	±(2 % of the measured value + 2 digits)

8.7.3 Frequency

Measuring range (Hz)	Resolution (Hz)	Accuracy
0.00 ÷ 9.99	0.01	±(0.2 % of the measured value + 1 digit)
10.0 ÷ 499.9	0.1	

Voltage range 10 V ÷ 550 V

8.7.4 Phase sequence (rotary field)

Voltage range 100 V_{AC} ÷ 550 V_{AC}
 Frequency range 14 Hz ÷ 500 Hz
 Result displayed 1.2.3 or 3.2.1

8.8 TRMS current (AC / DC) via current clamp adapter

Measuring input C1 of the installation tester:

Maximum voltage 3 V
 Frequency 0 Hz, 40 Hz ÷ 500 Hz

AC current clamp adapter BENNING CC 1 (044037)

Range = 400 A
 Output signal 1 mV AC per 1 A AC
 Frequency 50 Hz ÷ 60 Hz

Measuring range (A)	Resolution (A)	Accuracy*
0.00 ÷ 0.99	0.01	indicative
1.00 ÷ 19.99	0.01	±(3 % of the measured value + 0.5 A)
20.0 ÷ 349.9	0.1	±(3 % of the measured value + 0.5 A)
350.0 ÷ 399.9	0.1	±(5 % of the measured value + 1 A)

AC / DC current clamp adapter BENNING CC 3 (044038)

Range = 40 A
 Output signal 10 mV AC/DC per 1 A AC/DC
 Frequency 0 Hz, 40 Hz ÷ 400 Hz

Measuring range (A)	Resolution (A)	Accuracy*
0.00 ÷ 1.99	0.01	±(3 % of the measured value + 0.2 A)
2.00 ÷ 19.99	0.01	±(3 % of the measured value + 0.3 A)
20.0 ÷ 39.9	0.1	±(3 % of the measured value + 0.5 A)

Range = 300 A
 Output signal 1 mV AC/DC per 1 A AC/DC

Measuring range (A)	Resolution (A)	Accuracy*
0.00 ÷ 19.99	0.01	indicative
20.0 ÷ 39.9	0.1	
40.0 ÷ 199.9	0.1	± (4 % of the measured value + 1 A)
200.0 ÷ 299.9	0.1	± (4 % of the measured value + 2 A)

* The specified accuracy shall apply to the BENNING IT 130 installation tester and the BENNING current clamp adapters used.

8.9 Single-fault leakage current (ISFL) in IT networks

Measuring range (mA)	Resolution (mA)	Accuracy
0.0 ÷ 19.9	0.1	± (5 % of the measured value + 3 digits)

Measuring resistance..... approx. 390 Ω
 Voltage ranges 93 V ≤ U_{L1-L2} < 134 V
 185 V ≤ U_{L1-L2} ≤ 266 V

8.10 Luminous intensity

The specified accuracy shall apply to the entire measuring range and for the use of the BENNING luxmeter type B (044111).

Measuring range (lux)	Resolution (lux)	Accuracy
0.01 ÷ 19.99	0.01	± (5 % of the measured value + 2 digits)
20.0 ÷ 199.9	0.1	±(5 % of the measured value)
200 ÷ 1999	1	
2.00 ÷ 19.99 k	10	

Measuring principlesilicon photodiode with $V(\lambda)$ filter

Spectral response error< 3.8 % according to CIE curve

Cosine error.....< 2.5 % up to an angle of incidence of $\pm 85^\circ$

Overall accuracy.....corresponds to DIN 5032, class B standard

8.11 General data

Power supply voltage.....	9 V _{DC} (6×1.5 V batteries or storage batteries, type AA)
Operating time.....	typically 20 h
Input voltage of charging jack.....	12 V ± 10 %
Input current of charging jack.....	max. 400 mA
Storage battery charging current	250 mA (internally regulated)
Measuring category	1000 V CAT II to earth 600 V CAT III to earth 300 V CAT IV to earth
Protection class	double insulation
Contamination level.....	2
Protection category.....	IP 40
Display	matrix display with 128 x 64 pixels and background lighting
Dimensions (w × h × d).....	23 cm × 10.3 cm × 11.5 cm
Weight	1.3 kg, without batteries / storage batteries
Reference conditions:	
Temperature range.....	+10 °C ÷ +30 °C
Air humidity range.....	40 % rel. Air humidity ÷ 70 % rel. air humidity
Operating conditions:	
Temperature range.....	0 °C ÷ +40 °C
Maximum relative air humidity	95 % rel. air humidity (0 °C ÷ 40 °C), non-condensing
Storage conditions:	
Temperature range.....	-10 °C ÷ +70 °C
Maximum relative air humidity	90 % rel. air humidity (-10 °C ÷ +40 °C) 80 % rel. air humidity (40 °C ÷ 60 °C)
Transmission speed (baud rate):	
RS232 interface.....	57600 baud
USB interface	256000 baud
Memory size	up to 1800 measurements

The specified accuracy shall apply to the first year of use under reference conditions. If not specified otherwise for the respective measuring function, an additional error of max. + 1 % of the measured value + 1 digit has to be considered for the use under operating conditions.

Appendix A Fuse table – Prospective short-circuit current

Fuse, utilization category gL / gG

gG: general-purpose fuse for general applications, mainly for cable and line protection

gL: former VDE utilization category, replaced by gG

Nominal current (A)	Disconnection time [s]				
	35m	0.1	0.2	0.4	5
	Minimum prospective short-circuit current (A)				
2	32.5	22.3	18.7	15.9	9.1
4	65.6	46.4	38.8	31.9	18.7
6	102.8	70	56.5	46.4	26.7
10	165.8	115.3	96.5	80.7	46.4
16	206.9	150.8	126.1	107.4	66.3
20	276.8	204.2	170.8	145.5	86.7
25	361.3	257.5	215.4	180.2	109.3
35	618.1	453.2	374	308.7	169.5
50	919.2	640	545	464.2	266.9
63	1217.2	821.7	663.3	545	319.1
80	1567.2	1133.1	964.9	836.5	447.9
100	2075.3	1429	1195.4	1018	585.4
125	2826.3	2006	1708.3	1454.8	765.1
160	3538.2	2485.1	2042.1	1678.1	947.9
200	4555.5	3488.5	2970.8	2529.9	1354.5
250	6032.4	4399.6	3615.3	2918.2	1590.6
315	7766.8	6066.6	4985.1	4096.4	2272.9
400	10577.7	7929.1	6632.9	5450.5	2766.1
500	13619	10933.5	8825.4	7515.7	3952.7
630	19619.3	14037.4	11534.9	9310.9	4985.1
710	19712.3	17766.9	14341.3	11996.9	6423.2
800	25260.3	20059.8	16192.1	13545.1	7252.1
1000	34402.1	23555.5	19356.3	16192.1	9146.2
1250	45555.1	36152.6	29182.1	24411.6	13070.1

Line safety switch, tripping characteristic B

Range of instantaneous tripping: 3 - 5 x I_N

Nominal current (A)	Disconnection time [s]				
	35m	0.1	0.2	0.4	5
	Minimum prospective short-circuit current (A)				
6	30	30	30	30	30
10	50	50	50	50	50
13	65	65	65	65	65
15	75	75	75	75	75
16	80	80	80	80	80
20	100	100	100	100	100
25	125	125	125	125	125
32	160	160	160	160	160
40	200	200	200	200	200
50	250	250	250	250	250
63	315	315	315	315	315

Line safety switch, tripping characteristic C

Range of instantaneous tripping: 5 - 10 x I_N

Nominal current (A)	Disconnection time [s]				
	35m	0.1	0.2	0.4	5
	Minimum prospective short-circuit current (A)				
0.5	5	5	5	5	2.7
1	10	10	10	10	5.4
1.6	16	16	16	16	8.6
2	20	20	20	20	10.8
4	40	40	40	40	21.6
6	60	60	60	60	32.4
10	100	100	100	100	54
13	130	130	130	130	70.2
15	150	150	150	150	83
16	160	160	160	160	86.4
20	200	200	200	200	108
25	250	250	250	250	135
32	320	320	320	320	172.8
40	400	400	400	400	216
50	500	500	500	500	270
63	630	630	630	630	340.2

Line safety switch, tripping characteristic KRange of instantaneous tripping: 8 - 14 x I_N

Nominal current (A)	Disconnection time [s]				
	35m	0.1	0.2	0.4	
	Minimum prospective short-circuit current (A)				
0.5	7.5	7.5	7.5	7.5	
1	15	15	15	15	
1.6	24	24	24	24	
2	30	30	30	30	
4	60	60	60	60	
6	90	90	90	90	
10	150	150	150	150	
13	195	195	195	195	
15	225	225	225	225	
16	240	240	240	240	
20	300	300	300	300	
25	375	375	375	375	
32	480	480	480	480	

Line safety switch, tripping characteristic DRange of instantaneous tripping: 10 - 20 x I_N

Nominal current (A)	Disconnection time [s]					
	35m	0.1	0.2	0.4	5	
	Minimum prospective short-circuit current (A)					
0.5	10	10	10	10	2.7	
1	20	20	20	20	5.4	
1.6	32	32	32	32	8.6	
2	40	40	40	40	10.8	
4	80	80	80	80	21.6	
6	120	120	120	120	32.4	
10	200	200	200	200	54	
13	260	260	260	260	70.2	
15	300	300	300	300	81	
16	320	320	320	320	86.4	
20	400	400	400	400	108	
25	500	500	500	500	135	
32	640	640	640	640	172.8	

Appendix B Standard and optional accessories for specific measuring functions

The table below lists recommended standard and optional accessories required for specific measurements. Please refer to chapter 3.5 for further information on standard and optional accessories.

Measuring function	Appropriate accessories (accessories with item no. are optional)
Insulating resistance	<ul style="list-style-type: none"> <input type="checkbox"/> universal three-wire test cable <input type="checkbox"/> "Commander" test probe (switchable by means of "TEST" key)
Low-impedance resistance Continuity test	<ul style="list-style-type: none"> <input type="checkbox"/> universal three-wire test cable <input type="checkbox"/> "Commander" test probe (switchable by means of "TEST" key) <input type="checkbox"/> 40 m measuring line BENNING TA 5 (044039)
Line impedance (voltage drop) Loop impedance	<ul style="list-style-type: none"> <input type="checkbox"/> universal three-wire test cable <input type="checkbox"/> test cable with shock-proof plug <input type="checkbox"/> "Commander" test plug for shock-proof socket (switchable by means of "TEST" key) (044149) <input type="checkbox"/> "Commander" test probe (switchable by means of "TEST" key)
RCD testing	<ul style="list-style-type: none"> <input type="checkbox"/> universal three-wire test cable <input type="checkbox"/> test cable with shock-proof plug <input type="checkbox"/> "Commander" test plug for shock-proof socket (switchable by means of "TEST" key) (044149)
Earthing resistance	<ul style="list-style-type: none"> <input type="checkbox"/> universal three-wire test cable <input type="checkbox"/> earthing kit consisting of two earth rods, three test cables (044113)
Phase sequence (rotary field)	<ul style="list-style-type: none"> <input type="checkbox"/> universal three-wire test cable <input type="checkbox"/> 16 A CEE measuring adapter, 5-pin, for voltage / rotary field measurement (044148)
Voltage, frequency	<ul style="list-style-type: none"> <input type="checkbox"/> universal three-wire test cable <input type="checkbox"/> "Commander" test probe (switchable by means of "TEST" key) <input type="checkbox"/> test cable with shock-proof plug <input type="checkbox"/> "Commander" test plug for shock-proof socket (switchable by means of "TEST" key) (044149)
Current	<ul style="list-style-type: none"> <input type="checkbox"/> AC current clamp adapter BENNING CC 1 for current measurement up to 400 A AC (044037) <input type="checkbox"/> AC / DC current clamp adapter BENNING CC 3 for current measurement up to 300 A AC / DC (044038)
Luminous intensity	<ul style="list-style-type: none"> <input type="checkbox"/> luminous intensity sensor BENNING luxmeter type B (044111)
Single-fault leakage current (ISFL) in IT networks	<ul style="list-style-type: none"> <input type="checkbox"/> universal three-wire test cable <input type="checkbox"/> test cable with shock-proof plug <input type="checkbox"/> "Commander" test plug for shock-proof socket (switchable by means of "TEST" key) (044149) <input type="checkbox"/> "Commander" test probe (switchable by means of "TEST" key)

Appendix C "Commander" test probe, "Commander" test plug

C.1 Safety warnings

Measuring categories of the "Commanders"

"Commander" test probe (switchable by means of "TEST" key)

without attachable protective cap, 18 mm tip: CAT II 1000 V to earth

with attachable protective cap, 4 mm tip: CAT II 1000 V / CAT III 600 V / CAT IV 300 V to earth

Optional accessories:

"Commander" test plug for shock-proof socket (switchable by means of "TEST" key)

Item no.: 044149 CAT II 300 V to earth

- The measuring categories of the "Commanders" might be lower than the measuring category of the installation tester.
- If the phase voltage is detected at the protective conductor connection (PE), immediately stop all measurements and make sure that the fault will be eliminated.
- Before replacing the batteries / storage batteries or opening the battery compartment cover, disconnect the "Commander" both from the installation tester and from the installation.
- For repairs or service, please contact your specialty retailer or the BENNING Service Center.

C.2 Batteries

The "Commanders" can be operated with of two alkaline batteries or two rechargeable NiMh batteries (storage batteries) of size AAA. The usual operating time is approximately 40 hours and shall apply to a capacity of at least 850 mAh.

Notes:

- If the "Commanders" are not used for a longer period of time, remove all batteries / storage batteries from the battery compartment.
- Use alkaline batteries or rechargeable NiMh batteries of size AAA only! When using rechargeable storage batteries, it is recommended to observe a minimum capacity of 850 mAh.
- Please make sure that the batteries / storage batteries are inserted with correct polarity, because otherwise the "Commander" cannot be operated and the batteries / storage batteries will discharge.

C.3 Description of the "Commanders"

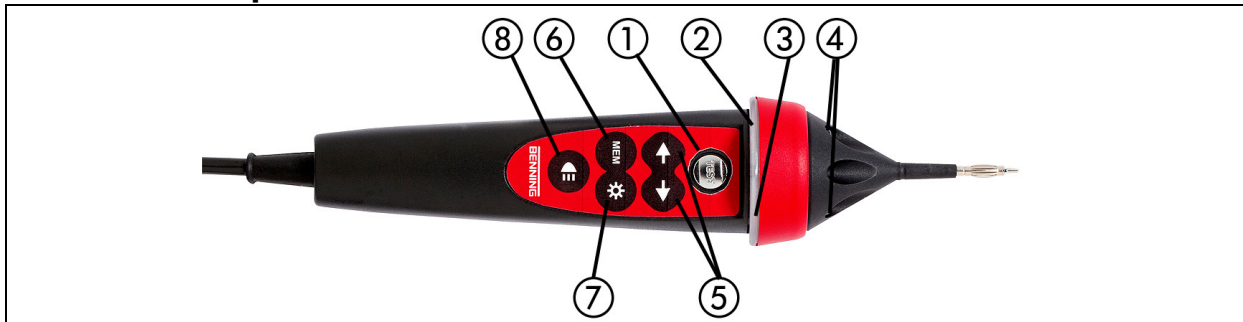

Figure C.1: Front of "Commander" test probe (switchable by means of "TEST" key)

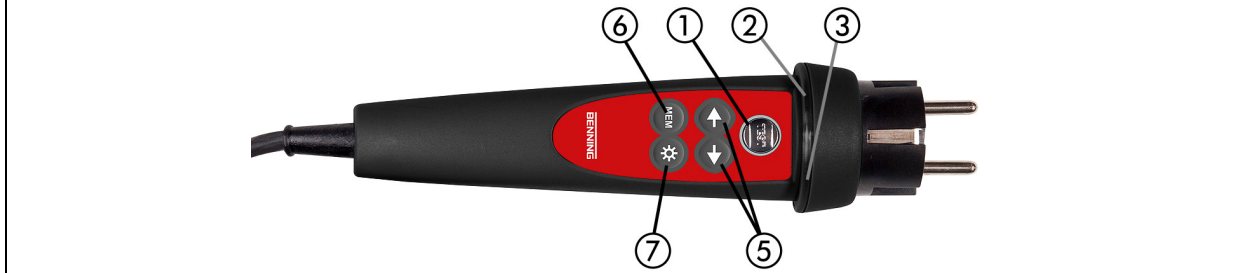

Figure C.2: Front of the optional "Commander" test plug for shock-proof socket (switchable by means of "TEST" key) (044149)

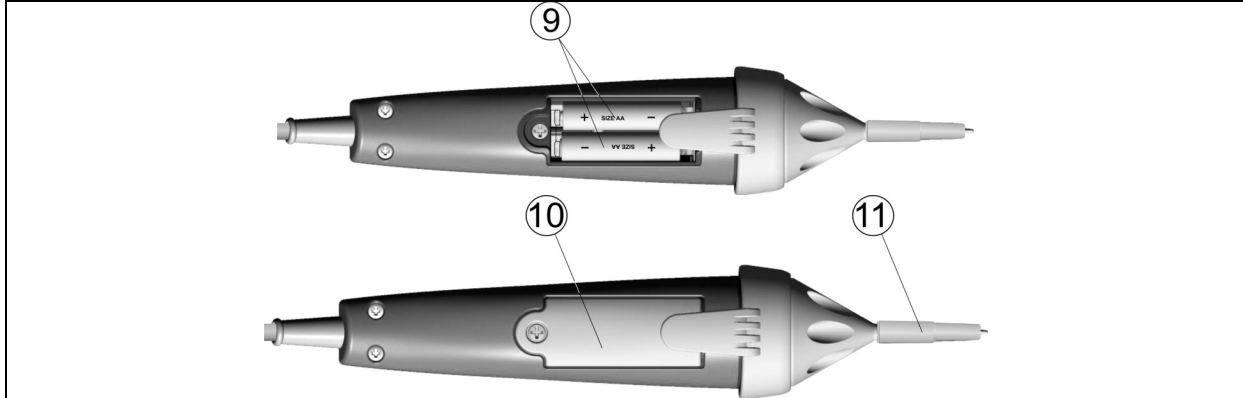

Figure C.3: Rear of the "Commander" test probe

Caption:

1	TEST	Start of measurement
2	LED	PE contact electrode for protective conductor connection
3	LED	Left status RGB LED
4	LEDs	Right status RGB LED
5	Function selector keys	LEDs of the measuring point illumination
6	MEM	Selection of the measuring function (only in the "AUTO" switch position)
7	LCD illumination	Storage / recall of measuring results
8	Measuring point illumination	Switches on / off the LCD illumination of the installation tester
9	Batteries / storage batteries	Switches on / off the measuring point illumination
10	Battery compartment cover	Size AAA, alkaline batteries or NiMH storage batteries
11	Protective cap	Battery compartment cover
		Detachable protective cap, CAT IV 300 V

C.4 LED indications of the "Commanders"

Both LEDs yellow	Warning! Phase voltage at the PE connection of the "Commander"! Only indicated, if the silver "TEST" key of the "Commander" is touched for > 1 second!
Right LED red	Measuring result outside the preset limiting values
Right LED green	Measuring result inside the preset limiting values
Left LED is flashing blue	"Commander" is monitoring the input voltage
Left LED orange	Voltage between testing terminals is higher than 50 V
Both LEDs are flashing red	Battery voltage of the "Commander" is low
Both LEDs red and "Commander" switches off	Battery voltage too low to operate the "Commander"

How to test the protective conductor connection (PE)

- ❑ Select the **Z_L (L-N/L)** (English: Z_{LINE}), **Z_S (L-PE)** (English: Z_{LOOP}) or **FI/RCD** function by means of the function selector switch.
- ❑ Connect the optional "Commander" test plug (044149) to the test object (see figure C.4).
- ❑ Touch the silver contact electrode of the "TEST" key of the "Commander" for at least one second.
- ❑ If the phase voltage is detected at the PE connection of the "Commander", the LEDs of the "Commander" will light yellow. In addition, the  warning is shown on the LC display of the installation tester and the buzzer sounds. Further measurements must be stopped immediately!

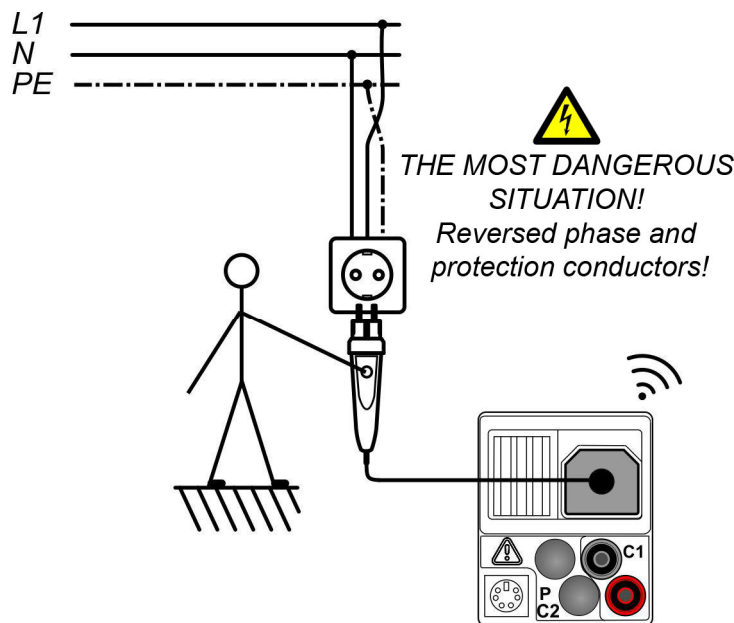

Figure C.4: Reversed L and PE conductors – Phase voltage at the PE connection is detected by touching the "TEST" key of the optional "Commander" test plug (044149).